



Auto Lift Arm Adapters, Height Extensions, Rubber Pads, Saddles and Adapters

BY MAKE AND MODEL

ABOVE-GROUND LIFT • IN-GROUND LIFT

Automotive Shop Equipment | Auto Lift Repair Parts

The Industry's Largest Selection of Auto Lift Repair Parts

DIRECTFIT™
DIRECT FIT™ BRAND



SVI International, Inc.

155 Harvestore Drive • DeKalb, IL 60115

800-321-8173

815-748-0200

www.sviinternational.com



Including Specialty Adapters for 2019, 2020, and newer Chevrolet 1500 Silverado and GMC Sierra Truck models, and More!

SVI knows custom.



DIRECT FIT™ BRAND

SVI International, Inc.

Catalogs and Information Online: www.sviinternational.com

AUTO LIFT REPAIR PARTS FOR ALL MAKES & MODELS ~NO MATTER THE AGE OF THE LIFT!

- Arm Restraint Kits & Parts
- Cables—Lifting and Equalizing
- Chain
- doorjammerPRO - Door Protection Pad
- Height Extensions and Rubber Pads
- Installation Products & Tools
- Power Units and Parts
- Pulleys and Chain Rollers
- Seal Kits for In-Ground & Surface Mount
- Safety Legs / Non-Rotators
- Replacement Lift Kits
- Power Post Lifting Systems
- Tanks for In-Ground Lifts
- Turf Attachments for 2-Post Lifts

SURFACE MOUNT LIFT PARTS FOR:

Acanus	Gemini	Quality
Ammco**	Gilbarco	Ranger
Alamo /	Globe	Ravaglioli
ASSSA	Grand	Rotary Lifts
ALM	Hofmann	Silent Tech
AMI	Hydralift	Slift
Ashawa	Ime Istobal	Somers Souriau
Ben Pearson	Kismet	Stenhoj
BendPak	Kimm	Stertil Koni
Benwil	Koni	Sun
Bishamon	Launch	Tecalemit
Boston	Laycock	Titan
Bradbury	Lincoln	Weaver
Cascos	Maha	Werther
Consul	Manitowoc Lifts	Western
Challenger	Mohawk	Westinghouse
Force	Nussbaum	Wheeltronic
Ford Smith	OMA	Worth
Forward	OMCN	Zippo
Fuchs/Zippo	PMW	

IN-GROUND LIFT PARTS FOR:

Benwil	Gilbarco	PKS Lifts
Challenger	Globe	Rotary
Cochin	HDL/ISS Innovative	US Hoist
Curtis	Joyce	Weaver
Ford Smith	Manitowoc Lifts	Western

AIR COMPRESSOR PARTS

- Air Receiver Tanks • Compressor Mufflers
- Automatic Tank Drain Valve for Champion Compressors
- Filters—Many OEM Ref Available!
- Filters, Regulators, Lubricators
- Intake Filter Products
- Milton Air System Products
- Re-Coil Hose • Valves
- Vibration Dampening Pads & much more!

BRAKE LATHES REPAIR PARTS

- Brake Lathe Repair Parts and Accessories for All Makes

EXHAUST REMOVAL SYSTEMS & PRODUCTS

FLUID DELIVERY SYSTEMS

- Lenz Fittings
- Steel Hydraulic Line Tubing and Fittings
- Strut and Hangers

HOSE REELS

HYDRAULIC CYLINDERS

- Custom Single-Acting Large Bore Cylinders
- Also see "Lifting Equipment"

LIFTING EQUIPMENT

- New In-Ground Lifts—Car, Truck & Bus
- Small Equipment Shop Maintenance (SESM) Lifts for lifting Landscape Equip. ATVs / UTVs, Motorcycles, Lawn Mowers, Golf Carts and More!
- Custom Lifting Equipment incl. Production Line Lifts, Rail Car Lifts and More
- Custom Hydraulic Cylinders for Various Applications
- Turf Attachments for 2-Post Lifts
- In-Ground Lift Sections and Kits
- And more!

EASY TO ORDER:
 800-321-8173
 815-748-0200
 Fax: 800-899-1784 • 815-748-0210
E-Mail: parts@sviintl.com
www.sviinternational.com

LUBRICATION & PAINT / FOAM SPRAY REPAIR PARTS & KITS FOR:

- Alemite • ARO • Balcrank • Graco • Lincoln

PETROLEUM EQUIPMENT & REPAIR PARTS FOR:

- Gas Pump & Meter Kits and Parts for Gasboy • Tokheim • Fill-Rite
- Including Parts for Older Pumps: Wayne • Bennett • Gilbarco • Bowser A.O. Smith (Geosource) • Southwest

HYDRAULIC SEALS AND KITS

SHOP EQUIPMENT

- Hein-Werner Products • Omega Products
- Porto-Power • Pro-Lift

TIRE EQUIPMENT REPAIR PARTS • Tire Changer and Wheel Balancer Parts for All Makes

Accu-Turn	Coats**	John Bean /	Sicam
All Tool	Corgh	(JBC)	Sice
Ammco**	FMC	Kwik-Way	Snap-On
BaseLine**	Giuliano	Launch	Teco
Bosch	Hofmann	Nussbaum	Tuxedo
Cemb	Hunter	Ranger	

VALVES

- Air Compressor Valves of All Types
- Air and Hoist Control Valves • Ball Valves
- Check Valves • Kingston Valves
- Pressure Relief Valves • Relief Valves
- Safety Valves • Solenoid Valves
- Tire Changer Valves • And More!

CUSTOM PRODUCTS

And let us know if you want something you use in your shop to be added to our product line!



In addition to SVI's DIRECT FIT™ BRAND, we are proud to be a one-stop shop for many other great products including:



2 Ready-Ship Warehouses for Faster Shipping! | CHICAGO • LOS ANGELES

Main Office: 155 Harvestore Drive • DeKalb, IL 60115

All names, numbers, symbols and descriptions are used for reference purposes only. It is not implied that any part listed is the product of these manufacturers. 01.10.2024

SVI does not represent and is not associated in any way with any other companies. Entire contents copyright © January 10, 2024 3:27 PM, SVI International, Inc. Prices subject to change without notice.

**AMMCO, BASELINE, COATS and DUCKHEAD are registered trademarks of Hennessy Industries, Inc. SVI International, Inc. is not associated in any way with Hennessy Industries, Inc.



TABLE OF CONTENTS

SVI Line Card 2

Adapter Type / Style Picture Reference..... 5-7

SVI Vast Product Line Featured 8-9

Auto Lift Arm Adapters, Height Extensions, Rubber Pads, Saddles and Adapters— Custom Options, too 8-9

Auto Lift Pads Quick Reference..... 13-22

Height Extensions and Adapters by Type / Style

 **Outer Arm Adapters**..... 23

 **Adapters for Low Rise and Mid Rise Stack Pads, ALRPR, ALRPR, LRPS, ALRPS** .. 23

 **LDH • Slip-Over Fixed Height Extension with Octagon Pad** 24-25

 **ALDH • Slip-Over Adjustable Height Extension with Octagon Pad** 26-27

 **LDR • Slip-Over Fixed Height with Rectangle Pad**..... 28

 **HDR • Slip-Over Fixed Height Extension with Rectangle Pad**..... 29-30

 **AHDR • Slip-Over Adjustable Height Extension with Rectangle Pad**..... 31-32

 **HDRNRW • Narrow Slip-Over Fixed Height Extension** 33

 **AHDRNRW • Narrow Slip-Over Adjustable Height Extension** 36-38

 **LDRND • Slip-Over Fixed Height Extension with 5” Round Pad** 39

 **ALDRND • Slip-Over Adjustable Height Extension with 5” Round Pad** 40

Height Extensions and Adapters by Type / Style
(continued)

 **ARND • Slip-Over Fixed Height Extension with 6” Round Rubber Pad**..... 41

 **AARND • Slip-Over Adjustable Height Extension with 6” Round Rubber Pad** 41

 **Slip-Over Height Extensions with Square Pad** 42-43

 **NS • Nesting Style Fixed Height Extension** 44-51

 **NSP • Nesting Style Fixed Height Extension With Pad** 52-56

 **NSPNRW • Nesting Style Narrow Fixed Height Extension with Pad**..... 56

 **NSPSUA • Nesting Style Adjustable Height Extension with Rectangle Pad** 57

 **SUH5 • Screw-Up Adapters with 5” or 5-1/2” Square Top with Corners Turned Up** 58

 **SUH6 • Screw-Up Adapters with 6” Square Top with Corners Turned Up** 59

 **SUH 3-7/8” X 5” • Screw-Up Adapters with 3-7/8” x 5” Rectangle Top** 60

 **SUR5 • Screw-Up Adapter with 5” Round Pad** 61

 **SUR6 • Screw-Up Adapter with 6” Round Pad** 62

 **SURX • Screw-Up Adapter with X-Pattern Rectangle Pad**..... 63

 **Spin-Up and Telescoping Adapters with Nut / Collar (Pad Style Varies)**..... 64-66

 **GMT • Specialty Wide-Style Adapters for 2019, 2020, and newer Chevrolet 1500 Silverado and GMC Sierra Trucks** 67-75

Table of Contents continues on next page



TABLE OF CONTENTS

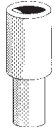

Additional Height Extensions and Adapters

For Alamo / ASSSA Lifts.....	76
For ALM Lifts.....	77-78
For Ammco®* Lifts.....	79
For Atlas Lifts.....	80
For Ben Pearson.....	81
For BendPak.....	82-83
For Benwil.....	84-87
For Bishamon.....	84-87
For Challenger Lifts.....	88-98
For Direct Lifts.....	99
For Force Lifts.....	100
For Ford Smith Lifts.....	104-111
For Forward Lifts.....	103
For Gilbarco.....	117-118
For Globe Lifts and Ford Smith.....	104-111
For Grand Lifts.....	112
For Hofmann.....	113
For Hydra-Lift.....	114
For Launch Lifts.....	115
For Magnum Lifts.....	116
For Manitowoc Lifts and Gilbarco Lifts.....	117-118
For Mohawk Lifts.....	119-120
For Nussbaum Lifts.....	122
For PMW Lifts.....	123
For Powerrex Lifts.....	124
For Quality Lifts.....	125-128
For Rotary Lifts.....	129-142
For Stenhoj.....	143
For Tuxedo Lifts.....	144
For W-K Rolling Bridge Jacks.....	145
For Weaver Lifts.....	146
For Werther Lifts.....	147
For Western Hoist.....	148-149
For Wheeltronic Lifts.....	150-153

Height Extensions and Adapters By Size

Drop-In Style by Pin / Collar / Nut OD

1-1/8" Pin OD.....	154
1-1/4" Pin OD.....	155-156
1-3/8" Pin OD / (35mm).....	157-158
1-1/2" Pin OD.....	159-161
1.575" Pin OD / (40mm).....	162
1-3/4" Pin OD.....	162
2" Pin OD.....	163
2-1/8" Pin OD.....	164
2-1/4" Pin OD.....	164
2-3/8" Pin OD / (60mm).....	165-166
2-7/16" Pin OD.....	167
2-3/4" Pin OD.....	168
3-1/8" Pin OD.....	169

Screw-Up Style with Threads:



1"-8 Threads.....	170
1-1/8"-7 Threads.....	170
1-1/4"-7 Threads.....	171
1-3/8"-4 Acme Threads.....	172
1-3/8"-6 Threads.....	173-174
1-1/2"-6 Threads.....	175
1-3/4"-5 Threads.....	175
2"-4.5 UNC 2A Threads.....	176

Slip-On Style By Base Opening Dimensions:

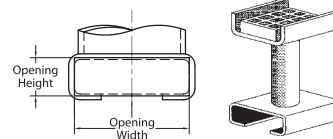

3-3/8" x 1-5/16".....	177
3-3/4" x 1-1/4".....	178
4-1/8" x 3/4".....	179
4-3/16" x 13/16".....	180
4-3/16" x 1-1/8".....	181
4-1/4" x 3/4".....	182
4-1/4" x 1-1/8".....	183
4-9/16" x 1-3/16".....	184
4-2/3" x 1".....	185-186
5-1/8" x 1".....	186
5-1/8" x 1-5/16".....	187-188
5-3/16" x 3/4".....	189-190
5-3/16" x 25/32.....	191
5-1/4" x 1/2".....	192-193
5-3/8" x 1-1/8".....	194-195
5-5/8" x 1-13/16".....	196
5-3/4" x 15/16".....	197
6-1/8" x 1".....	198-199
6-1/2" x 1-5/16".....	200-201

P
a
g
e



Don't see what you need? We have more height extensions and pads available.

We can also accommodate your special order! Call an SVI Rep today! 800-321-8173







Adapter Type / Style Picture Reference

Each Style Offers Various Dimensions / Measurements Depending on the Application

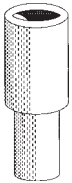
 <p>6-5/16" OD Pad</p> <p>6" OD Pad</p> <p>◀ ARND Fixed Style AARND Adjustable Style ▶</p> <p>Features Round Rubber Pad BH-7150-02 For ALM</p>	 <p>4-15/16" OD Pad</p> <p>4-15/16" OD Pad</p> <p>◀ LDRND Fixed Style ALDRND Adjustable Style ▶</p> <p>Features Round Rubber Pad BH-7450-02 For Force, Hydra-Lift, Nussbaum, Phoenix</p>
 <p>GMT Specialty Adapters - 7" Lifting Area</p> <p>Features Rectangle Rubber Pad BH-7542-75P Note: Pin / Collar, Threads, Base Varies. Specialty Adapters for Lifting 2019, 2020, 2021, and newer Chevy 1500 Silverado and GMC Sierra Trucks</p>	 <p>LDM Fixed Style - Without Pad</p> <p>For ALM, American, Ammco*, Benwil, Bishamon, Eagle, Force, Ford Smith, Gilbarco, Globe, Grand, Hydra-Lift, Manitowoc Lifts, Nussbaum, VBM, Western, and Worth</p>
 <p>◀ HDR Fixed Style AHDR Adjustable Style ▶</p> <p>Features Rectangle Rubber Pad BH-7205 For ALM, Ammco* (new), Benwil, Bishamon, Challenger, Force, Ford Smith, Forward, Gilbarco, Globe, Hydra-Lift, Magnum, Manitowoc Lifts, Nussbaum, Phoenix, VBM (old square and hex/octagon), Western</p>	 <p>LDR Fixed Style</p> <p>Features Rectangle Rubber Pad BH-7205 For American (old / new), Benwil, Bishamon, Eagle (old / new), Ford Smith, Globe, Grand (old / new), Hydra-Lift, Manitowoc Lifts, Nussbaum, Force, Western, Worth (old)</p>
 <p>5", 5-1/2" or 6" Top</p> <p>5", 5-1/2" or 6" Top</p> <p>◀ LDH Fixed Style ALDH Adjustable Style ▶</p> <p>Features Octagon "Hex" Rubber Pad (varies) For ALM, Alamo / ASSSA, American, Ammco* (new), Benwil, Bishamon, Challenger, Eagle, Force, Ford Smith (AFO), Forward, Grand, Gilbarco, Globe, Hydra-Lift, Magnum, Manitowoc Lifts, Nussbaum, Phoenix, VBM (old square and hex/octagon), Western</p>	 <p>Frame Fuel Tank Brake Lines</p> <p>Frame Fuel Tank Brake Lines</p> <p>Adjustable</p> <p>▲ HDRNRW Fixed Style AHDRNRW Adjustable Style ▶</p> <p>For Close-to-Frame Obstructions Commonly sold for use on the rear of late model trucks. Avoids denting or puncturing fuel tank and smashing brake lines.</p> <p>Features Narrow Rectangle Rubber Pad For ALM, American, (old/new), Ammco* (new), Benwil, Bishamon, Challenger, Eagle (old/new), Force, Ford Smith, Forward, Gilbarco, Globe, Grand (old/new), Hydra-Lift, Manitowoc Lifts, Nussbaum, Phoenix, VBM (old square and hex/octagon), Western, Worth (old/new)</p>
 <p>6-5/16" OD Pads</p> <p>6-5/16" OD Pads</p> <p>◀ LRPR Fixed Style ALRPR Adjustable Style ▶</p> <p>Features (2) Round Rubber Pad BH-7150-02 For Most Low Rise, Pad, and Scissor Lifts</p>	 <p>6" Top</p> <p>6" Top</p> <p>◀ LRPS Fixed Style ALRPS Adjustable Style ▶</p> <p>6" Square Top with Corners Turned Up</p> <p>Features (2) Round Rubber Pad BH-7150-02 For Most Low Rise, Pad, and Scissor Lifts</p>

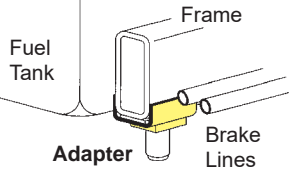
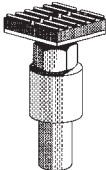
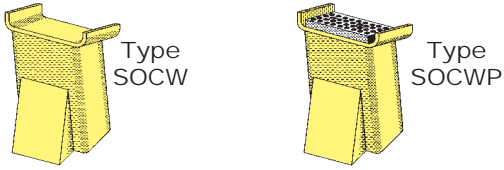
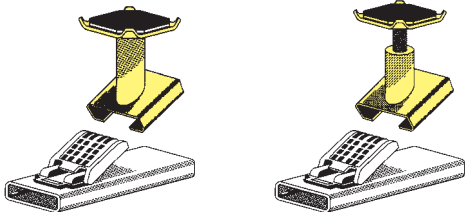
Adapter Type / Style Picture Reference

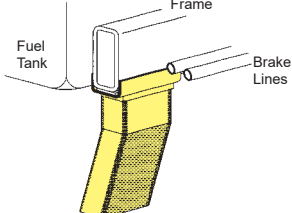
Each Style Offers Various Dimensions / Measurements Depending on the Application

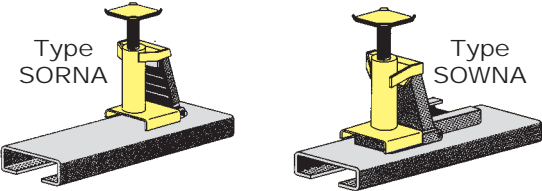
 <p>NS Fixed Style For Any Lift using Nesting Style Extensions and Adapters</p>	 <p>NSP Various Pad Styles For Any Lift using Nesting Style Extensions and Adapters</p>
 <p>NSPNRW Narrow Nesting Fixed Style For Close-to-Frame Obstructions Features Rectangle Rubber Pad BH-9900-10A For Any Lift using Nesting Style Extensions and Adapters</p>	 <p>NSPSUA Adjustable Style Features Rectangle Rubber Pad BH-7101-00 For Any Lift using Nesting Style Extensions and Adapters</p>
 <p>SOCW Drop-On Style for Flip-Ups - Without Pad SOCWP Drop-On Style for Flip-Ups - With Pad Features Rectangle Rubber Pad BH-9900-10 For Challenger and Weaver Flip-Up Adapters</p>	 <p>SOGP Drop-On Angled for Flip-Ups - Fixed Style SOGPA Drop-On Angled for Flip-Ups - Adjustable Style Features Octagon "Hex" Rubber Pad BH-7225-01 For Gilbarco, Globe, and Manitowoc Lifts. For use with Flip-Up Adapters.</p>
 <p>SOM Drop-On Style for Flip-Ups - Without Pad SOMP Drop-On Style for Flip-Ups - With Pad SOMP Features Rectangle Rubber Pad BH-9900-10 For Ford Smith, Gilbarco, Globe, Manitowoc Lifts, and Western. For use with Flip-Up Adapters</p>	 <p>SONRW Slip-Over Narrow For Close-to-Frame Obstructions Features Rectangle Rubber Pad For Challenger and Weaver</p>
 <p>SOR Drop-On Style for Flip-Ups - Without Pad SORP Drop-On Style for Flip-Ups - With Pad SORP Features Rectangle Pad BH-9755-50-1 For Rotary Lifts with Flip-Up Adapters</p>	 <p>SORNA / SOWNA Slip-Over Adjustable Features Octagon "Hex" Pad BH-7235-90AX For Rotary and Wheeltronic (SORNA), and Western (SOWNA). Fits over Flip-Up Adapters</p>

Adapter Type / Style Picture Reference

Each Style Offers Various Dimensions / Measurements Depending on the Application

<p>4-7/8" x 3-7/8" OD Rubber Pad</p> <p>Type SPR1 SPW1</p> <p>Type SPR</p> <p>Type ASPR</p> <p>SPR1 Low-Profile Protector Pad SPR Protector Pad ASPR Adjustable Style</p> <p>Features Rectangle Rubber Pad BH-7101-00 For Rotary (SPR / ASPR Series) and Western (SPW Series) Flip-Up Adapters</p>	<p>4-7/8" x 3-7/8" OD Rubber Pad</p> <p>Type SPCW1</p> <p>Type SPCW</p> <p>Type ASPCW</p> <p>SPCW1 Low-Profile Protector Pad SPCW Fixed Style ASPCW Adjustable Style</p> <p>Features Rectangle Rubber Pad BH-7101-00 For Challenger and Weaver Flip-Up Adapters</p>
<p>5", 5-1/2" or 6" Top</p> <p>SUH5 Spin-Up with 5" or 5-1/2" Top SUH6 Spin-Up with 6" Top</p> <p>Features Octagon "Hex" Rubber Pad BH-7235-90A Any Lift using 1-1/4"-7 or 1-3/8"-6 or 1-3/8"-4 ACME Threads. Lengths from 4" to 10" for SUH5 and 4" to 12" for SUH6.</p>	<p>SUH3-7/8" x 5" Spin-Up with Rectangle 3-7/8" x 5" Top</p> <p>Features Rectangle Rubber Pad BH-7101-00 Any Lift using 1-1/4"-7 or 1-3/8"-6 or 1-3/8"-4 ACME Threads Lengths from 4" to 10".</p>
<p>4-15/16" OD Pad</p> <p>SUR5 Spin-Up with 4-15/16" Round Pad</p> <p>Features Round Rubber Pad BH-7150-02 Any Lift using 1"-8, 1-1/4"-7 or 1-3/8"-6 or 1-3/8"-4 ACME Threads Lengths from 4" to 10".</p>	<p>SUNRW Narrow Spin-Up Style For Close-to-Frame Obstructions Any lift using 1-1/8"-7, 1-1/4"-7, or 1-3/8"-6 threads or 1-3/8"-4 ACME. Length from 4" to 10"</p> <p>Adapter</p> <p>Fuel Tank</p> <p>Frame</p> <p>Brake Lines</p>
<p>6-5/16" OD Pad</p> <p>SUR6 Spin-Up with 6-5/16" Round Pad</p> <p>Features Round Rubber Pad BH-7150-02 Any Lift using 1-1/4"-7 or 1-3/8"-6 or 1-3/8"-4 ACME Threads Lengths from 4" to 10".</p>	<p>4-1/2" x 4" Pad</p> <p>SURX Spin-Up with X-Pattern Pad</p> <p>Features Rectangle Rubber Pad BH-7750-02 Any lift using 1"-8, 1-1/4"-7, or 1-3/8"-6 threads or 1-3/8"-4 ACME. Lengths up to 10".</p>
<p>Truck Adapters for Benwil Lifts</p> <p>Features Round Rubber Pad BH-7150-02 Various Truck Adapters and Pick-Up Pad Assemblies for Benwil Lift Models.</p>	

Don't see what you need? We have more height extensions and pads available. We can also accommodate your special order! Call an SVI Rep today! 800-321-8173



SVI's Product Line is Vast

CONTACT US TODAY IF THERE'S SOMETHING YOU CAN'T FIND

800-321-8173 • 815-748-0200 • www.sviinternational.com



Shims for 3/4" Wedge and Screw Anchors

Color Coded Shims are In-Stock! Order Today!

BH-7512-92 Assortment 150 Shims (50 each)

BH-7512-90 1/16" Blue Pack of 50

BH-7512-91 1/8" Red Pack of 50

BH-7512-89 1/4" Black Pack of 50

HEAVY DUTY PLASTIC SLOTTED SHIMS

Extra-thick shims make it easy to level and align 2- and 4-post surface mount lifts. These rugged plastic shims will not corrode, rot or rust. A must-have for every professional lift installer in the industry.



Installation Kits Available

Installation Supplies

- Carbide Drill Bits
- Core Bits
- Epoxy and Adhesives
- Wedge Anchors
- Screw Anchors
- Rebar Cutters and Adapter
- Rod Seal Install Tools
- Safety & Inspection Stickers

Many Sizes Available!

Available!



Simpson Carbide Drill Bits *Many Options and Sizes Available!*

BH-7064Q-12-21 (Drilling Depth 16" / 3/4" dia.) **SDS Max Quad Head Bit**

BH-7065Q-12-23 (Drilling Depth 18" / 3/4" dia.) **Spline Shank Quad Head Bit**

BH-7065Q-12-16 (Drilling Depth 11" / 3/4" dia.) **Spline Shank Quad Head Bit**

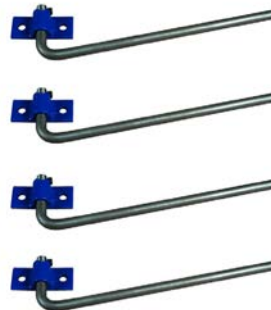

Wheel / Tire Hanger Kits

Increase Efficiency • For Any Budget



SF-92100
Set of 2

BH-7545-70K-4 Kit of 4
BH-7545-70K Individual
Includes Hardware



Wedge Anchors
Many Sizes Available!
BH-7075-03
3/4" x 5-1/2"

Ask How to Get
Free Shipping on
Wedge Anchors!



Screw Anchors
Many Sizes Available!
BH-7075-26
1/2" x 4"
BH-7075-37
3/4" x 5"



Rod Seal Install Tool Set
BH-7079-01
Includes 3 Install Tools
to Service 3/4" ID Seals
up to 3" ID Seals



Inspection
Stickers
Roll of 250
BH-7011-11

ASK FOR OUR INSTALLATION SUPPLIES CATALOG

Air / Hydraulic Pumps for Rolling Bridge Jacks

Options Available—Call Today!



Auto Lift Power Units and Parts

Call SVI today!



Vehicle Lifts and Lifting Equipment

New Lifts for Cars, Trucks, Buses, Motorcycles, UTVs and More

Replacement Cylinders Sections & Kits • Turf Trays for 2-Post Lifts



SVI's Product Line is Vast

CONTACT US TODAY IF THERE'S SOMETHING YOU CAN'T FIND

800-321-8173 • 815-748-0200 • www.sviinternational.com

INCREASE EFFICIENCY • ELIMINATE COSTLY DAMAGE TO DOORS • REDUCE STRESS OF SHOP TECHNICIANS

doorjammer **PRO**™
Durable • Impact Resistant

A Must-Have for All 2-Post Lifts!

Available in 2 Sizes!

BH-7077-02-2S 12" tall x 18" wide

BH-7077-02-2 24" tall x 18" wide

Prevents Door Dings!
Just one damaged door can cost
3 times as much as a simple investment
in one SVI doorjammerPRO™.



Patent Protected

Tire Changer Parts and Accessories

For Most Makes and Models

See our *Tire Changer Repair Parts Catalog!*



Brake Lathe Repair Parts

For Most Makes and Models

See our *Brake Lathe Repair Parts Catalog!*



Hose Reel Hose Stops

Options Available—Call Today!



Alignment Turnplates and Parts



Auto Lift Cables and Chain Sheaves / Pulleys / Chain Rollers



TURF AND UTILITY TRAYS

FOR 2-POST LIFTS
SYMMETRIC / ASYMMETRIC

*The #1 Choice for
Symmetric or Asymmetric
2-Post Surface Mount Lifts
and In-Ground
Side-By-Side, too!*

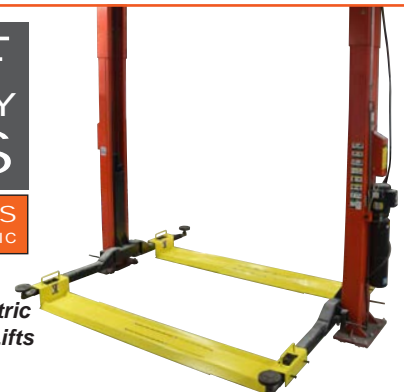

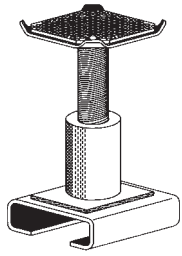

Auto Lift Arm Adapters, Height Extensions, Rubber Pads, Saddles and Adapters

DIRECTFIT™

OPTIONS AVAILABLE FOR ANY MAKE OR MODEL
ABOVE-GROUND LIFT • IN-GROUND LIFT



- 1 Identify Your Lift Adapter Type and Size. View either by size or type. Confirm Dimensions.
- 2 Contact SVI to Order! 800-321-8173 | www.sviinternational.com | parts@sviintl.com

Important: Please note that some adapters are made-to-order and may have minimum order quantity. Please contact us today for pricing!

SVI provides the largest selection of height extensions available to the auto lift industry. In fact, there are over 700 different variations available so you can easily help your customers properly meet their application requirements. Use this catalog to determine available adapters based on lift model. SVI provides a quick turnaround custom-made extension program. When your customers need the proper extension or help with a special extension need—SVI is your answer!

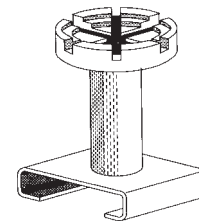

Standard Styles

- Slip-on Fixed
- Slip-on Adjustable
- Drop-on
- Drop-in
- Nesting

Hundreds in stock right now!

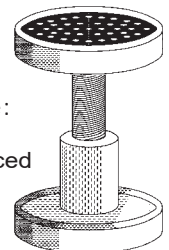
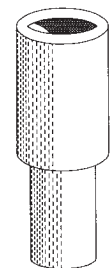
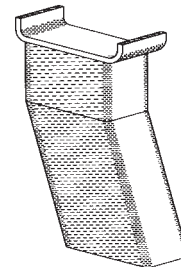

Important Note:
All SVI extensions are engineered and produced to the proper intended design criteria.

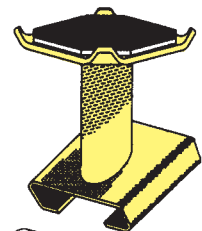
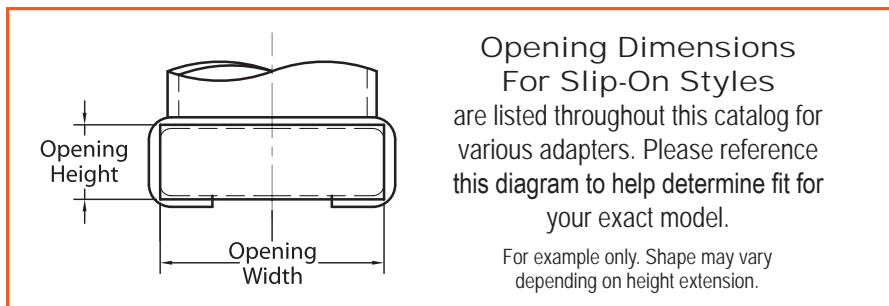

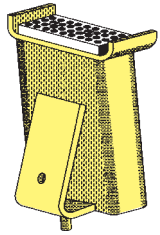

Auto Lift Arm Adapters, Height Extensions, Rubber Pads, Saddles and Adapters

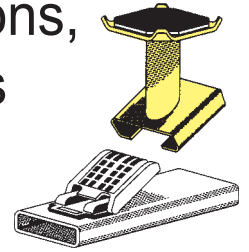

DIRECTFIT™

OPTIONS AVAILABLE FOR ANY MAKE OR MODEL
ABOVE-GROUND LIFT • IN-GROUND LIFT

Contact SVI to Order Height Extensions / Adapters for both Above Ground and In-Ground Lifts!

Standard and Custom Options Available!

800-321-8173 | www.sviinternational.com | parts@sviintl.com

Important: Please note that some adapters are made-to-order and may have minimum order quantity. Please contact us today for pricing!



More, more, more...

- ➔ SVI will meet or beat anyone's advertised price or special. This means you will always be getting the best value for your customer.
- ➔ From Alamo to Western, American to Worth and Rotary to Wheeltronic, SVI has the right extension.
- ➔ Custom application design available. When your customer needs that special extension to properly get to the right lifting point we can help. Contact your favorite SVI representative to get the ball rolling.
- ➔ Ultra competitive blanket order pricing is available. This means you can place one large order for the most popular extension you sell and release shipments as needed. This allows you reduce your cost and boost your profits.
- ➔ SVI pricing programs are available for more than just height extensions. Work closely with SVI on other popular lift parts you may be getting elsewhere. Special pricing programs can be put in place to help you increase your profits and our growing product selection.



**Saddles and Adapters
Contact SVI Today!**



In addition to Standard Adapters, SVI offers: Custom Adapters for In-Ground Lifts!

Put SVI's engineering expertise to work for your customers so everyone can rest assured that their SVI-made special adapters are right for the job. Bring us your custom adapter requirements and for no extra charge, SVI engineers will design the proper strength that you need.

SVI can tailor make adapters for most makes and models of lifts found in the field. We enjoy the aspect of problem solving and using our knowledge and creativity to come up with solutions that fit.

HERE ARE JUST A FEW EXAMPLES:



CUSTOM SADDLE FOR RV MANUFACTURER

This saddle was designed by SVI engineers to meet the needs of an RV manufacturer whose chassis had changed. It fits on a model AC-1010 lift that was produced by Western Hoist. This saddle and adapter Kit provides extended reach capability and quick position pad style adapters.

CUSTOM SLIDING SADDLE ASSEMBLY

This custom sliding saddle assembly was designed to fit a fleet of trucks with a longer wheelbase. SVI's engineering team solved the problem so the trucks were able to be lifted properly for service. The sliding saddle assembly was designed so the lift's capacity would not need to be downrated and the customer was able to reuse their existing adapters.

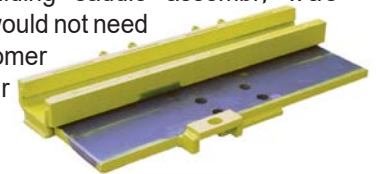

Fits Rotary AT70 Models

Can be made to fit other makes and models.

BH-9755-55A are custom designed rear adapters that have become a standard in the SVI product line. The adapters are for use on Rotary fore and aft bus and truck lifts. The 17" height provides more clearance around the differential.



MODIFIED SADDLE WITH SPECIAL ADAPTERS

A valued distributor in Indiana needed help with a special application that presented itself. The standard saddle and adapter combination that was originally supplied on their customers Rotary lift did not properly reach the lifting points to accommodate some newly purchased vehicles. This meant they were having difficulty in properly and safely lifting the new wider wheelbase vehicles and something needed to be done. SVI was the first and most logical choice to handle such a request.

After listening to the scope of the job and the exact requirements, SVI went immediately to work. The customer needed a modified saddle with special adapters for an older Rotary lift model AT70E that would provide 70" of reach yet still allow for continued use of the standard adapters that were originally supplied. SVI was able to do it all and even upgrade the strength of the saddle at the same time. When fast turn around and special requirements go hand in hand,

SVI is your answer!



BH-9667-20TS is for use in saddles found on the rear section of 10-5/8" and 12-5/8" Weaver and SVI heavy duty lift models. This adapter is made special to provide more clearance between the saddle and the differential housing on some newer model trucks. The 20TS is a 3" taller version than its cousin the -20 and is constructed with a full 3/4" thick riser plate.

CUSTOM HEAVY DUTY ADAPTERS

As new models of trucks and buses are introduced by the manufacturers, existing heavy duty lift adapters don't always match up with newly designed undercarriages. The adapters pictured (right) are a variation of a Rotary design, but made both taller than standard and intended to fit a Weaver saddle. These adapters properly solved clearance issues the shop was encountering. The adapter pictured left was built for a municipal garage that purchased a Sterling tandem axle truck that would be used in the winter to plow and spread salt. This adapter allows the shop to lift the Sterling truck safely between the tandem axles rather than just by one of the two axles. It was also designed to still function as axle engaging for their other single axle vehicles. This adapter solved the problem and handles all of their vehicles so adapter switches never need to be made.

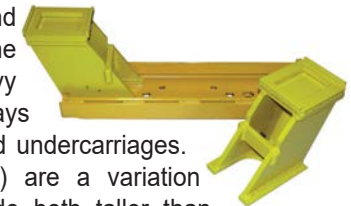

Rubber Pad Adapter For Globe In-Ground BH-9420-29



Auto Lift Pads Quick Reference | DIRECTFIT™ Brand **DIRECTFIT™**

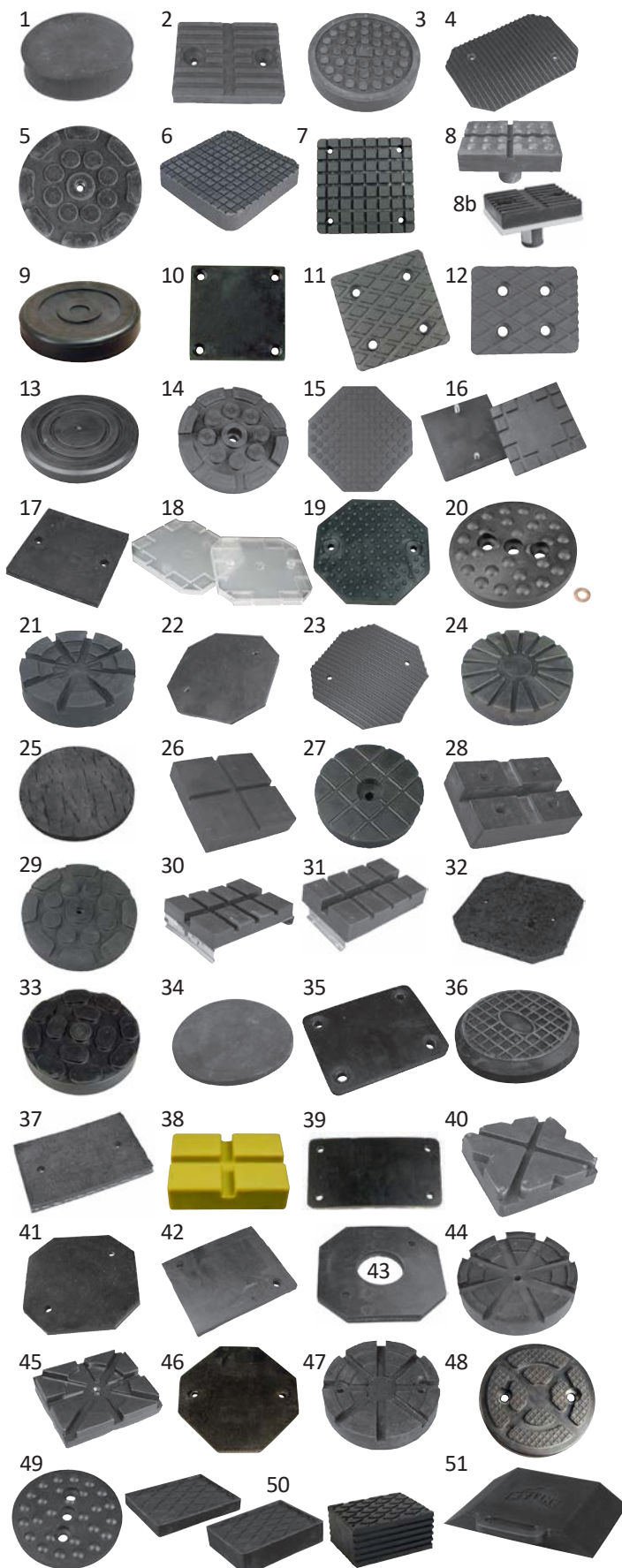

SVI Part #	For OEM Models	Also, ask about:
1 BH-7145-34	Acanus/Ashawa	
2 BH-7101-00	Ammco** & Some Challenger	BH-7101-00-4 (Kit)
3 BH-7150-02	ALM	
4 BH-7165-02	Alamo ASSSA	
5 BH-7588-465	Atlas, Peak, Others	
6 BH-7479-55	BendPak	
7 BH-7256-20P	BendPak, Dannmar, Globe GV	BH-7256-20-KIT (Kit)
8 BH-7475-01	BendPak & Some Western	
8b BH-7475-01R	BendPak & Some Western	BH-7475-01-4 (Kit)
9 BH-7474-78	BendPak / Dannmar	
10 BH-7479-329	BendPak (Fabric Re-inforced)	
11 BH-7214-02	Benwil	
12 BH-7205	Benwil & Bishamon	BH-7205-4 (Kit)
13 BH-7232-93	Challenger / Quality / Launch	(Rubber)
BH-7232-93F	Challenger / Quality Lift / Launch (Fabric Re-inforced)	
14 BH-7232-94	Challenger / Quality Lift	
15 BH-7225-01	Challenger/VBM	BH-7225-01-4 (Kit)
BH-7225-01X	Challenger/VBM (Heavy Duty)	BH-7225-01K (Kit)
16 BH-7232-01	Challenger	BH-7232-01-4 (Kit)
17 BH-7232-01HD	Challenger (Heavy Duty)	BH-7232-01HD-4 (Kit)
18 BH-7232-01U	Challenger (Urethane Snap-In)	
19 BH-7270-048	Direct Lift, Tuxedo	
20 BH-7270-006	Direct Lift	
21 BH-7240-02	Force	
22 BH-7235-90AX	Forward	BH-7235-90K (Kit)
23 BH-7235-90A	Forward / Raptor, Texas Lifts	BH-7235-90 (Kit)
24 BH-7243-01	Fuchs - Zippo	
25 BH-7250-02T	Globe / Ford Smith	
26 BH-7250-03P	Globe / Ford Smith	
27 BH-7250-02	Globe / Ford Smith	
28 BH-7250-01	Globe, Direct Lift, BendPak	
29 BH-7276-00	Hofmann	
30 BH-7350-00	Manitowoc Lifts / Gilbarco	
31 BH-7352-03	Manitowoc Lifts / Gilbarco	
32 BH-7435-07	PMW, Kwik-Way	
33 BH-7586-02	Ravaglioli	
34 BH-7515-73	Rotary Lift	
35 BH-7536-92P	Rotary Lift	BH-7542-73 (Kit)
36 BH-7542-66P	Rotary Lift	BH-7542-66PK (Kit)
37 BH-9755-50-1	Rotary Lift	
38 BH-7508-61	Rotary Lift	
39 BH-7542-75P	SVI (GMT Style Adapters)	BH-7542-75P-4 (Kit)
40 BH-7750-02	Western, Grand, Worth, American	
41 BH-7771-32	Western	BH-7771-32-4 (Kit)
42 BH-7771-51P	Western	
43 BH-7771-32H	Western	
44 BH-7793-54	Wheeltronic	
45 BH-7805-168	Wheeltronic	BH-7805-168-4 (Kit)
46 BH-7820-04	Whip	
The following pads fit a variety of models:		
47 BH-7450-02	For Nussbaum, Force, and HydraLift	BH-7450-02-4 (Kit)
48 BH-7588-463	For Twin Busch, Peak, Launch	
49 BH-7560-04	For Powerrex, Complete Hydraulics, Globe, Direct Lift (This 3-hole pad is universal to replace previous styles with 1-2 holes)	
50 BH-9756-86T	Stack Pad 6.25" x 4.75" x 1/2" Tall	
-- BH-9756-86	Stack Pad 6.25" x 4.75" x 1-1/2" Tall	
-- BH-9756-87	Stack Pad 6.25" x 4.75" x 3" Tall	
51 SC-8150-25	Riser Pad 18" x 12" x 2.5" Tall	

For more details on rubber pads and height extensions, see our catalog or call!

www.sviinternational.com

LRC7090 - 2.27.24



Auto Lift Pads Quick Reference | DIRECTFIT™ Brand **DIRECTFIT™**

UNIVERSAL | FOR MANY MAKES & MODELS
Rubber Adapter Blocks (Stack Pads) • 4-3/4" x 6-1/4"
 BH-9756-86T (Ref SB700071Y) 1/2" Thick
 BH-9756-86 (Ref FJ2427) 1-1/2" Thick
 BH-9756-87 (Ref FJ2428x) 3" Thick

1/2" Thick BH-9756-86T
 1-1/2" Thick BH-9756-86
 3" Thick BH-9756-87

UNIVERSAL | FOR SPORT CARS!
FOR LOW PROFILE VEHICLE APPLICATIONS
Rubber Riser Pad
 SC-8150-25 1 Pad

Use SVI's Rubber Riser Pads to raise low-profile cars up higher from the floor for easier placement of 2-post swing arms

Features Handle for Easy Placement

2-1/2" Tall

SPECIALTY | FOR SVI'S GMT STYLE ADAPTERS
Rectangle Rubber Arm Pad for SVI's GMT Style Specialty Wide Adapters for 2019, 2020 and newer Chevrolet 1500 Silverado and GM Sierra Trucks
These Adapters Feature 7" Wide Lifting Area— Available For Many Makes and Models

BH-7542-75P 1 Pad Only
 BH-7542-75P-4 Kit of 4 Pads with Fasteners

TYPE GMT

6" x 3.25" x 3/8" Thick

Whether it's standard or custom, SVI is your answer.
 Don't see what you need?
 Contact SVI today!
 800-321-8173
 parts@svintl.com

Insist on SVI Direct Fit™ brand Products!

FOR ACANUS / ASHAWA
Rubber Lift Pad - Round
 BH-7145-34
 (Ref SP12-JB-016)

4.44"
 1.0"

FOR AMMCO, BEN PEARSON, CHALLENGER LIFTS, TUXEDO, AND MANY
Rectangle Rubber Arm Pad
 (Replaces Ref 82365, 10-0017, 482365, 91559, 37008, others)
 BH-7101-00 • 1 Pad
 BH-7101-00-4 • Kit of 4 Pads

3-7/8"
 3-1/4"
 4-7/8"
 3/8"
 1/8"
 7/8"

FOR ALM
 BH-7150-02 (Ref A94208)
Rubber Lift Pad (1) - Round
Sold individually

6-5/16" OD
 Bottom Dimensions: 5-7/8" ID with Lip

FOR ALAMO ASSSA
 BH-7165-02
Rubber Lift Pad

5.750
 3.750
 #312 2 HOLES

FOR ATLAS, PEAK, MORE
Rubber Lift Pad - Round
 (Ref 209134, ATPKP-LP-CIR)
 BH-7588-465 1 Pad

0.83" Thick

Please Confirm Dimensions 4-3/4" OD 9/32" Center Hole

FOR BENDPAK
Slip Over Square Pad for BendPak (Ref 5715365, 119456)
 BH-7479-55 (1) Individual Pad

5 5/8 SQUARE
 1 1/16

P
a
g
e

Auto Lift Pads Quick Reference | DIRECTFIT™ Brand **DIRECTFIT™**

FOR BENDPAK, DANNMAR, GLOBE (GV)

4-3/4" Square Bolt On Pad for BendPak
(Ref 5715017, 17108189)

BH-7256-20P (1) Individual Pad

BH-7256-20-KIT Kit of 4 Pads and Fasteners



4-3/4" x
4-3/4" Square

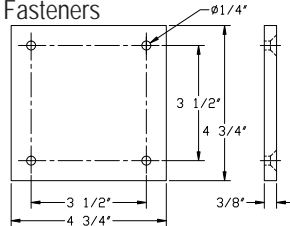

FOR BENDPAK AND SOME WESTERN

(Ref 5170105)

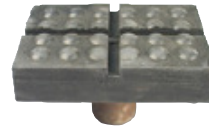

◀ If you had this old rubber molded-on steel style, now order # BH-7475-01R.

Arm Pad Adapter with Replaceable Pad with 1-3/8" (35 mm) Pin Dia. (Ref 5170105x)

BH-7475-01R Adapter and Pad

BH-7101-00 Replacement Rubber Pad Only

BH-7475-01-4 Replacement Rubber Pad Kit of 4 Rubber Pads & Fasteners for 7475-01R



Type NSP

FOR BENDPAK AND DANNMAR

Round Slip Over Pad for BendPak
(Ref 5715017, 17108252)

BH-7474-78 (1) Individual Pad



5" OD
Bottom Side:
4-3/8" ID with Lip



FOR BENDPAK

3" Square Bolt On Pad
(Ref 5715016, 5174006P)

BH-7479-329 (1) Pad Only

For XPR-18C and others



3" x 3" Square

FOR BENDPAK

4" Square Bolt On Pad for XPR-10, others

BH-7479-335 (1) Pad Only

4" x 4" Square

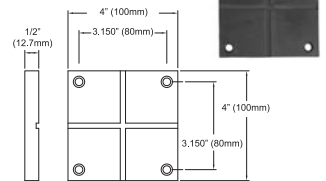

FOR BENWIL, BISHAMON, AND MANY ADAPTERS

Rubber Arm Pads (Ref 100533)

BH-7205 Individual Arm Pad

BH-7205-4 Kit of 4 Pads and Fasteners

SVI includes both US and Metric Fasteners.

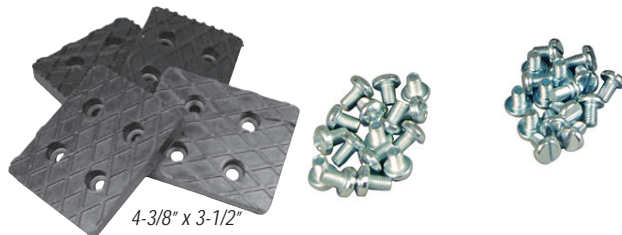

4-3/8" x 3-1/2"

Note: This pad is molded around a steel insert for stay put attachment to the lift arm.



Cross-section showing steel insert.

FOR BENWIL

Rubber Arm Pad (Square)
(Ref 50509901, 50606151)

BH-7214-02 Individual Pad (1)



3-9/16" Square
2" Hole Centers



Auto Lift Pads Quick Reference | DIRECTFIT™ Brand **DIRECTFIT™**

FOR CHALLENGER, AMMCO, LAUNCH, OTHERS

Octagon Heavy Duty Rubber Pad vs. Urethane Pad

An SVI Exclusive

for Challenger CL-10 and many others

SVI is offering this Heavy-Duty Rubber Pad as an alternative to the Urethane Snap-In Pad (Ref A1104-H) that you have been ordering. The issue we've found with the Urethane Pad is called "compression set". With the weight of the vehicle pressing down on the urethane pad, it is pancaking or compressing the pad outward. The urethane does not rebound well and takes a compression set. As the urethane pad gets wider and wider against the two solid sides it is rejected from expanding horizontal and subsequently bows upward causing the undesirable outcome and appearance. This new Heavy-Duty Rubber Arm Pad is the better choice for your application.



Heavy Duty Bolt-On Style Rubber Arm Pad

Each pad is produced from a special 3/8" thick 2-ply durable reinforced material to increase service life.



An example of a "compression set" urethane pad on Challenger Lift



Urethane Snap-In Style

FOR CHALLENGER, AMMCO, LAUNCH, OTHERS

Snap-In Urethane Pad (Ref A1104-H, A1104H)

BH-7232-01U 1 Pad — Sold individually



3-27/32" x 3-15/16"
2 Snap-In Pegs On Bottom

Heavy Duty Bolt-On Rubber Arm Pad An SVI Exclusive

BH-7232-01OHD 1 Pad

BH-7232-01OHD-4 Set of 4 Pads

The Better Choice! Does Not Curl Up Like Urethane!

An Alternative to Snap-In Urethane Pad (Ref A1104-H, A1104H)



3/8" Thick 2-Ply

Replace your snap-in urethane pads with SVI's Bolt-On Rubber Pad Alternative—The Better Choice!

THIS ADAPTER WITH URETHANE SNAP-IN PAD IS COMMON ON CHALLENGER, AMMCO, LAUNCH, MAGNUM, QUALITY LIFTS, AND OTHERS

BH-7232-01UPB (Ref B2270)

Drop-In Adapter / Foot Pad Assembly with Urethane Pad

Works well with BH-7234-119 (ref 10315) Height Extension Kit

Replacement Pad: BH-7232-01U (Ref A1104H, Urethane) or BH-7232-01OHD (Rubber)

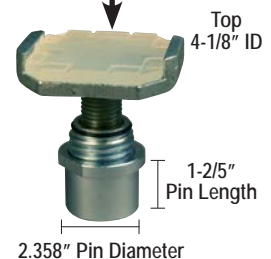

Auto Lift Pads Quick Reference | DIRECTFIT™ Brand **DIRECTFIT™**

FOR CHALLENGER / VBM AND MANY ADAPTERS
Standard Octagon Rubber Arm Pad



BH-7225-01
 Octagon Rubber Arm Pad (1)

BH-7225-01-4
 Rubber Arm Pad Kit for 1 Lift
 (Includes 4 pads and hardware)

Also see Heavy Duty Version.

FOR CHALLENGER / VBM AND MANY ADAPTERS
Heavy Duty Octagon Rubber Arm Pad



BH-7225-01X
 HD Rubber Arm Pad (1)

BH-7225-01K
 HD Pad Kit for 1 Lift
 (Includes 4 pads and hardware)

BH-7225-01KL
 HD Pad Kit for 1 Lift
 with Long Bolts
 (Includes 4 pads and hardware)

FOR CHALLENGER AND QUALITY LIFTS

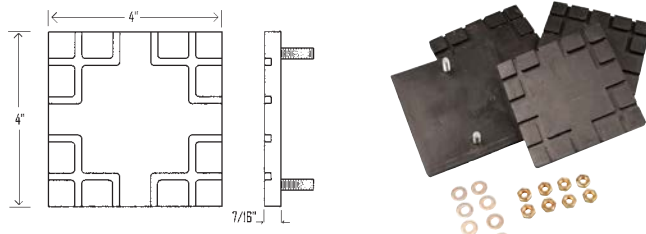

Square Rubber Pad for CL10, VS10, others

BH-7232-01 (Ref A1104, B1104) 1 Pad
BH-7232-01-4 (Ref A11052) Kit of 4 Pads with Fasteners

FOR CHALLENGER AND QUALITY LIFTS



Heavy Duty Square Rubber Pad for CL10, VS10, others

BH-7232-01HD (Ref A1104x, B1104x) 1 Pad
BH-7232-01HD-4 (Ref A11052x) Kit of 4 Pads with Fasteners

FOR CHALLENGER, QUALITY, AND LAUNCH
Round Rubber Pads for CL10, VS10, others
 (Ref B2208, 104130315, VS10-31-03)

Sold Individually



BH-7232-93 Standard (1 Pad)
BH-7232-93F Fabric Reinforced (1 Pad)

5-7/16" OD **Fabric Reinforced**

FOR CHALLENGER, AMMCO, LAUNCH, OTHERS
Specialty Urethane Snap-In Pad for OEM Version of Adapter for 2019, 2020 and newer Chevrolet 1500 Silverado and GM Sierra Trucks



BH-7232-98GMAP (Ref B2280-01) Replacement Pad (1)

Specialty Wide Style Snap-In Pad for OEM Version Adapter for 2019, 2020, and Newer GM/Chevy Trucks

Approximately 6" x 3-1/2"

FOR CHALLENGER & QUALITY LIFTS
Round Rubber Arm Pad with Center Bolt Hole
 (Ref 26K25030)

BH-7232-94 1 Pad Only

Sold Individually



4-3/4" OD
 1" Thick

FOR DANNMAR AND BENDPAK
Round Slip Over Pad for Danmar / BendPak
 (Ref 17108252, 5715017)

BH-7474-78 (1) Individual Pad



5" OD
 Bottom Side:
 4-3/8" ID with Lip



FOR DANNMAR
4-3/4" Square Bolt On Pad for Danmar (Ref 17108189)

BH-7256-20P (1) Pad Only
BH-7256-20-KIT Kit of 4 Pads and Fasteners



4-3/4" x 4-3/4" Square
 3/8" Thick



Auto Lift Pads Quick Reference | DIRECTFIT™ Brand **DIRECTFIT™**

FOR DIRECT LIFTS AND OTHERS
1/2" Thick Round Rubber Arm Pad with Washer
 (Ref PV-6003)

BH-7270-006 1 Pad



Note: This Pad is Used For Both 1-Hole and 2-Hole Applications

4-11/16" OD
3 Holes

FOR DIRECT LIFTS
Rectangle Rubber Pad
 (Ref PMR-6131)
 BH-7250-01 Individual Pad

Note: This pad is molded around a steel insert for stay put attachment to the lift arm.



1-1/8" Thick
4-9/16" x 3-1/8"

FOR DIRECT & TUXEDO
5" Octagon Rubber Pad
 (Ref 52200-3)
 BH-7270-048 Individual Pad
Sold individually



1/2" Thick Pad
Holes are 3.6" Apart

FOR FORCE
Slip-On Round Rubber Arm Pad
 (Ref 90292)
 BH-7240-02 (1) Pad Only
 Sold Individually



4-9/16" OD
4" ID
Bottom Side with lip

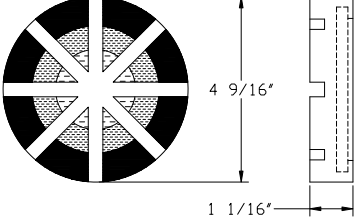

Also see BH-7450-02 for Nussbaum



Whether it's standard or custom, SVI is your answer.
 Don't see what you need?
 Contact SVI today!
 800-321-8173
 parts@sviintl.com

Insist on SVI Direct Fit™ brand Products!

FOR FORWARD LIFTS, RAPTOR, TEXAS LIFTS, AND MANY OTHERS
Octagon Rubber Arm Pad Standard Version (Ref 994105, 991234, 991222, 91062, others)
 BH-7235-90A 1 Pad
 BH-7235-90 Kit of 4 Pads and Hardware



Octagon Rubber Arm Pad Heavy Duty Version
 BH-7235-90AX 1 Pad
 BH-7235-90K Kit of 4 Pads

**Thicker with Fabric Reinforcement—
 The Better Choice!**

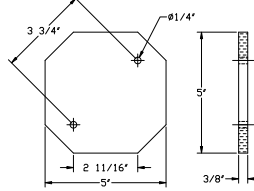
FOR FUCHS / ZIPPO
6" Round Rubber Slip-Over Arm Pad
Bottom Side Inside Dimension 5.812"
 BH-7243-01 (1) Pad





Auto Lift Pads Quick Reference | DIRECTFIT™ Brand **DIRECTFIT™**

<p>FOR GLOBE / FORD SMITH 4" Round Adhesive-Style Pad (Ref 203822, FS-203822) BH-7250-02T 1 Pad</p>	<p>FOR GLOBE / FORD SMITH Round Bolt-On Rubber Pad (Ref 203047, FS-203047) BH-7250-02 1 Pad</p> <p>Pad Diameter: 4-17/32" 13/16" Thick Thru Hole: .390" Dia.</p> <p><i>Hardware Not Included</i></p>	<p>FOR GLOBE / FORD SMITH Slip-Over Square Rubber Pad (Ref 208512, FS-208512) BH-7250-03P 1 Pad</p> <p>4-1/2" x 4-1/2" 1" Thick</p>	<p>FOR GLOBE GV SERIES 4-3/4" Square Bolt On Pad BH-7256-20P (1) Individual Pad BH-7256-20-KIT Kit of 4 Pads and Fasteners 4-3/4" x 4-3/4" Square</p>
<p>FOR GLOBE LIFTS, FORD SMITH, BENDPAK, AND BENWIL Rectangle Rubber Insert (Ref DG 3032700 01, PMR-6131, 400106-5-2, 400106-5-13) BH-7250-01 Individual Pad</p> <p>1-1/8" Thick 4-9/16" x 3-1/8"</p> <p>Note: This pad is molded around a steel insert for stay put attachment to the lift arm.</p> <p><i>Hardware Not Included</i></p>	<p>FOR HOFMANN Bolt-On Round Rubber Pad (Ref 1701-261) BH-7276-00 1 Pad</p> <p>4-5/8" Round</p>	<p>FORMANITOWOCLIFTS, GILBARCO LIFTS Rubber Arm Pad (Ref K93223) BH-7350-00 1 Arm Pad</p> <p>Please confirm dimensions</p>	<p>FOR P.M.W., KWIKWAY, LINE-O-TRONICS (L.O.T) Rubber Arm Pad (Ref 141001, 315-1410-01) BH-7435-07 1 Arm Pad</p>
<p>FORMANITOWOCLIFTS, GILBARCO LIFTS Rubber Arm Pad (Ref K34314) BH-7352-03 1 Arm Pad</p> <p>Please confirm dimensions</p>	<p>FOR NUSSBAUM, FORCE, HYDRA-LIFT 4-15/16" Bolt-On Round Rubber Arm Pad (Ref 10.157, 28335) BH-7450-02 (1) Pad Only BH-7450-02-4 Set of 4 Pads with Fasteners</p> <p>4-25/32" ID Bottom Side</p>	<p>FOR POWERREX, COMPLETE HYDRAULICS, GLOBE 4-11/16" Diameter Pad (Ref SL3, SL4) This Universal Pad has 3 Holes because is used for both 1-Hole and 2-Hole Applications BH-7560-04 1 Pad Sold Individually</p> <p>Previously BH-7560-11</p>	<p>FOR QUALITY & CHALLENGER LIFTS Round Rubber Arm Pad with Center Bolt Hole (Ref 26K25030) BH-7232-94 1 Pad Only Sold Individually</p> <p>4-3/4" OD 1" Thick</p>
<p>FOR RAVAGLIOLI 100mm Slide On Round Rubber Pad (Ref 047021850) BH-7586-02 1 Pad</p> <p>Please confirm dimensions</p> <p>Pad Diameter: 100mm (4") Bottom Side: 3-3/8" ID with Lip</p>			

P
a
g
e



Auto Lift Pads Quick Reference | DIRECTFIT™ Brand **DIRECTFIT™**

FOR ROTARY LIFTS
 BH-7536-92P (Ref FJ6158-4) Rubber Pad (1)
 BH-7542-73 (Ref FJ6213) Rubber Pad Kit of 4 Pads and Fasteners

FOR ROTARY LIFTS
Round Slip-Over and Screw-On Waffle Style Rubber Pad
 Replaces Old Style. (Ref FJ6202-3, FJ5174)
 BH-7542-66P 1 Pad
 BH-7542-66PK Kit of 4 Pads and Fasteners

FOR ROTARY LIFTS
Round Rubber Pad
 (Ref FJ6155-7)
 BH-7515-73 1 Pad

FOR ROTARY LIFTS
Slip-Over Rectangle Yellow Arm Pad (Ref FJ7735-2)
 BH-7508-61 1 Pad

Insist on SVI Direct Fit™ brand Products!

FOR ROTARY LIFTS AND OTHERS
Rectangle Rubber Pad for SORP Style Adapters
 BH-9755-50-1 1 Pad

FOR TWIN BUSCH, PEAK, LAUNCH LIFTS, TLS, AND OTHERS
 (Ref TW G-D12cm, LAUNCH120)
Bolt-On Round Rubber Pad
 BH-7588-463 1 Pad

FOR WESTERN, GRAND, AND WORTH
X-Pattern Rectangle Slip-Over Rubber Pad (Ref S-350)
 BH-7750-02 1 Pad
Sold Individually

FOR WESTERN
Bolt-On Rectangle Rubber Pad for SVT-1 (Ref S-2002)
 BH-7771-51P 1 Pad

FOR WESTERN
Bolt-On Octagon Rubber Pad with Center Hole (Before 01-01-2000) (Ref S-2001x)
 BH-7771-32H 1 Pad

Includes Hardware

FOR WESTERN
Bolt-On Octagon Rubber Pad without Hole for Use After Date 01-01-2000 (Ref S-2001)
 BH-7771-32 1 Pad
 BH-7771-32-4 Kit of 4 Pads

Includes Hardware

Auto Lift Pads Quick Reference | DIRECTFIT™ Brand **DIRECTFIT™**

FOR WHEELTRONIC LIFTS AND OTHER LIFTS MADE BY WHEELTRONIC

5" Round Rubber Arm Pad (Ref 6-2050)

BH-7793-54 1 Pad

Sold Individually

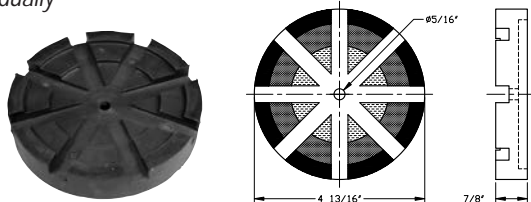

FOR WHEELTRONIC LIFTS AND OTHER LIFTS MADE BY WHEELTRONIC

Rectangle Rubber Arm Pad (Ref 3-0872)

BH-7805-168 1 Pad

BH-7805-168-4 Kit of 4 Pads and Hardware

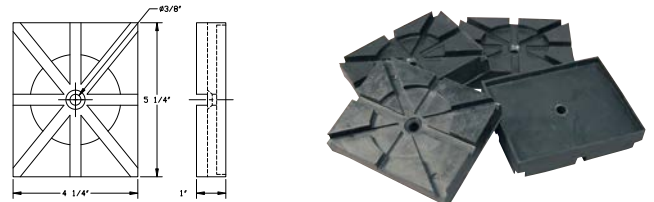

FOR WHIP LIFTS

Octagon Rubber Arm Pad (Ref GL-09-013)

BH-7820-04 1 Pad

Sold Individually



0.38" Thick

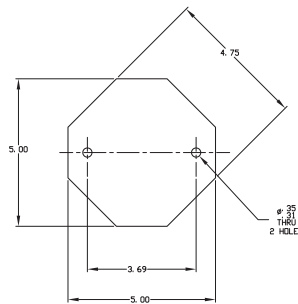

FOR NRW-STYLE HEIGHT EXTENSION ADAPTERS

Pad for NRW Extensions

BH-9900-10A 1 Pad

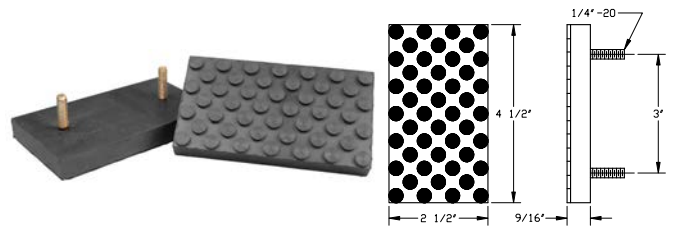

Insist on SVI Direct Fit™ brand Products!

Whether it's standard or custom, SVI is your answer.

Don't see what you need?
Contact SVI today!
800-321-8173
parts@sviintl.com

FOR ZIPPO / FUCHS

6" Round Rubber Slip-Over Arm Pad

Bottom Side Inside Dimension 5.812"

BH-7243-01 (1) Pad

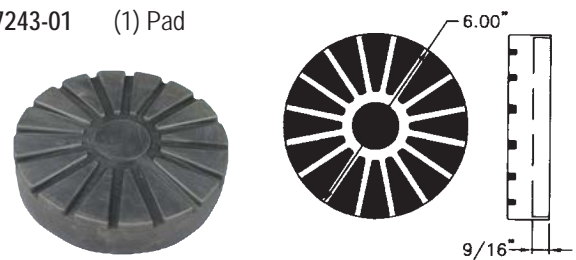



Auto Lift Pads Quick Reference | DIRECTFIT™ Brand **DIRECTFIT™**

FEATURED—SPECIALTY

Jack / Lifting Pads for Tesla Models 3, S, X

One-piece, fully insulated pad that will not damage paint.

SVI's Jack / Lifting Pads for Tesla Models 3, S and X are designed to fit snugly into and hang from the jack points for easy alignment when using floor jacks and professional car lifts. Our jack pad tool is the most popular selling jack pad adapter for Tesla 3, S and X. The simple round design assures that the pad will be inserted into the jack point correctly, whereas, rectangular shaped tools can be inadvertently inserted with the incorrect orientation.

Keep a set of these on hand to be sure your local tire and repair shop properly lifts your vehicle without damaging your battery or under carriage.

Also available as a set of 4 in a plastic storage tube. **SVI is your answer!**



ADAPTERS ARE STAMPED WITH TESLA MODEL NUMBER

SVI Part #	For:	Description
SC-8701-01	Tesla	Jack / Lifting Pad Tesla Model 3
SC-8701-01K	Tesla	Jack / Lifting Pad Kit (4) Tesla Model 3
SC-8701-02	Tesla	Jack / Lifting Pad Tesla Model X or S
SC-8701-02K	Tesla	Jack / Lifting Pad Kit (4) Tesla Model X or S

Height Extensions and Adapters By Type / Style

Please always confirm dimensions before ordering. Height Extensions and Adapters come in many different styles and dimensions. SVI is well-known as the adapter expert, specializing in top quality standard and custom adapters. SVI is your answer.

For Many Makes and Models—Outer Arm Adapters

Outer Arm Adapter with Rubber Pad for Any Lift
 BH-7090-97 • For 3-1/2" Wide Arm
 BH-7090-94 • For 4" Wide Arm
 BH-7090-98 • For 4-3/4" Wide Arm
 BH-7090-95 • For 5" Wide Arm
 BH-7090-96 • For 6" Wide Arm

Works well with Toyota GR Supra and Low-Profile Cars

Replacement Pad: BH-7101-00

Specify Outer Arm Width

Specify Arm Width

Rectangle Rubber Arm Pad
 (Ref 82365, others)
 BH-7101-00 1 Pad Only
 BH-7101-00-4 Kit of 4 Pads and Hardware

3-7/8" x 4-7/8" x 7/8"

For Many Makes and Models—Adapters for Low Rise / Mid Rise

Rubber Adapter Blocks (Stack Pads) • 4-3/4" x 6-1/4"

BH-9756-86T (Ref SB700071Y)	1/2" Thick
BH-9756-86 (Ref FJ2427)	1-1/2" Thick
BH-9756-87 (Ref FJ2428x)	3" Thick

1/2" Thick BH-9756-86T 1-1/2" Thick BH-9756-86 3" Thick BH-9756-87

LRPS FIXED Height
 Height Extension - Specialty Double Sided
 Features (2) Replaceable Octagon Rubber Pads BH-7225-01

BH-7091-01 • 3" Adapter	<p>Type LRPS</p>
BH-7091-02 • 4" Adapter	
BH-7091-03 • 5" Adapter	
BH-7091-04 • 6" Adapter	
BH-7091-05 • 7" Adapter	

Adjustable Height Extension Specialty Double Sided
 Features Replaceable Octagon Rubber Pads (2) BH-7225-01

BH-7091-06 • 4" to 6" Adj.	<p>Type ALRPS</p>
BH-7091-07 • 5" to 8" Adj.	

ALRPS
 ADJUSTABLE Height

Rubber Arm Pad - Octagon
 (Ref 31057, 200086, 11052)

BH-7225-01	1 Pad Only
BH-7225-01-4	Set of 4 Pads with Fasteners

3/8" Thick 2-Ply

Heavy Duty Style Available

LRPR FIXED Height
 Height Extension - Specialty
 Features (2) Replaceable Round Rubber Pads BH-7150-02

BH-7091-10 • 3" Adapter	<p>Type LRPR</p>
BH-7091-11 • 4" Adapter	
BH-7091-12 • 5" Adapter	
BH-7091-13 • 6" Adapter	
BH-7091-14 • 7" Adapter	

Adjustable Height Extension Specialty Double Sided
 Features Replaceable Round Rubber Pads (2) BH-7150-02

BH-7091-15 • 4" to 6" Adj.	<p>Type ALRPR</p>
BH-7091-16 • 5" to 8" Adj.	

ALRPR
 ADJUSTABLE Height

BH-7150-02 (Ref A94208)
 Rubber Lift Pad (1) - Round
 Sold Individually

6-5/16" OD
 Bottom Dimensions: 5-7/8" ID with Lip



Height Extensions and Adapters By Type / Style

Please always confirm dimensions before ordering. Height Extensions and Adapters come in many different styles and dimensions. SVI is well-known as the adapter expert, specializing in top quality standard and custom adapters. SVI is your answer.

LDH Slip-Over Height Extension Adapter - FIXED Height

For ALM, Ammco®* (New), Benwil, Bishamon, Challenger Lifts, Force, Forward Lifts, Gilbarco, Globe Lifts, Magnum, Manitowoc Lifts, Nussbaum, Phoenix, VBM, Western, Worth, others

Features Octagon Rubber Pad (*Varies per adapter*)



BH-7225-01 Individual Arm Pad
BH-7225-01-4 Kit of 4 Pads and Fasteners

BH-7235-90A Individual Arm Pad
BH-7235-90 Kit of 4 Pads and Fasteners

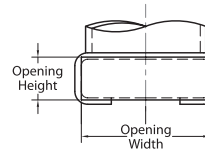

With Octagon Pad

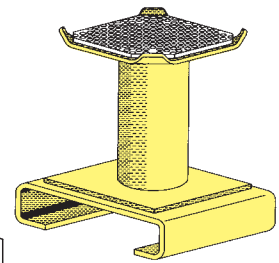

This is a **FIXED STYLE** Height Extension. **See Type ALDH for Adjustable Version.**

FOR ALM LIFTS

Fixed Slip-On Height Extension with Octagon Pad
Fits over BH-7150-02 Round Pad

- BH-7150-34 • 3" Extension
- BH-7150-35 • 4" Extension
- BH-7150-36 • 5" Extension
- BH-7150-01 • 6" Extension
- BH-7150-37 • 7" Extension
- BH-7150-39 • 8" Extension
- BH-7150-40 • 9" Extension
- BH-7150-41 • 10" Extension

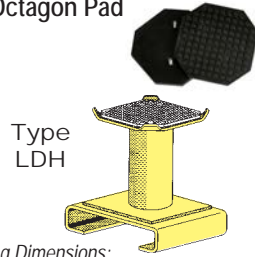

Opening Dimensions:
6-1/2" x 1-5/16"
Replacement Pad: BH-7225-01

FOR CHALLENGER LIFTS, AMMCO®* (NEW) & VBM

Fixed Slip-On Height Extension with Octagon Pad

- BH-7227-23 • 3" Extension
- BH-7227-24 • 4" Extension
- BH-7227-25 • 5" Extension
- BH-7225-02 • 6" Extension
- BH-7227-26 • 7" Extension
- BH-7227-27 • 8" Extension
- BH-7225-05 • 9" Extension
- BH-7227-28 • 10" Extension
- BH-7227-29 • 11" Extension
- BH-7227-30 • 12" Extension

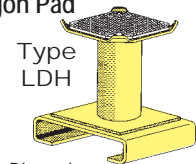

Opening Dimensions:
6-1/8" x 1"

Fits over BH-7225-01 Rubber Pad
Replacement Pad: BH-7225-01

FOR FORWARD LIFTS & VBM (OLD SQUARE)

Fixed Slip-On Height Extension with Octagon Pad
Fits over Spin-Up with Corners Turned Up with BH-7235-90A Pad. VBM Old Square is Flat.

- BH-7236-60 • 3" Extension
- BH-7236-61 • 4" Extension
- BH-7236-62 • 5" Extension
- BH-7235-88 • 6" Extension
- BH-7236-63 • 7" Extension
- BH-7236-64 • 8" Extension
- BH-7236-65 • 9" Extension
- BH-7236-66 • 10" Extension

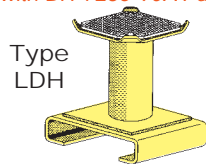

Opening Dimensions:
5-3/4" x 15/16"
Replacement Pad: BH-7235-90A

FOR GILBARCO LIFTS

Fixed Slip-On Height Extension with Octagon Pad
Fits over BH-7350-00 / K93223 Pad

- BH-7353-16 • 3" Extension
- BH-7353-17 • 4" Extension
- BH-7353-18 • 5" Extension
- BH-7353-19 • 6" Extension
- BH-7353-20 • 7" Extension
- BH-7353-21 • 8" Extension
- BH-7353-22 • 9" Extension
- BH-7353-23 • 10" Extension

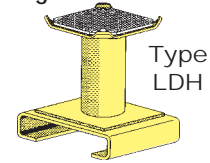

Opening Dimensions:
5-3/16" x 3/4"
Fits over BH-7350-00 / K93223 Pad
Replacement Pad: BH-7235-90A

FOR GLOBE LIFTS & FORD SMITH

Fixed Slip-On Height Extension with Octagon Pad
Fits over BH-7250-01 Rubber Pad

- BH-7250-07 • 6" Extension

Other Heights May Be Available Contact SVI Today.

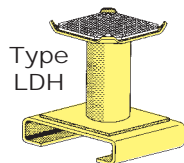

Opening Dimensions:
4-9/16" x 1-3/16"
Replacement Pad: BH-7235-90A

FOR AMERICAN, EAGLE, & GRAND

Fixed Slip-On Height Extension with Octagon Pad
Fits over Spin-Up with four Corners turned up.

- BH-7376-19 • 3" Extension
- BH-7376-20 • 4" Extension
- BH-7376-21 • 5" Extension
- BH-7376-22 • 6" Extension
- BH-7376-23 • 7" Extension
- BH-7376-24 • 8" Extension
- BH-7376-25 • 9" Extension
- BH-7376-26 • 10" Extension

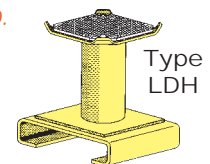

Opening Dimensions:
5-3/16" x 25/32"
Replacement Pad: BH-7235-90A

Height Extensions and Adapters By Type / Style

Please always confirm dimensions before ordering. Height Extensions and Adapters come in many different styles and dimensions. SVI is well-known as the adapter expert, specializing in top quality standard and custom adapters. SVI is your answer.

LDH Slip-Over Height Extension Adapter - FIXED Height Continued

FOR HYDRA-LIFT

Fixed Slip-On Height Extension with Octagon Pad

Fits over Hydra-Lift Adapter without Pad

- BH-7290-26 • 3" Extension
- BH-7290-27 • 4" Extension
- BH-7290-28 • 5" Extension
- BH-7290-29 • 6" Extension
- BH-7290-30 • 7" Extension
- BH-7290-31 • 8" Extension
- BH-7290-32 • 9" Extension
- BH-7290-33 • 10" Extension

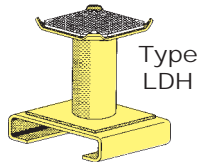

Type LDH

Opening Dimensions:
4-2/3" x 1"

Replacement Pad: BH-7235-90A

FOR HYDRA-LIFT

Fixed Slip-On Height Extension with Octagon Pad

Fits over Spin-Up with Round Rubber Pad BH-7450-02

- BH-7290-34 • 3" Extension
- BH-7290-35 • 4" Extension
- BH-7290-36 • 5" Extension
- BH-7290-37 • 6" Extension
- BH-7290-38 • 7" Extension
- BH-7290-39 • 8" Extension
- BH-7290-40 • 9" Extension
- BH-7290-41 • 10" Extension

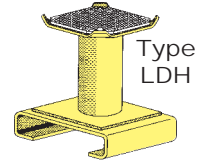

Type LDH

Opening Dimensions:
5-1/8" x 1-5/16"

Replacement Pad: BH-7235-90A

FOR MANITOWOC LIFTS

Fixed Slip-On Height Extension with Octagon Pad

Fits over spin-up with 2 sides turned up with BH-7350-00 / K93223 Pad

- BH-7353-24 • 3" Extension
- BH-7353-25 • 4" Extension
- BH-7353-26 • 5" Extension
- BH-7353-27 • 6" Extension
- BH-7353-28 • 7" Extension
- BH-7353-29 • 8" Extension
- BH-7353-30 • 9" Extension
- BH-7353-31 • 10" Extension
- BH-7353-31L • 11" Extension
- BH-7353-31XL • 12" Extension

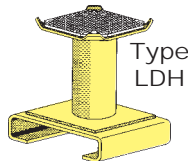

Type LDH

Opening Dimensions: 5-1/4" x 1/2"
Replacement Pad: BH-7235-90A

FOR NUSSBAUM, PHOENIX & FORCE

Fixed Slip-On Height Extension with Octagon Pad

Fits over Spin-Up with Round Pad

- BH-7450-28 • 3" Extension
- BH-7450-29 • 4" Extension
- BH-7450-30 • 5" Extension
- BH-7450-03 • 6" Extension
- BH-7450-32 • 7" Extension
- BH-7450-33 • 8" Extension
- BH-7450-34 • 9" Extension
- BH-7450-35 • 10" Extension

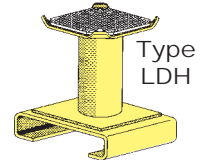

Type LDH

Opening Dimensions:
5-3/8" x 1-1/8"

Replacement Pad: BH-7235-90A

FOR POWERREX LIFTS

Fixed Slip-On Height Extension with Octagon Pad

- BH-7560-01 • 6" Extension

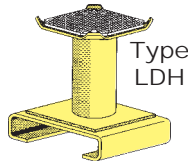

Type LDH

Opening Dimensions: 5-3/16" x 1"
Replacement Pad: BH-7225-01



Height Extensions and Adapters By Type / Style

Please always confirm dimensions before ordering. Height Extensions and Adapters come in many different styles and dimensions. SVI is well-known as the adapter expert, specializing in top quality standard and custom adapters. SVI is your answer.

ALDH Slip-Over Height Extension Adapter - ADJUSTABLE Height

For Alamo, ALM, Ammco®* (New), ASSSA, Benwil, Bishamon, Challenger Lifts, Force, Forward Lifts, Gilbarco, Globe Lifts, Magnum, Manitowoc Lifts, Nussbaum, Phoenix, VBM, Western, others

With Octagon Pad

Features Octagon Rubber Pad (*Varies per adapter*)



BH-7225-01 Individual Arm Pad
BH-7225-01-4 Kit of 4 Pads and Fasteners

BH-7235-90A Individual Arm Pad
BH-7235-90 Kit of 4 Pads and Fasteners

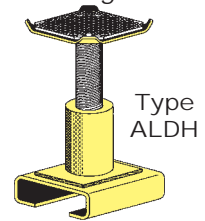
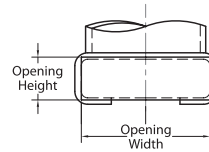

Type ALDH

This is an ADJUSTABLE STYLE Height Extension. See Type ALDH for Adjustable Version.

FOR ALAMO, ASSSA

Adjustable Slip-On Height Extension with Octagon Pad

Fits over BH-7165-02 Pad

BH-7165-10 • 4"-6" Adjustable
BH-7165-11 • 6"-9-1/2" Adjustable

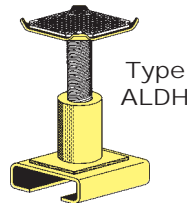

Type ALDH

Opening Dimensions:
4-1/8" x 3/4"

Replacement Pad: BH-7235-90A

FOR ALM

Adjustable Slip-On Height Extension with Octagon Pad

Fits over BH-7250-01 Spin Up with Round Pad

BH-7150-52 • 4"-6" Adjustable
BH-7150-53 • 6"-9-1/2" Adjustable

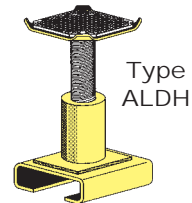

Type ALDH

Opening Dimensions:
6-1/2" x 1-5/16"

Replacement Pad: BH-7225-01

FOR CHALLENGER & VBM

Adjustable Slip-On Height Extension with Octagon Pad

Fits over BH-7225-01 Rubber Pad

BH-7227-49 • 4"-6" Adjustable
BH-7227-50 • 6"-9-1/2" Adjustable

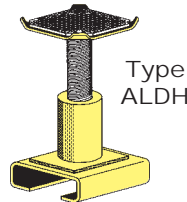

Type ALDH

Opening Dimensions:
6-1/8" x 1"

Replacement Pad: BH-7225-01

FOR FORWARD LIFTS, VBM (OLD SQUARE) & WORTH

Adjustable Slip-On Height Extension with Octagon Pad

Fits over Spin-Up with Corners Turned Up and BH-7235-90A Pad. VBM Old Square is Flat.

BH-7236-77 • 4"-6" Adjustable
BH-7236-78 • 6"-9-1/2" Adjustable

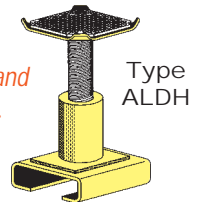

Type ALDH

Opening Dimensions:
5-3/4" x 15/16"

Replacement Pad: BH-7235-90A

FOR GILBARCO LIFTS

Adjustable Slip-On Height Extension with Octagon Pad

Fits over Spin-Up with 4 Corners turned up with BH-7350-00 / K93223 Pad

BH-7353-48 • 4"-6" Adjustable
BH-7353-49 • 6"-9.5" Adjustable

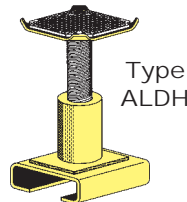

Type ALDH

Opening Dimensions:
5-3/16" x 3/4"

Replacement Pad: BH-7235-90A

FOR GLOBE LIFTS AND FORD SMITH LIFTS

Adjustable Slip-On Height Extension with Octagon Pad

Fits over BH-7250-01 Rubber Pad

BH-7250-06 • 6"-9.5" Adjustable

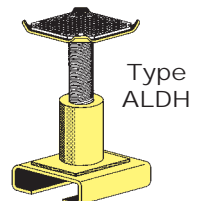

Type ALDH

Opening Dimensions:
4-9/16" x 1-3/16"

Replacement Pad: BH-7225-01

Height Extensions and Adapters By Type / Style

Please always confirm dimensions before ordering. Height Extensions and Adapters come in many different styles and dimensions. SVI is well-known as the adapter expert, specializing in top quality standard and custom adapters. SVI is your answer.

ALDH Slip-Over Height Extension Adapter - ADJUSTABLE Height Continued

FOR GRAND, AMERICAN, AND EAGLE LIFTS

Adjustable Slip-On Height Extension with Octagon Pad

Fits over Spin-Up with Corners Turned Up

BH-7376-39 • 4"–6" Adjustable
BH-7376-39H • 6"–9-1/2" Adjustable

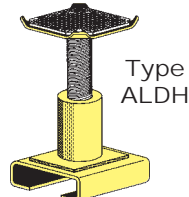

Type ALDH

Opening Dimensions:
5-3/16" x 25/32"

Replacement Pad: BH-7235-90A

FOR HYDRA-LIFT

Adjustable Slip-On Height Extension with Octagon Pad

Fits over Adapter without Pad

BH-7290-58 • 4"–6" Adjustable
BH-7290-59 • 6"–9-1/2" Adjustable

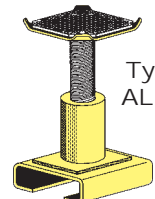

Type ALDH

Opening Dimensions:
4-2/3" x 1"

Replacement Pad: BH-7235-90A

FOR MANITOWOC LIFTS

Adjustable Slip-On Height Extension with Octagon Pad

Fits over spin-up with 2 sides turned up that had BH-7350-00 / K93223 Pad

BH-7353-50 • 4"–6" Adjustable
BH-7353-51 • 6"–9-1/2" Adjustable

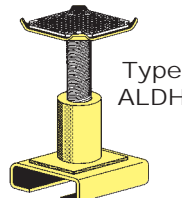

Type ALDH

Opening Dimensions:
5-1/4" x 1/2"

Replacement Pad: BH-7235-90A

FOR P.M.W., LINE-O-TRONICS (L.O.T.), KWIK-WAY

Adjustable Slip-On Height Extension with Octagon Pad

BH-7438-06 • 6"–9-1/2" Adjustable

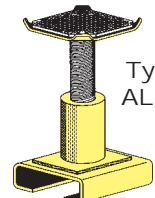

Type ALDH

Opening Dimensions:
5-1/8" x 1"

Replacement Pad: BH-7435-07

FOR NUSSBAUM & FORCE

Adjustable Slip-On Height Extension with Octagon Pad

Fits over Spin-Up with Round Pad

BH-7450-44 • 4"–6" Adjustable
BH-7450-45 • 6"–9-1/2" Adjustable

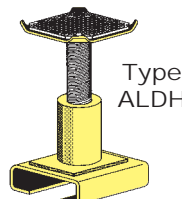

Type ALDH

Opening Dimensions:
5-3/8" x 1-1/8"

Replacement Pad: BH-7235-90A

FOR POWERREX

Adjustable Slip-On Height Extension with Octagon Pad

BH-7560-02 • 4"–6" Adjustable

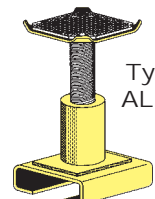

Type ALDH

Opening Dimensions:
5-3/16" x 1"

Replacement Pad: BH-7225-01



Height Extensions and Adapters By Type / Style

Please always confirm dimensions before ordering. Height Extensions and Adapters come in many different styles and dimensions. SVI is well-known as the adapter expert, specializing in top quality standard and custom adapters. SVI is your answer.

LDR Slip-Over Height Extension Adapter - **FIXED** Height
 For American (old / new), Benwil, Bishamon, Eagle (old / new), Globe, Grand (old / new), Hydra-Lift, Manitowoc Lifts, Nussbaum, Force, Western, Worth (old), others

With Rectangle Pad

Features Rectangle Rubber Pad BH-7205 (Ref 100533)



4-3/8" x 3-1/2"

BH-7205 Individual Arm Pad
 BH-7205-4 Kit of 4 Pads and Fasteners

Note: This pad is molded around a steel insert for stay put attachment to the lift arm.



Cross-section showing steel insert.

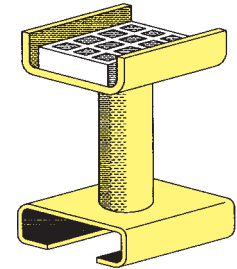
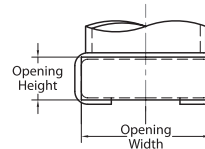

This is a **FIXED** STYLE Height Extension.

FOR AMERICAN (OLD), EAGLE (OLD), GRAND (OLD)

Slip-On Height Extension with Rectangle Rubber Pad
 Old Style

Fits over Spin-Up with X-Pattern Rubber Pad

- BH-7376-10 • 3" Extension
- BH-7376-11 • 4" Extension
- BH-7376-12 • 5" Extension
- BH-7375-02 • 6" Extension
- BH-7376-14 • 7" Extension

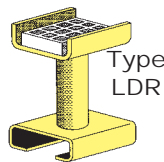

Type LDR

Opening Dimensions:
4-1/4" x 1-1/8"

Replacement Pad: BH-7205

FOR BENWIL, BISHAMON

Slip-On Height Extension
 BH-7202-50 • 3" Extension
 BH-7202-53 • 6" Extension
Fits over BH-7205 Rectangle Pad on Spin-Up

Type LDR

Opening Dimensions:
3-3/4" x 1-1/4"

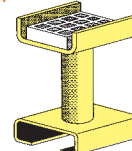

Replacement Pad: BH-7205

FOR GLOBE LIFTS

Slip-On Height Extension
 BH-7253-10 • 3" Extension
 BH-7253-11 • 4" Extension
 BH-7253-12 • 5" Extension
 BH-7253-13 • 6" Extension
 BH-7253-14 • 7" Extension

Opening Dimensions:
3-3/8" x 1-5/16"



Type LDR

Replacement Pad: BH-7205

FOR GILBARCO LIFTS

Slip-On Height Extension
Fits over BH-7350-00 / K93223

- BH-7353-06 • 3" Extension
- BH-7353-07 • 4" Extension
- BH-7353-08 • 5" Extension
- BH-7353-09 • 6" Extension
- BH-7353-10 • 7" Extension

Opening Dimensions:
5-3/16" x 3/4"



Type LDR

Replacement Pad: BH-7205

FOR HYDRA-LIFT

Fixed Slip-On Height Extension with Rectangle Pad
Fits over Hydra-Lift Adapter without Pad

- BH-7290-16 • 3" Extension
- BH-7290-17 • 4" Extension
- BH-7290-18 • 5" Extension
- BH-7290-19 • 6" Extension
- BH-7290-20 • 7" Extension

Features Replaceable Rubber Pad BH-7205

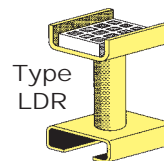

Type LDR

Opening Dimensions:
4-2/3" x 1"

FOR MANITOWOC LIFTS

Slip-On Height Extension
 BH-7353-11 • 3" Extension
 BH-7353-12 • 4" Extension
 BH-7353-13 • 5" Extension
 BH-7353-14 • 6" Extension
 BH-7353-15 • 7" Extension

Opening Dimensions:
5-1/4" x 1/2"



Type LDR

Replacement Pad: BH-7205

FOR NUSSBAUM AND FORCE

Fixed Slip-On Height Extension Adapter with Rectangle Pad
Fits over Spin-Up with Round Pad (BH-7450-02 / ref 10.157)

- BH-7450-23 • 3" Extension
- BH-7450-24 • 4" Extension
- BH-7450-25 • 5" Extension
- BH-7450-26 • 6" Extension
- BH-7450-27 • 7" Extension

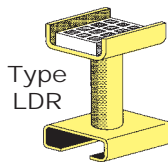

Type LDR

Opening Dimensions:
5-3/8" x 1-1/8"

Features Replaceable Rubber Pad BH-7205

FOR WESTERN

Fixed Slip-On Height Extension Adapter with Rectangle Pad
Fits over Spin-Up with X-Pattern Rectangular Pad (BH-7750-02)

- BH-7749-97 • 3" Extension
- BH-7749-98 • 4" Extension
- BH-7749-99 • 5" Extension
- BH-7750-01 • 6" Extension
- BH-7750-09 • 7" Extension

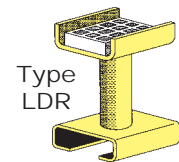

Type LDR

Opening Dimensions:
4-3/16" x 1-1/8"

Features Replaceable Rubber Pad BH-7205

Height Extensions and Adapters By Type / Style

Please always confirm dimensions before ordering. Height Extensions and Adapters come in many different styles and dimensions. SVI is well-known as the adapter expert, specializing in top quality standard and custom adapters. SVI is your answer.

HDR Slip-Over Height Extension Adapter - FIXED Height

For ALM, Ammco®* (New), Benwil, Bishamon, Challenger Lifts, Force, Forward Lifts, Gilbarco, Globe Lifts, Magnum, Manitowoc Lifts, Nussbaum, Phoenix, VBM, Western, others

Features Rectangle Rubber Pad BH-7205 (Ref 100533)



4-3/8" x 3-1/2"

- BH-7205 Individual Arm Pad
- BH-7205-4 Kit of 4 Pads and Fasteners

Note: This pad is molded around a steel insert for stay put attachment to the lift arm.



Cross-section showing steel insert.

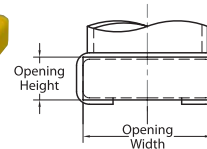

With Rectangle Pad

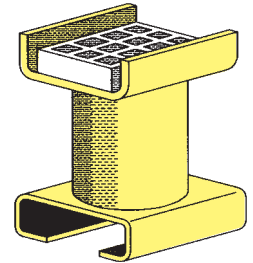

This is a FIXED STYLE Height Extension. See Type AHDR for Adjustable Version.

FOR ALM LIFTS

Fixed Slip-On Height Extension with Rectangle Pad

Fits over BH-7150-02 Round Pad

- BH-7150-42 • 3" Extension
- BH-7150-43 • 4" Extension
- BH-7150-44 • 5" Extension
- BH-7150-45 • 6" Extension
- BH-7150-46 • 7" Extension
- BH-7150-47 • 8" Extension
- BH-7150-48 • 9" Extension
- BH-7150-49 • 10" Extension
- BH-7150-50 • 11" Extension
- BH-7150-51 • 12" Extension

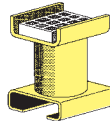

Type HDR

Opening Dimensions: 6-1/2" x 1-5/16"

Replacement Pad: BH-7205

FOR BENWIL & BISHAMON LIFTS

Slip-On Height Extension with Rectangle Pad

Fits over Spin-Up with BH-7205 Rectangle Pad

- BH-7202-55 • 3" Extension
- BH-7202-56 • 4" Extension
- BH-7200-12 • 6" Extension (Ref 100987)
- BH-7202-58 • 7" Extension
- BH-7202-59 • 8" Extension
- BH-7200-12L • 9" Extension

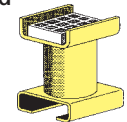

Type HDR

Opening Dimensions: 3-3/4" x 1-1/4"

Replacement Pad: BH-7205

(Not for square pads on TP-9)

FOR CHALLENGER LIFTS, AMMCO®* (NEW) & VBM

Fixed Slip-On Height Extension with Rectangle Pad

Fits over BH-7225-01 Rubber Pad

- BH-7227-31 • 3" Extension
- BH-7227-32 • 4" Extension
- BH-7227-33 • 5" Extension
- BH-7227-34 • 6" Extension
- BH-7227-35 • 7" Extension
- BH-7227-36 • 8" Extension
- BH-7227-37 • 9" Extension
- BH-7227-38 • 10" Extension
- BH-7227-39 • 11" Extension
- BH-7227-40 • 12" Extension

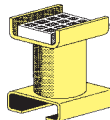

Type HDR

Opening Dimensions: 6-1/8" x 1"

Replacement Pad: BH-7205

FOR FORWARD LIFTS, VBM (OLD SQUARE)

Fixed Slip-On Height Extension with Rectangle Pad

Fits over Spin-Up with Four Corners Turned Up with BH-7235-90A Pad. VMB is flat.

- BH-7236-67 • 3" Extension
- BH-7236-68 • 4" Extension
- BH-7236-69 • 5" Extension
- BH-7236-70 • 6" Extension
- BH-7236-71 • 7" Extension
- BH-7236-72 • 8" Extension
- BH-7236-73 • 9" Extension
- BH-7236-74 • 10" Extension
- BH-7236-75 • 11" Extension
- BH-7236-76 • 12" Extension

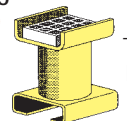

Type HDR

Opening Dimensions: 5-3/4" x 15/16"

Replacement Pad: BH-7205

FOR GILBARCO & MANITOWOC LIFTS

Fixed Slip-On Height Extension with Rectangle Pad

Fits over BH-7350-00 / K93223 Rubber Pad

- BH-7353-32 • 3" Extension
- BH-7353-33 • 4" Extension
- BH-7353-34 • 5" Extension
- BH-7353-35 • 6" Extension
- BH-7353-36 • 7" Extension
- BH-7353-37 • 8" Extension
- BH-7353-38 • 9" Extension
- BH-7353-39 • 10" Extension

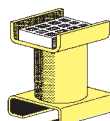

Type HDR

Opening Dimensions: 5-3/16" x 3/4"

Replacement Pad: BH-7205

FOR GLOBE LIFTS / FORD SMITH

Fixed Slip-On Height Extension with Rectangle Pad

Fits over Flat Rectangular Pad BH-7250-01

- BH-7253-15 • 3" Extension
- BH-7253-16 • 4" Extension
- BH-7253-17 • 5" Extension
- BH-7250-05 • 6" Extension
- BH-7253-19 • 7" Extension
- BH-7253-20 • 8" Extension
- BH-7253-21 • 9" Extension
- BH-7253-22 • 10" Extension

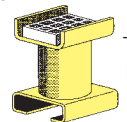

Type HDR

Opening Dimensions: 3-3/8" x 1-5/16"

Replacement Pad: BH-7205



Height Extensions and Adapters By Type / Style

Please always confirm dimensions before ordering. Height Extensions and Adapters come in many different styles and dimensions. SVI is well-known as the adapter expert, specializing in top quality standard and custom adapters. SVI is your answer.

HDR Slip-Over Height Extension Adapter - FIXED Height Continued

FOR GLOBE LIFTS (AFO'S)

Slip-On Height Extension with Rectangle Pad
Fits over BH-7250-01 Rubber Pad

- BH-7253-27 • 3" Extension
- BH-7253-28 • 4" Extension
- BH-7253-29 • 5" Extension
- BH-7253-30 • 7" Extension
- BH-7253-31 • 8" Extension
- BH-7253-32 • 9" Extension
- BH-7253-33 • 10" Extension

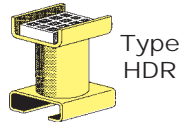

Opening Dimensions:
4-9/16" x 1-3/16"

Replacement Pad: BH-7205

FOR MAGNUM LIFTS

Fixed Slip-On Height Ext.
with Rectangle Pad
BH-7496-1005 • 5" Extension
BH-7496-1006 • 6" Extension

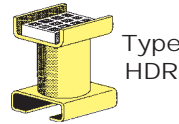

Opening Dimensions:
4-1/4" x 3/4"

Replacement Pad: BH-7205

FOR MANITOWOC LIFTS

Fixed Slip-On Height Extension with Rectangle Pad
Fits over spin-up with 2 sides turned up with BH-7350-00 / K93223 Pad

- BH-7353-40 • 3" Extension
- BH-7353-41 • 4" Extension
- BH-7353-42 • 5" Extension
- BH-7353-43 • 6" Extension
- BH-7353-44 • 7" Extension
- BH-7353-45 • 8" Extension
- BH-7353-46 • 9" Extension
- BH-7353-47 • 10" Extension

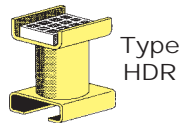

Opening Dimensions:
5-1/4" x 1/2"

Replacement Pad: BH-7205

FOR NUSSBAUM, FORCE & PHOENIX

Fixed Slip-On Height Extension with Rectangle Pad
Fits over Spin-Up with Round Pad

- BH-7450-36 • 3" Extension
- BH-7450-37 • 4" Extension
- BH-7450-38 • 5" Extension
- BH-7450-39 • 6" Extension
- BH-7450-40 • 7" Extension
- BH-7450-41 • 8" Extension
- BH-7450-42 • 9" Extension
- BH-7450-43 • 10" Extension

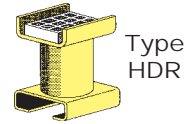

Opening Dimensions:
5-3/8" x 1-1/8"

Replacement Pad: BH-7205

FOR WESTERN LIFTS

Slip-On Height Extension
Fits over BH-7750-02 (ref S-350) Pad

- BH-7749-93 • 3" Extension
- BH-7749-94 • 4" Extension
- BH-7749-95 • 5" Extension
- BH-7749-96 • 6" Extension

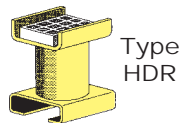

Opening Dimensions:
4-3/16" x 1-1/8"

Replacement Pad: BH-7205

Height Extensions and Adapters By Type / Style

Please always confirm dimensions before ordering. Height Extensions and Adapters come in many different styles and dimensions. SVI is well-known as the adapter expert, specializing in top quality standard and custom adapters. SVI is your answer.

AHDR Slip-Over Height Extension Adapter - ADJUSTABLE Height

For ALM, Ammco®* (New), Benwil, Bishamon, Challenger Lifts, Force, Forward Lifts, Gilbarco, Globe Lifts, Magnum, Manitowoc Lifts, Nussbaum, Phoenix, VBM, Western, Worth, others

With Rectangle Pad

Features Rectangle Rubber Pad BH-7205 (Ref 100533)



4-3/8" x 3-1/2"

BH-7205 Individual Arm Pad
BH-7205-4 Kit of 4 Pads and Fasteners

Note: This pad is molded around a steel insert for stay put attachment to the lift arm.



Cross-section showing steel insert.

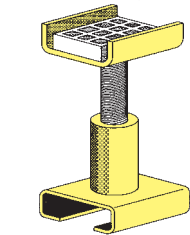
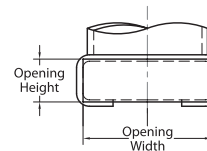

This is an ADJUSTABLE STYLE Height Extension. See Type HDR for Fixed Version.

FOR ALM LIFTS

Adjustable Slip-On Height Extension with Rectangle Pad
Fits over Spin-Up with BH-7150-02 Round Pad

BH-7150-54 • 4"–6" Adjustable
BH-7150-55 • 6"–9-1/2" Adjustable

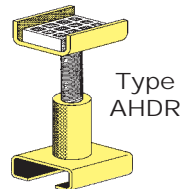

Type AHDR

Opening Dimensions:
6-1/2" x 1-5/16"

Replacement Pad: BH-7205

FOR BENWIL & BISHAMON LIFTS

Adjustable Slip-On Height Extension with Rectangle Pad
Fits over BH-7205 Rectangle Pads on Spin Up Adapter

BH-7202-63 • 4"–6" Adjustable
BH-7202-64 • 6"–9-1/2" Adjustable

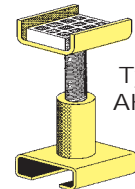

Type AHDR

Opening Dimensions:
3-3/4" x 1-1/4"

Replacement Pad: BH-7205

FOR CHALLENGER LIFTS & VBM

Adjustable Slip-On Height Extension with Rectangle Pad
Fits over Spin-Up with 4 Corners Turned Up with BH-7225-01 Rubber Pad

BH-7227-47 • 4"–6" Adjustable
BH-7227-48 • 6"–9-1/2" Adjustable

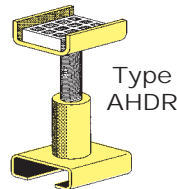

Type AHDR

Opening Dimensions:
6-1/8" x 1"

Replacement Pad: BH-7205

FOR EAGLE, GRAND, WORTH (OLD), OTHERS

Adjustable Slip-On Height Extension with Rectangle Pad
Fits over Spin-Up with X-Pattern Rubber Pad

BH-7376-40 • 4"–6" Adjustable
BH-7376-41 • 6"–9-1/2" Adjustable

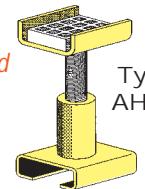

Type AHDR

Opening Dimensions:
4-1/4" x 1-1/8"

Replacement Pad: BH-7205

FOR FORWARD LIFTS, WORTH

Adjustable Slip-On Height Extension with Rectangle Pad
Fits over Spin-Up with BH-7235-90A Pad

BH-7236-79 • 4"–6" Adjustable
BH-7236-80 • 6"–9-1/2" Adjustable

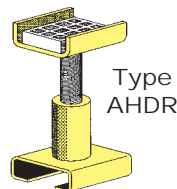

Type AHDR

Opening Dimensions:
5-3/4" x 15/16"

Replacement Pad: BH-7205

FOR GILBARCO LIFTS

Adjustable Slip-On Height Extension with Rectangle Pad
Fits over Spin-Up with 2 Sides turned up with BH-7350-00 / K93223 Pad

BH-7353-52 • 4"–6" Adjustable
BH-7353-53 • 6"–9-1/2" Adjustable

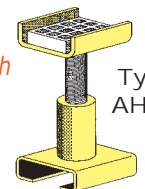

Type AHDR

Opening Dimensions:
5-3/16" x 3/4"

Replacement Pad: BH-7205



Height Extensions and Adapters By Type / Style

Please always confirm dimensions before ordering. Height Extensions and Adapters come in many different styles and dimensions. SVI is well-known as the adapter expert, specializing in top quality standard and custom adapters. SVI is your answer.

AHDR Slip-Over Height Extension Adapter - ADJUSTABLE Height Continued

FOR GLOBE LIFTS (AFO'S)
Adjustable Slip-On Height Extension with Rectangle Pad

BH-7253-25 • 4"–6" Adjustable
BH-7253-26 • 6"–9-1/2" Adjustable

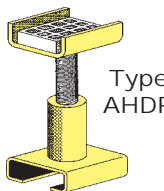

Type AHDR

Opening Dimensions:
4-9/16" x 1-3/16"

Replacement Pad: BH-7205

FOR GLOBE LIFTS
Adjustable Slip-On Height Extension with Rectangle Pad

BH-7253-23 • 4"–6" Adjustable
BH-7253-24 • 6"–9-1/2" Adjustable

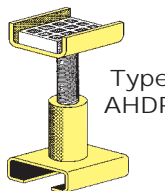

Type AHDR

Opening Dimensions:
3-3/8" x 1-5/16"

Replacement Pad: BH-7205

FOR AMERICAN, EAGLE, GRAND
Adjustable Slip-On Height Extension with Rectangle Pad
Fits over Spin-Up with four Corners turned up.

BH-7376-42 • 4"–6" Adjustable
BH-7376-43 • 6"–9-1/2" Adjustable



Type AHDR

Opening Dimensions:
5-3/16" x 25/32"

Replacement Pad: BH-7205

FOR HYDRA-LIFT
Adjustable Slip-On Height Extension with Rectangle Pad
Fits over Adapter without Pad

BH-7290-62 • 4"–6" Adjustable
BH-7290-63 • 6"–9-1/2" Adjustable

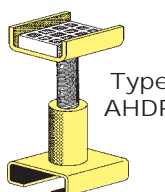

Type AHDR

Opening Dimensions:
4-2/3" x 1"

Replacement Pad: BH-7205

FOR HYDRA-LIFT
Adjustable Slip-On Height Extension with Rectangle Pad
Fits over Spin-Up with Round Rubber Pad BH-7450-02

BH-7290-64 • 4"–6" Adjustable
BH-7290-65 • 6"–9-1/2" Adjustable

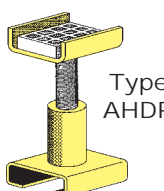

Type AHDR

Replacement Pad: BH-7205

FOR MANITOWOC LIFTS
Adjustable Slip-On Height Extension with Rectangle Pad
Fits over Spin-Up with 2 Sides turned up with BH-7350-00 / K93223 Pad

BH-7353-54 • 4"–6" Adjustable
BH-7353-55 • 6"–9-1/2" Adjustable

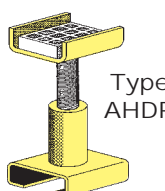

Type AHDR

Opening Dimensions:
5-1/4" x 1/2"

Replacement Pad: BH-7205

FOR NUSSBAUM & FORCE
Adjustable Slip-On Height Extension with Rectangle Pad
Fits over Spin-Up with Round Pad

BH-7450-46 • 4"–6" Adjustable
BH-7450-47 • 6"–9-1/2" Adjustable

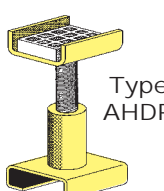

Type AHDR

Opening Dimensions:
5-3/8" x 1-1/8"

Replacement Pad: BH-7205

FOR WESTERN
Adjustable Slip-On Height Extension with Rectangle Pad
Fits over Spin-Up with X-Pattern Pad BH-7750-02

BH-7749-91 • 4"–6" Adjustable
BH-7749-92 • 6"–9-1/2" Adjustable

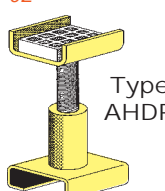

Type AHDR

Opening Dimensions:
4-3/16" x 1-1/8"

Replacement Pad: BH-7205

Height Extensions and Adapters By Type / Style

Please always confirm dimensions before ordering. Height Extensions and Adapters come in many different styles and dimensions. SVI is well-known as the adapter expert, specializing in top quality standard and custom adapters. SVI is your answer.

HDRNRW Narrow Slip-Over Height Extension Adapter - FIXED Height

For Close-to-Frame Obstructions—Commonly sold for use on the rear of late model trucks. Avoids denting or puncturing fuel tank and smashing brake lines.

For Alamo / ASSSA, ALM, American, Ammco®* (new), Benwil, Bishamon, Challenger, Eagle, Force, Forward Lifts, Gilbarco, Globe Lifts, Grand, Hydra-Lift, Manitowoc Lifts, Nussbaum, Phoenix, VBM, Western, Worth, others

Features Rectangle Rubber Pad (Varies Per Adapter)

With Narrow Rectangle Pad



BH-9900-10A Individual Arm Pad

BH-9755-50-1 Individual Arm Pad

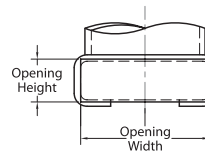

This is a FIXED STYLE Height Extension. See Type AHDRNRW for Adjustable Version.

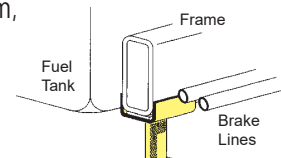

Type HDRNRW

FOR ALAMO / ASSSA LIFTS

Slip-On Narrow Height Extension for Close to Frame Obstructions

Fits over BH-7165-02 Pad

- BH-7165-20 • 3" Extension
- BH-7165-21 • 6" Extension
- BH-7165-22 • 9" Extension

Adjustable version also available.

Replacement Pad: BH-9900-10A

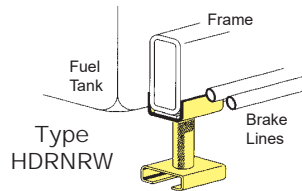

Type HDRNRW

Opening Dimensions:
4-1/8" x 3/4"

FOR ALM LIFTS

Slip-On Narrow Height Extension for Close to Frame Obstructions

Fits over Spin-Up with Round Pad

- BH-7150-72 • 3" Extension
- BH-7150-73 • 6" Extension
- BH-7150-74 • 9" Extension

Adjustable version also available.

Replacement Pad: BH-9900-10A

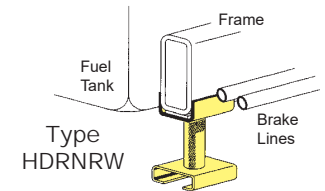

Type HDRNRW

Opening Dimensions:
6-1/2" x 1-5/16"

FOR CHALLENGER LIFTS, AMMCO®* (NEW) & VBM

Slip-On Narrow Height Extension for Close to Frame Obstructions

Fits over BH-7225-01 Rubber Pad

- BH-7229-72 • 3" Extension
- BH-7229-73 • 6" Extension
- BH-7229-74 • 9" Extension

Adjustable version also available.

Replacement Pad: BH-9755-50-1

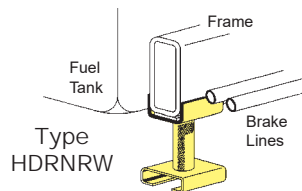

Type HDRNRW

Opening Dimensions:
6-1/8" x 1"

FOR FORWARD LIFTS & WORTH

Slip-On Narrow Height Extension for Close to Frame Obstructions

Fits over Spin-Up with BH-7235-90A

- BH-7236-81 • 3" Extension
- BH-7236-82 • 6" Extension
- BH-7236-83 • 9" Extension

Adjustable version also available.

Replacement Pad: BH-9755-50-1

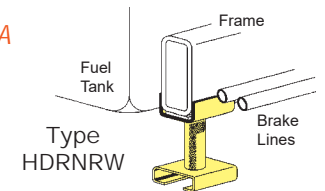

Type HDRNRW

Opening Dimensions:
5-3/4" x 15/16"

FOR GILBARCO & MANITOWOC LIFTS

Slip-On Narrow Height Extension for Close to Frame Obstructions

Fits over BH-7350-00 / K93223 Pad

- BH-7353-56 • 3" Extension
- BH-7353-57 • 6" Extension
- BH-7353-58 • 9" Extension

Adjustable version also available.

Replacement Pad: BH-9900-10A

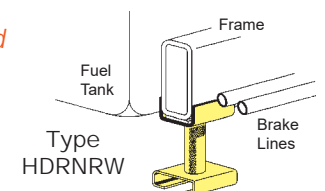

Type HDRNRW

Opening Dimensions:
5-3/16" x 3/4"



Height Extensions and Adapters By Type / Style

Please always confirm dimensions before ordering. Height Extensions and Adapters come in many different styles and dimensions. SVI is well-known as the adapter expert, specializing in top quality standard and custom adapters. SVI is your answer.

HDRNRW Narrow Slip-Over Height Extension Adapter - FIXED Height Continued

FOR GLOBE LIFTS
Slip-On Narrow Height Extension
for Close to Frame Obstructions

- BH-7253-46 • 3" Extension
- BH-7253-47 • 6" Extension
- BH-7253-48 • 9" Extension

Adjustable version also available.

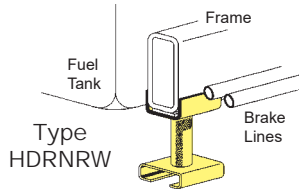

Opening Dimensions:
3-3/8" x 1-5/16"

Replacement Pad: BH-9755-50-1

FOR GLOBE LIFTS (AFO'S)
Slip-On Narrow Height Extension
for Close to Frame Obstructions

Fits over BH-7250-01 Rectangle Pad

- BH-7253-49 • 3" Extension
- BH-7253-50 • 6" Extension
- BH-7253-51 • 9" Extension

Adjustable version also available.

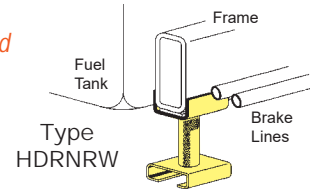

Opening Dimensions:
4-9/16" x 1-3/16"

Replacement Pad: BH-9755-50-1

FOR GRAND LIFTS (OLD)
Slip-On Narrow Height Extension
for Close to Frame Obstructions

Fits over Spin-Up with X-Pattern Pad

- BH-7376-44 • 3" Extension
- BH-7376-45 • 6" Extension
- BH-7376-46 • 9" Extension

Adjustable version also available.

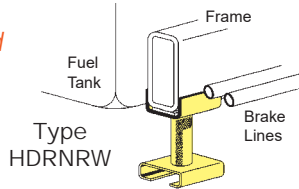

Opening Dimensions:
4-1/4" x 1-1/8"

Replacement Pad: BH-9900-10A

FOR GRAND LIFTS
Slip-On Narrow Height Extension
for Close to Frame Obstructions

Fits over Spin-Up with 4 Corners Turned Up

- BH-7376-47 • 3" Extension
- BH-7376-48 • 6" Extension
- BH-7376-49 • 9" Extension

Adjustable version also available.

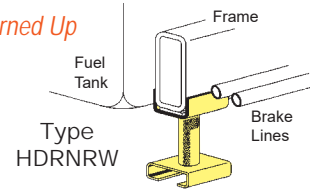

Opening Dimensions:
5-3/16" x 25/32"

Replacement Pad: BH-9900-10A

FOR HYDRA-LIFTS
Slip-On Narrow Height Extension
for Close to Frame Obstructions

Fits over Hydra-Lift Adapter without Pad

- BH-7292-48 • 3" Extension
- BH-7292-49 • 6" Extension
- BH-7292-50 • 9" Extension

Adjustable version also available.

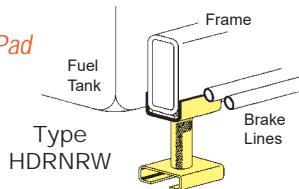

Opening Dimensions:
4-2/3" x 1"

Replacement Pad: BH-9755-50-1

FOR HYDRA-LIFTS
Slip-On Narrow Height Extension
for Close to Frame Obstructions

Fits over Hydra-Lift Adapter with Round Pad

- BH-7292-51 • 3" Extension
- BH-7292-52 • 6" Extension
- BH-7292-53 • 9" Extension

Adjustable version also available.

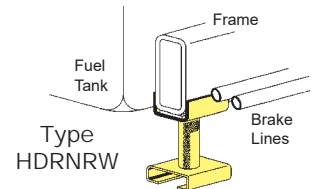

Opening Dimensions:
5-1/8" x 1-5/16"

Replacement Pad: BH-9755-50-1

FOR MANITOWOC LIFTS
Slip-On Narrow Height Extension
for Close to Frame Obstructions

Fits over Spin-Up with 2 Sides Turned Up with BH-7350-00 / K93223 Pad

- BH-7353-59 • 3" Extension
- BH-7353-60 • 6" Extension
- BH-7353-61 • 9" Extension

Adjustable version also available.

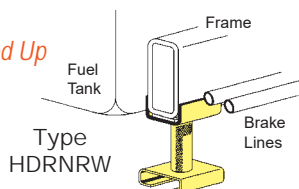

Opening Dimensions:
5-1/4" x 1/2"

Replacement Pad: BH-9900-10A

FOR NUSSBAUM LIFTS
Slip-On Narrow Height Extension
for Close to Frame Obstructions

For Nussbaum Models with Round Rubber Pads

- BH-7450-58 • 3" Extension
- BH-7450-59 • 6" Extension
- BH-7450-60 • 9" Extension

Adjustable version also available.

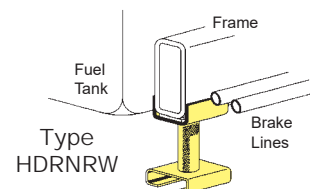

Opening Dimensions:
5-3/8" x 1-1/8"

Replacement Pad: BH-9755-50-1

Height Extensions and Adapters By Type / Style

Please always confirm dimensions before ordering. Height Extensions and Adapters come in many different styles and dimensions. SVI is well-known as the adapter expert, specializing in top quality standard and custom adapters. SVI is your answer.

HDRNRW Narrow Slip-Over Height Extension Adapter - FIXED Height Continued

FOR WERTHER LIFTS

Slip-On Narrow Height Extension for Close to Frame Obstructions

- BH-7587-14 • 3" Extension
- BH-7587-15 • 6" Extension
- BH-7587-16 • 9" Extension

Adjustable version also available.

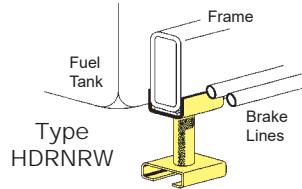

Opening Dimensions:
5-5/8" x 1-3/16"

Replacement Pad Available

FOR WESTERN LIFTS

Slip-On Narrow Height Extension for Close to Frame Obstructions

Fits over Spin-Up with Flat X-Pattern Rectangle Pad

- BH-7749-88 • 3" Extension
- BH-7749-89 • 6" Extension
- BH-7749-90 • 9" Extension

Adjustable version also available.

Replacement Pad: BH-9755-50-1

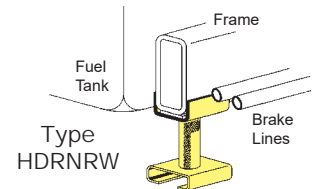

Opening Dimensions:
4-3/16" x 1-1/8"



Height Extensions and Adapters By Type / Style

Please always confirm dimensions before ordering. Height Extensions and Adapters come in many different styles and dimensions. SVI is well-known as the adapter expert, specializing in top quality standard and custom adapters. SVI is your answer.

AHDRNRW Narrow Slip-Over Height Extension Adapter - ADJUSTABLE Height
 For Close-to-Frame Obstructions—Commonly sold for use on the rear of late model trucks. Avoids denting or puncturing fuel tank and smashing brake lines.

For Alamo / ASSSA, ALM, American, Ammco®* (new), Benwil, Bishamon, Challenger, Eagle, Force, Forward Lifts, Gilbarco, Globe Lifts, Grand, Hydra-Lift, Manitowoc Lifts, Nussbaum, Phoenix, VBM, Western, Worth, others
 Features Rectangle Rubber Pad (Varies Per Adapter)

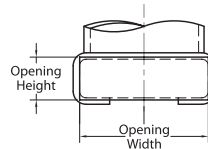
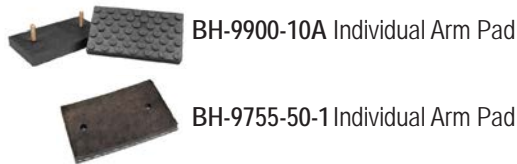

This is an ADJUSTABLE STYLE Height Extension. See Type HDRNRW for Fixed Version.

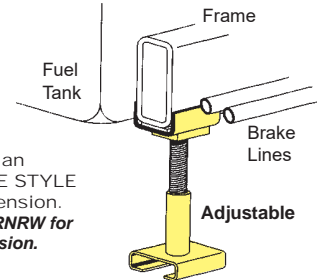

FOR ALAMO / ASSSA LIFTS
 Adjustable Slip-On Narrow Height Extension for Close to Frame Obstructions

Fits over BH-7165-02 Pad

BH-7165-23 • 4"–6" Adjustable
 BH-7165-24 • 6"–9" Adjustable

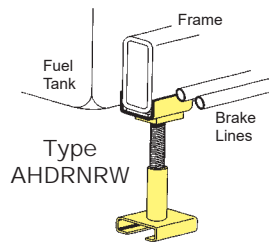

Opening Dimensions:
 4-1/8" x 3/4"

Replacement Pad Available

FOR ALM LIFTS
 Adjustable Slip-On Narrow Height Extension for Close to Frame Obstructions

Fits over Spin-Up with Round Pad

BH-7150-75 • 4"–6" Adjustable
 BH-7150-76 • 6"–9" Adjustable

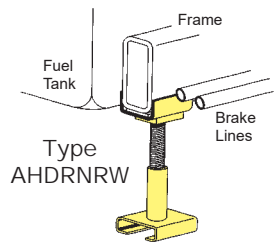

Opening Dimensions:
 6-1/2" x 1-5/16"

Replacement Pad: BH-9900-10A

FOR BENWIL & BISHAMON LIFTS
 Adjustable Slip-On Narrow Height Extension for Close to Frame Obstructions

Fits over BH-7205 Rectangle Pads on Spin Up Adapter

BH-7202-69 • 6"–9" Adjustable

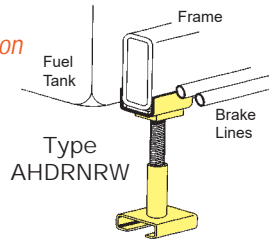

Opening Dimensions:
 3-3/4" x 1-1/4"

Replacement Pad: BH-9755-50-1

FOR CHALLENGER LIFTS, AMMCO®* (NEW) & VBM
 Adjustable Slip-On Narrow Height Extension for Close to Frame Obstructions

Fits over BH-7225-01 Rubber Pad

BH-7229-75 • 4"–6" Adjustable
 BH-7229-76 • 6"–9" Adjustable

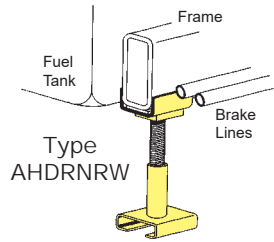

Opening Dimensions:
 6-1/8" x 1"

Replacement Pad: BH-9755-50-1

FOR FORWARD LIFTS, WORTH
 Adjustable Slip-On Narrow Height Extension for Close to Frame Obstructions

Fits over Spin-Up with BH-7235-90A Pad

BH-7236-84 • 4"–6" Adjustable
 BH-7236-85 • 6"–9-1/2" Adjustable

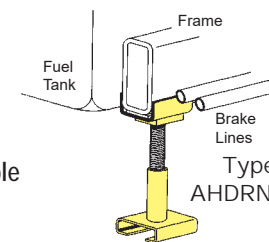

Opening Dimensions:
 5-3/4" x 15/16"

Replacement Pad: BH-9755-50-1

FOR GILBARCO LIFTS
 Adjustable Slip-On Narrow Height Extension for Close to Frame Obstructions

Fits over BH-7350-00 / K93223 Pad

BH-7353-62 • 4"–6" Adjustable
 BH-7353-63 • 6"–9" Adjustable

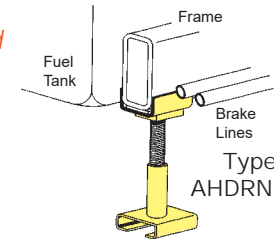

Opening Dimensions:
 5-3/16" x 3/4"

Replacement Pad: BH-9900-10A

Height Extensions and Adapters By Type / Style

Please always confirm dimensions before ordering. Height Extensions and Adapters come in many different styles and dimensions. SVI is well-known as the adapter expert, specializing in top quality standard and custom adapters. SVI is your answer.

AHDRNRW Narrow Slip-Over Height Extension Adapter - ADJUSTABLE Continued

FOR GLOBE LIFTS

Adjustable Slip-On Narrow Height Extension for Close to Frame Obstructions

BH-7253-52 • 4"–6" Adjustable
BH-7253-53 • 6"–9" Adjustable

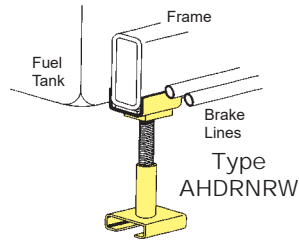

Opening Dimensions:
3-3/8" x 1-5/16"

Replacement Pad: BH-9975-50-1

FOR GLOBE LIFTS (AFO'S)

Adjustable Slip-On Narrow Height Extension for Close to Frame Obstructions

Fits BH-7250-01 Rectangle Pad

BH-7253-54 • 4"–6" Adjustable
BH-7253-55 • 6"–9" Adjustable

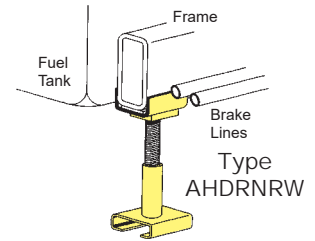

Opening Dimensions:
4-9/16" x 1-3/16"

Replacement Pad: BH-9975-50-1

FOR GRAND, AMERICAN, EAGLE

Adjustable Slip-On Narrow Height Extension for Close to Frame Obstructions

Fits over Spin-Up with 4 Corners Turned Up

BH-7376-52 • 4"–6" Adjustable
BH-7376-53 • 6"–9" Adjustable

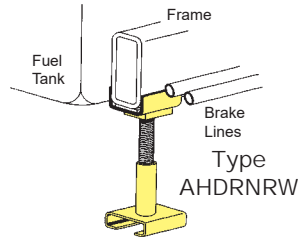

Opening Dimensions:
5-3/16" x 25/32"

Replacement Pad: BH-9900-10A

FOR GRAND, EAGLE, WORTH (OLD)

Adjustable Slip-On Narrow Height Extension for Close to Frame Obstructions

Fits over Spin-Up with X-Pattern Rubber Pad

BH-7376-50 • 4"–6" Adjustable
BH-7376-51 • 6"–9" Adjustable

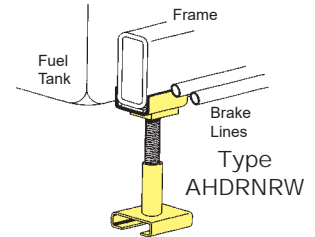

Opening Dimensions:
4-1/4" x 1-1/8"

Replacement Pad: BH-9900-10A

FOR HYDRA-LIFT

Adjustable Slip-On Narrow Height Extension for Close to Frame Obstructions

Fits over Hydra-Lift Adapter without Pad

BH-7292-54 • 4"–6" Adjustable
BH-7292-55 • 6"–9-1/2" Adjustable

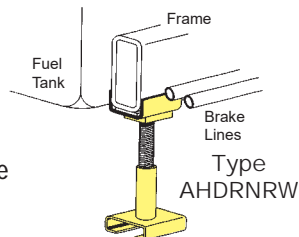

Opening Dimensions:
4-2/3" x 1"

Replacement Pad: BH-9755-50-1

FOR HYDRA-LIFT

Adjustable Slip-On Narrow Height Extension for Close to Frame Obstructions

Fits over Hydra-Lift Adapter with Round Pad

BH-7292-56 • 4"–6" Adjustable
BH-7292-57 • 6"–9-1/2" Adjustable

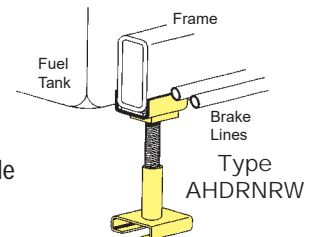

Opening Dimensions:
5-1/8" x 1-5/16"

Replacement Pad: BH-9755-50-1

FOR MANITOWOC LIFTS

Adjustable Slip-On Narrow Height Extension for Close to Frame Obstructions

Fits over Spin-Up with 2 Sides Turned Up with BH-7350-00 / K93223 Pad

BH-7353-64 • 4"–6" Adjustable
BH-7353-65 • 6"–9" Adjustable

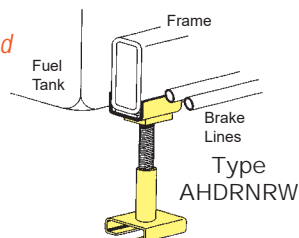

Opening Dimensions:
5-1/4" x 1/2"

Replacement Pad: BH-9900-10A

FOR NUSSBAUM & FORCE LIFTS

Adjustable Slip-On Narrow Height Extension for Close to Frame Obstructions

For Nussbaum Models with Round Rubber Pads

BH-7450-61 • 4"–6" Adjustable
BH-7450-62 • 6"–9-1/2" Adjustable

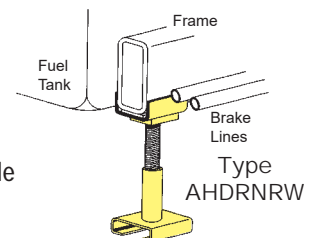

Opening Dimensions:
5-3/8" x 1-1/8"

Replacement Pad: BH-9755-50-1



Height Extensions and Adapters By Type / Style

Please always confirm dimensions before ordering. Height Extensions and Adapters come in many different styles and dimensions. SVI is well-known as the adapter expert, specializing in top quality standard and custom adapters. SVI is your answer.

AHDRNRW Narrow Slip-Over Height Extension Adapter - ADJUSTABLE Continued

FOR WERTHER LIFTS

Adjustable Slip-On Narrow Height Extension for Close to Frame Obstructions

- BH-7587-17 • 4"-6" Adjustable
- BH-7587-18 • 6"-9" Adjustable

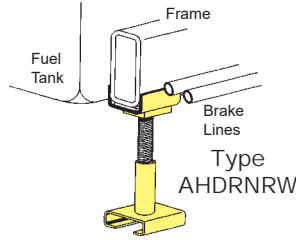

Opening Dimensions:
5-5/8" x 1-3/16"

Replacement Pad: BH-9755-50-1

FOR WESTERN

Adjustable Slip-On Narrow Height Extension for Close to Frame Obstructions

Fits over spin-up with flat rectangular pad with X Pattern

- BH-7749-86 • 4"-6" Adjustable
- BH-7749-87 • 6"-9" Adjustable

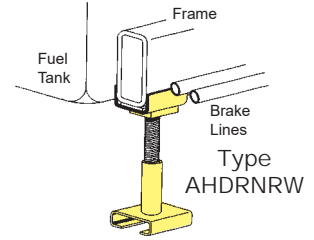

Opening Dimensions:
4-3/16" x 1-1/8"

Replacement Pad: BH-9755-50-1

Height Extensions and Adapters By Type / Style

Please always confirm dimensions before ordering. Height Extensions and Adapters come in many different styles and dimensions. SVI is well-known as the adapter expert, specializing in top quality standard and custom adapters. SVI is your answer.

LDRND Slip-Over Height Extension Adapter - FIXED Height

For BendPak, Force, Hydra-Lift, Nussbaum, Phoenix, and others

Features Round Rubber Pad BH-7450-02 (Ref 28335, 10.157)



BH-7450-02 Individual Arm Pad
 BH-7450-02-4 Kit of 4 Pads and Fasteners

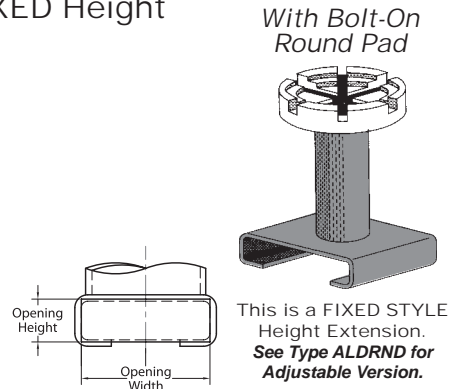

FOR BENDPAK

Fixed Slip-On Height Extension with Round Pad
 For P-6 Scissor Lift

- BH-7476-25 • 3" Extension
- BH-7476-26 • 4" Extension
- BH-7476-27 • 5" Extension
- BH-7476-28 • 6" Extension
- BH-7476-29 • 7" Extension
- BH-7476-30 • 8" Extension
- BH-7476-31 • 9" Extension

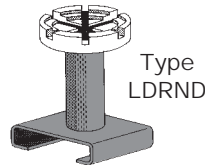

Type LDRND

Replacement Pad: BH-7450-02

FOR CHALLENGER LIFTS

Fixed Slip-On Height Extension with Round Pad

- BH-7240-20 • 6" Extension

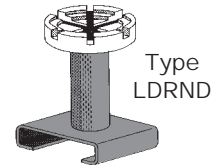

Type LDRND

Replacement Pad: BH-7450-02

FOR HYDRA-LIFT

Fixed Slip-On Height Extension with Round Pad
 Fits over Spin-Up with Round Pad

- BH-7290-66 • 3" Extension
- BH-7290-67 • 4" Extension
- BH-7290-68 • 5" Extension
- BH-7290-69 • 6" Extension
- BH-7290-70 • 7" Extension
- BH-7290-71 • 8" Extension
- BH-7290-72 • 9" Extension
- BH-7290-73 • 10" Extension

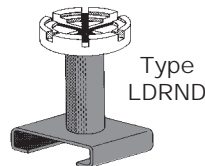

Type LDRND

Opening Dimensions:
 4-2/3" x 1"

Replacement Pad: BH-7450-02

FOR HYDRA-LIFT

Fixed Slip-On Height Extension with Round Pad
 Fits over Spin-Up with Round Pad

- BH-7290-74 • 3" Extension
- BH-7290-75 • 4" Extension
- BH-7290-76 • 5" Extension
- BH-7290-77 • 6" Extension
- BH-7290-78 • 7" Extension
- BH-7290-79 • 8" Extension
- BH-7290-80 • 9" Extension
- BH-7290-81 • 10" Extension

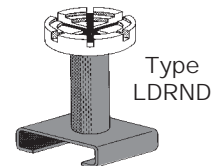

Type LDRND

Opening Dimensions:
 5-1/8" x 1-5/16"

Replacement Pad: BH-7450-02

FOR NUSSBAUM, FORCE & PHOENIX

Fixed Slip-On Height Extension with Round Pad
 Fits over Spin-Up with Round Pad

- BH-7450-48 • 3" Extension
- BH-7450-49 • 4" Extension
- BH-7450-50 • 5" Extension
- BH-7450-04 • 6" Extension
- BH-7450-52 • 7" Extension
- BH-7450-53 • 8" Extension
- BH-7450-54 • 9" Extension
- BH-7450-55 • 10" Extension

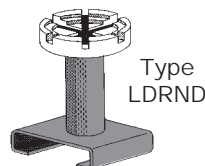

Type LDRND

Opening Dimensions:
 5-3/8" x 1-1/8"

Replacement Pad: BH-7450-02

FOR NUSSBAUM, OTHER

Fixed Slip-On Height Extension with Round Pad

- BH-7450-66 • 6" Extension

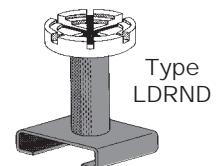

Type LDRND

Opening Dimensions:
 5-3/8" x 1-1/2"

Replacement Pad: BH-7450-02



Height Extensions and Adapters By Type / Style

Please always confirm dimensions before ordering. Height Extensions and Adapters come in many different styles and dimensions. SVI is well-known as the adapter expert, specializing in top quality standard and custom adapters. SVI is your answer.

ALDRND Slip-Over Height Extension Adapter - ADJUSTABLE Height

For BendPak, Force, Hydra-Lift, Nussbaum, Phoenix, and others

With Bolt-On Round Pad

Features Round Rubber Pad BH-7450-02 (Ref 28335, 10.157)

- BH-7450-02 Individual Arm Pad
- BH-7450-02-4 Kit of 4 Pads and Fasteners

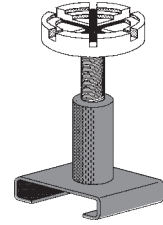
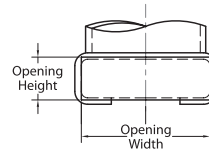

This is an ADJUSTABLE STYLE Height Extension. See Type LDRND for Fixed Version.

FOR BENDPAK

Fixed Slip-On Height Extension with Round Pad

For P-6 Scissor Lift

- BH-7476-32 • 4"-6" Adjustable
- BH-7476-33 • 6"-9-1/2" Adjustable

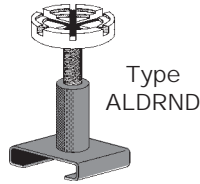

Type ALDRND

Replacement Pad: BH-7450-02

FOR HYDRA-LIFT

Adjustable Slip-On Height Extension with Round Pad

Fits over Spin-Up with Round Pad

- BH-7290-82 • 4"-6" Adjustable
- BH-7290-83 • 6"-9-1/2" Adjustable

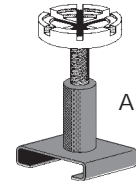

Type ALDRND

Opening Dimensions: 4-2/3" x 1"

Replacement Pad: BH-7450-02

FOR HYDRA-LIFT

Fixed Slip-On Height Extension with Round Pad

Fits over Spin-Up with Round Pad

- BH-7290-84 • 4"-6" Adjustable
- BH-7290-85 • 6"-9-1/2" Adjustable

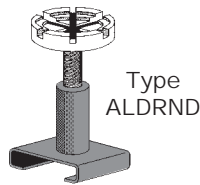

Type ALDRND

Opening Dimensions: 5-1/8" x 1-5/16"

Replacement Pad: BH-7450-02

FOR NUSSBAUM, FORCE & PHOENIX

Fixed Slip-On Height Extension with Round Pad

Fits over Spin-Up with Round Pad

- BH-7450-56 • 4"-6" Adjustable
- BH-7450-57 • 6"-9-1/2" Adjustable

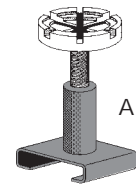

Type ALDRND

Opening Dimensions: 5-3/8" x 1-1/8"

Replacement Pad: BH-7450-02

Height Extensions and Adapters By Type / Style

Please always confirm dimensions before ordering. Height Extensions and Adapters come in many different styles and dimensions. SVI is well-known as the adapter expert, specializing in top quality standard and custom adapters. SVI is your answer.

ARND

For ALM Lifts

Slip-Over Height Extension Adapter - FIXED Height

Features Slip-Over Round Rubber Pad BH-7150-02 (Ref 9001)



BH-7150-02 Individual Arm Pad (1)

6-5/16" OD Pad

Pad Bottom Dimensions: 5-7/8" ID with Lip

With Slip-Over Round Pad

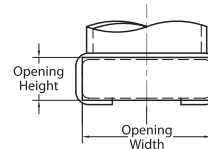
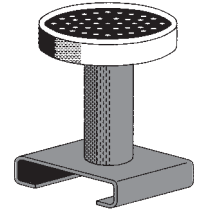

This is a FIXED STYLE Height Extension. See Type ALDRND for Adjustable Version.

FOR ALM LIFTS

Fixed Slip-On Height Extension with Round Pad

Fits over BH-7150-02 Round Pad

- BH-7150-22 • 3" Extension
- BH-7150-23 • 4" Extension
- BH-7150-24 • 5" Extension
- BH-7150-03 • 6" Extension
- BH-7150-25 • 7" Extension
- BH-7150-26 • 8" Extension
- BH-7150-04 • 9" Extension
- BH-7150-27 • 10" Extension

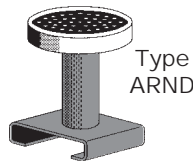

Type ARND

Opening Dimensions:
6-1/2" x 1-5/16"

Replacement Pad: BH-7150-02

AARND

For ALM Lifts

Slip-Over Height Extension Adapter - ADJUSTABLE Height

Features Slip-Over Round Rubber Pad BH-7150-02 (Ref 9001)



BH-7150-02 Individual Arm Pad (1)

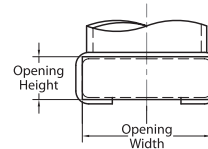

With Slip-Over Round Pad

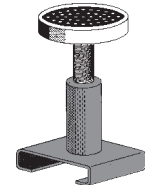

This is an ADJUSTABLE STYLE Height Extension. See Type LDRND for Fixed Version.

FOR ALM LIFTS

Fixed Slip-On Height Extension with Round Pad

Fits over BH-7150-02 Round Pad

- BH-7150-28 • 4"-6" Adjustable
- BH-7150-29 • 6"-9-1/2" Adjustable

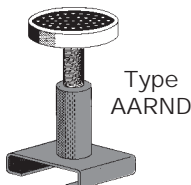

Type AARND

Opening Dimensions:
6-1/2" x 1-5/16"

Replacement Pad: BH-7150-02

Height Extensions and Adapters By Type / Style

Please always confirm dimensions before ordering. Height Extensions and Adapters come in many different styles and dimensions. SVI is well-known as the adapter expert, specializing in top quality standard and custom adapters. SVI is your answer.

For Challenger Lifts Slip-Over Height Extension Adapter

Available as either **FIXED** or **ADJUSTABLE** Style

For Challenger Lifts CL9, CL10, X10, and others

Slip-On Height Extension with Square Pad

Fits over BH-7232-17HDA-P Spin-Up Adapter with Square Pad

- BH-7231-96 3" Extension - **FIXED STYLE**
- BH-7232-00 (Ref A1105-06) 6" Extension - **FIXED STYLE**
- BH-7231-99 (Ref A1105-10) 10" Extension - **FIXED STYLE**

- BH-7231-97 4"-6" Extension - **ADJUSTABLE STYLE**
- BH-7231-98 6"-9-1/2" Extension - **ADJUSTABLE STYLE**

Features Square Rubber Pad BH-7232-01:

- BH-7232-01 (Ref A1104, B1104) 1 Pad
- BH-7232-01-4 (Ref A11052) Kit of 4 Pads with Fasteners



CL9
CL10
X10

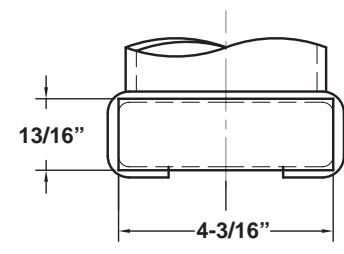

Adapter Base Inside Dimensions
Shape may vary depending on height extension.

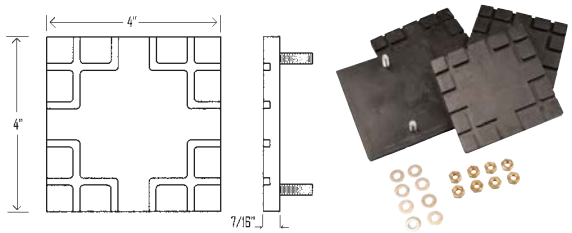

Height Extensions and Adapters By Type / Style

Please always confirm dimensions before ordering. Height Extensions and Adapters come in many different styles and dimensions. SVI is well-known as the adapter expert, specializing in top quality standard and custom adapters. SVI is your answer.

For Quality Lifts Slip-Over Height Extension Adapter - FIXED Height

For Quality Lifts Q10000, 9000AS, and other Korean-Made Lifts including Powerrex and Deona.

With Square Pad

Fixed Slip-On Height Extension with Square Pad
Fits over Double Screw-Up Adapter

Features Square Rubber Pad BH-7232-01

- BH-7234-01 • 5" Extension (1)
- BH-7234-01K • 5" Extension - Set of 4

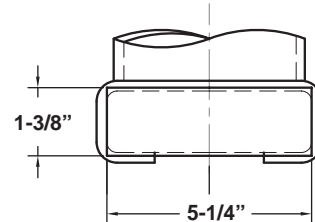

Adapter Base Inside Dimensions

This is a
FIXED STYLE
Height Extension.



*Fits over double
Screw-Up Adapter*



A distributor contacted SVI with a request asking that we produce slip-on height extensions for his customers that own Quality Lift model Q10000. Even though the lift is supplied standard with double screw-up style adapters, sometimes at full spin they still are not high enough. This means a slip-on height extension is necessary in certain situations and for certain vehicles. Of course, SVI responded to the request and is now pleased to let you know about our height extension for Quality Lifts Q10000, 9000AS, others.

When you have an idea, need something special or just simply want a problem you are encountering solved give us a call. We will see what we can come up with. SVI has an innovative can-do spirit and enjoys working on solutions to challenges and opportunities that you discover every day.

Available with or
without a rubber pad



Made in USA
This part features impeccable hand welding that would beat machines in a welding contest.

May also fit other Korean made lifts
Confirm dimensions but we think this will also fit Powerrex and Deona lifts that are produced in Korea

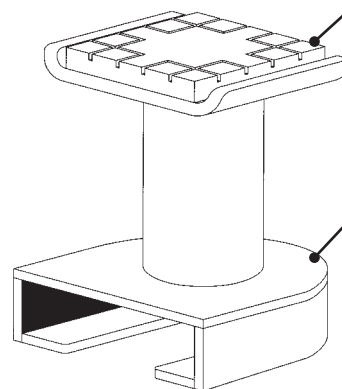

Fully enclosed radius back
Allows for quick and accurate placement on the lift's adapter.

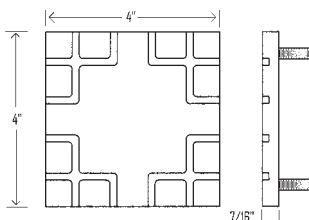

Features Square Rubber Pad BH-7232-01:

- BH-7232-01 (Ref A1104, B1104) 1 Pad
- BH-7232-01-4 (Ref A11052) Kit of 4 Pads with Fasteners

Height Extensions and Adapters By Type / Style

Please always confirm dimensions before ordering. Height Extensions and Adapters come in many different styles and dimensions. SVI is well-known as the adapter expert, specializing in top quality standard and custom adapters. SVI is your answer.

NS Nesting Style - FIXED Height For Any Lift using Nesting Style Extensions and Adapters

Possible Fitment by Pin OD—Always Confirm Dimensions on Lift:

- 1-1/8" Pin OD: For Mohawk, othes
- 1-1/4" Pin OD: For Forward Lifts, others
- 1-3/8" (35mm) Pin OD: For BendPak, Magnum, Mohawk, Pro-Lift, others
- 1-1/2" Pin OD: For ALM, Ammco®, Ben Pearson, Rotary, others
- 2-3/8" (60mm) Pin OD: For BendPak, others

SVI also makes Height Extension Hanger Brackets.

Don't see the right one for your size? Let us know!



NS • NESTING STYLE Height Extensions
See Type NSP for Compatible Pad Adapters.
Check Dimensions.

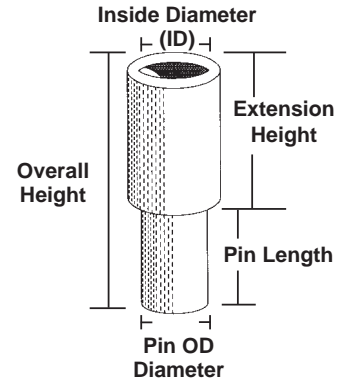

1-1/8" PIN OD • 1-7/8" PIN LENGTH • EXTENSION HEIGHT VARIES (LISTED BELOW)

For Weaver, and others
Nesting Style Height Extension

- BH-7606-36 (ref 1086636) 2-1/2" Extension
- BH-7606-37 3" Extension
- BH-7606-38 4" Extension
- BH-7606-35 (ref 1086635) 5" Extension
- BH-7606-39 6" Extension

ALSO AVAILABLE BH-7340-15BK (Ref 025-002-026)
Height Extension Hanger Bracket for 1-1/8" Adapters For Mohawk and others



Confirm Dimensions.

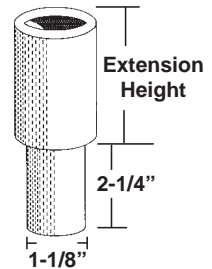

1-1/8" PIN OD • 2-1/4" PIN LENGTH • EXTENSION HEIGHT VARIES (LISTED BELOW)

For Mohawk A-7, System IA, RJ-25, and others
Nesting Style Height Extension

- BH-7340-12 (Ref 025-002-127) 3" Extension Height
- BH-7340-13 4" Extension Height
- BH-7340-14 5" Extension Height
- BH-7340-15 (Ref 025-002-128) 6" Extension Height

ALSO AVAILABLE BH-7340-15BK (Ref 025-002-026)
Height Extension Hanger Bracket for 1-1/8" Adapters For Mohawk and others



Confirm Dimensions.

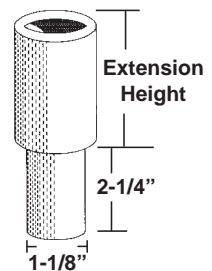

Height Extensions and Adapters By Type / Style

Please always confirm dimensions before ordering. Height Extensions and Adapters come in many different styles and dimensions. SVI is well-known as the adapter expert, specializing in top quality standard and custom adapters. SVI is your answer.

NS Nesting Style - FIXED Height Continued

1-1/4" PIN OD • 1-1/4" PIN LENGTH • EXTENSION HEIGHT VARIES (LISTED BELOW)

For Forward Lifts Models including 9000A, 10000A, 10000A2, DP7A, DP97A, DP97A2, DP97S, DP97S2, DP10A, DP10A2, DP10S, DP10S2, i10, and others

Nesting Style Height Extension

- BH-7235-72 (Ref 996220) 1-1/2" Extension Height
- BH-7089-98 (Ref 995560) 3" Extension Height
- BH-7089-99 4" Extension Height
- BH-7089-99A 5" Extension Height
- BH-7089-99B (Ref 995550) 6" Extension Height

BH-7239-120 (Ref 994257) Height Extension Kit (Includes 4 Each of 1-1/2", 3" & 6") Type NS

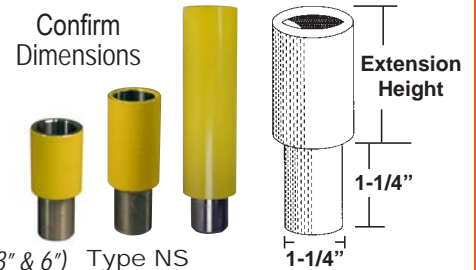

1-1/4" PIN OD • 2-1/2" PIN LENGTH • EXTENSION HEIGHT VARIES (LISTED BELOW)

For Ammco® Lifts (Newer) Models S21SS, S21SX, S290L, Wheeltronic Models 1492SA, 1776SVLG, others

Nesting Style Height Extension

- BH-7793-45 (Ref 1-1993) 3-1/4" Extension Height
- BH-7793-45L (Ref 1-1993x) 4-1/2" Extension Height
- BH-7796-04 (Ref 2-1580) 6" Extension Height

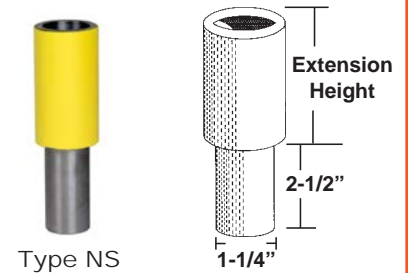

Height Extensions and Adapters By Type / Style

Please always confirm dimensions before ordering. Height Extensions and Adapters come in many different styles and dimensions. SVI is well-known as the adapter expert, specializing in top quality standard and custom adapters. SVI is your answer.

NS Nesting Style - FIXED Height Continued

1-3/8" (35MM) PIN OD • 1" PIN LENGTH • EXTENSION HEIGHT VARIES (LISTED BELOW)

For Tuxedo, and others

Nesting Style Height Extension

BH-7485-0108A	(Ref TP9-1038.1)	1" Extension Height
BH-7485-0109A	(Ref TP9-1039.1)	2" Extension Height
BH-7485-0108	(Ref TP9-1038)	3" Extension Height
BH-7485-0109	(Ref TP9-1039)	5" Extension Height

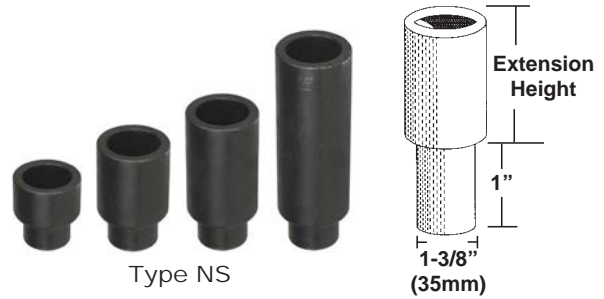

1-3/8" (35MM) PIN OD • 1-3/4" PIN LENGTH • EXTENSION HEIGHT VARIES (LISTED BELOW)

For BendPak, Magnum, Mohawk, Pro-Lift, and others

Nesting Style Height Extension

BH-7090-10	(Ref 5746390)	3" Extension Height
BH-7090-11		4" Extension Height
BH-7090-12		5" Extension Height
BH-7479-95	(Ref 5746395)	5-3/4" Extension Height (Pin Length 1-11/16")
BH-7090-13	(Ref 81691, 27982)	6" Extension Height

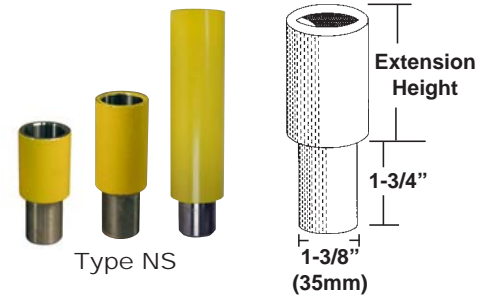

1-3/8" PIN OD • 3-1/4" PIN LENGTH • EXTENSION HEIGHT VARIES (LISTED BELOW)

For Mohawk LMF / TP-15, and others

Nesting Style Height Extension

BH-7340-17	(Ref 018-000-106)	5" Extension Height
BH-7340-18	(Ref 012-012-151)	7-1/2" Extension Height
BH-7340-19	(Ref 018-000-105)	10" Extension Height

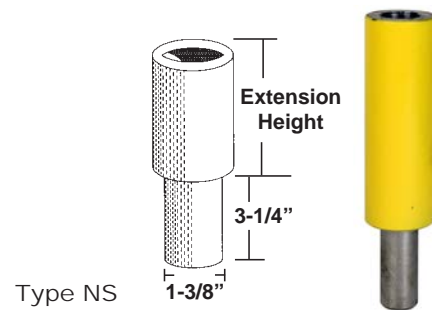

Height Extensions and Adapters By Type / Style

Please always confirm dimensions before ordering. Height Extensions and Adapters come in many different styles and dimensions. SVI is well-known as the adapter expert, specializing in top quality standard and custom adapters. SVI is your answer.

NS Nesting Style - FIXED Height Continued

1-1/2" OD PIN • 7/8" PIN LENGTH (EACH END) • EXTENSION HEIGHT VARIES (LISTED BELOW)

For Whip Lifts

Double-Ended Nesting Style Height Extension for Whip

- BH-7820-15 (ref ALIF-209-076-XX) 2" Extension
- BH-7820-16 (ref ALIF-209-077-XX) 4" Extension
- BH-7820-17 (ref ALIF-209-078-XX) 6" Extension
- BH-7820-18 (ref ALIF-209-210-XX) 8" Extension
- BH-7820-19 (ref ALIF-209-205-XX) 10" Extension

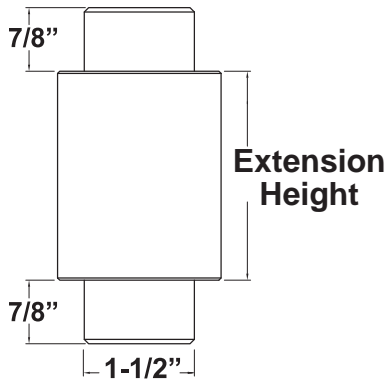

For Some Models:
Whip Lifts



BH-7820-15 thru -19

Nesting Style Height Extensions

Nesting Height Extensions Above Work
with BH-7820-09 Adapter and Pad

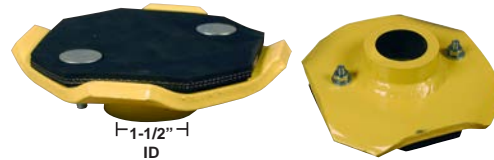

Adapter with Rubber Pad

Features BH-7820-04 Octagon Rubber Arm Pad

BH-7820-09 (Ref ALIF-209-086)

Use with Height Extensions Below: BH-7820-15 thru BH-7820-19



1-1/2" PIN OD • EXTENSION HEIGHT VARIES (LISTED BELOW)

For Atlas, and others

Nesting Style Height Extension

- BH-7166-260 (Ref 209052B) 2-1/2" (63mm) Extension Height
- BH-7166-261 (Ref 209053B) 5" (127mm) Extension Height

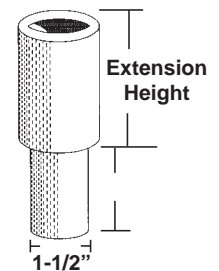

Type
NS

Height Extensions and Adapters By Type / Style

Please always confirm dimensions before ordering. Height Extensions and Adapters come in many different styles and dimensions. SVI is well-known as the adapter expert, specializing in top quality standard and custom adapters. SVI is your answer.

NS Nesting Style - FIXED Height Continued

1-1/2" PIN OD • 1-1/2" PIN LENGTH • EXTENSION HEIGHT VARIES (LISTED BELOW)

For Rotary Lifts - Many Models, and Others
Nesting Style Height Extension

- BH-7533-98S (Ref FJ6180) 2-1/2" Extension Height
- BH-7533-96 (Ref FJ6143) 4" Extension Height
- BH-7500-95 (Ref FJ6145) Hanger Bracket Rack
(without hardware)

Also See

- BH-7533-97 (Ref FJ6144) 8" Extension Height (1-1/2" OD Pin x 1-1/2" OD Pin)

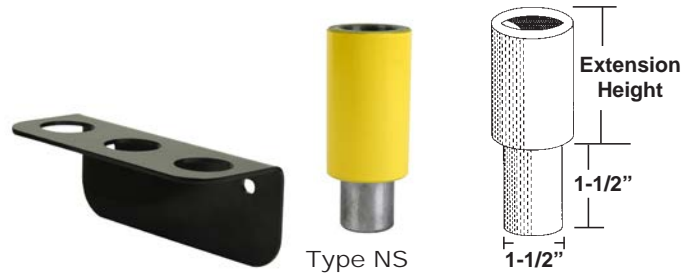

1-1/2" PIN OD • 1-1/2" PIN LENGTH • EXTENSION HEIGHT VARIES (LISTED BELOW)

For Rotary Lifts - For Many Models with TRIO Arms

Nesting Style Height Extension

- BH-7537-00 (Ref T130660) 3-1/2" (90mm) Extension Height
- BH-7537-01 (Ref T130661) 5" (130mm) Extension Height
- BH-7537-02 (Ref T130683) Height Extension Hanger Bracket for 1-1/2" Pin OD
Holds 4 Adapters (Includes 1 Rack & Hardware)

- BH-7536-90T (Ref T100271) Height Extension Kit for Lifts with TRIO Arms
(Includes (4) 3-1/2", (4) 5", and (2) Brackets)

Kit includes:

- (4) 5" Nesting Extension
- (4) 3-1/2" Nesting Extension
- (2) Hanger Brackets

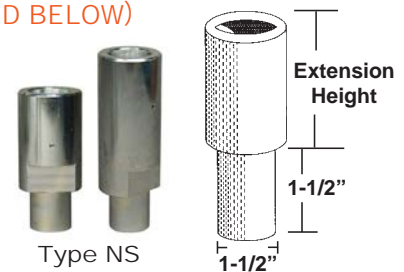

1-1/2" PIN OD • 2" PIN LENGTH • EXTENSION HEIGHT VARIES (LISTED BELOW)

For ALM, Ammco® Lifts, Ben Pearson, Challenger Lifts, Rotary Lifts, and others
Nesting Style Height Extension

- BH-7101-02 (Ref 81693, 27984, 91560) 2-5/8" Extension Height
- BH-7090-14 3" Extension Height
- BH-7101-04 (Ref 81692) 3-1/2" Extension Height
- BH-7090-15 4" Extension Height
- BH-7101-03 (Ref 81691, 27982, 91562) 5" Extension Height
- BH-7090-16 6" Extension Height
- BH-7090-17 7" Extension Height
- BH-7500-95 (Ref FJ6145) Hanger Bracket Rack *(without hardware)*



Height Extensions and Adapters By Type / Style

Please always confirm dimensions before ordering. Height Extensions and Adapters come in many different styles and dimensions. SVI is well-known as the adapter expert, specializing in top quality standard and custom adapters. SVI is your answer.

NS Nesting Style - FIXED Height Continued

1-1/2" PIN OD • 3-1/8" PIN LENGTH

For Rotary Lifts

BH-7533-97 (Ref FJ6144)
8" Nesting Style
Height Extension

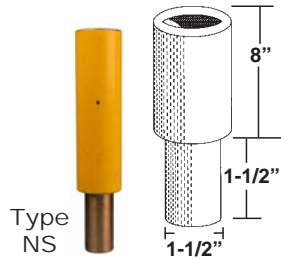

1.575" (40MM) PIN OD • 1-1/2" PIN LENGTH

Nesting Style
Height Extensions

Type NS

BH-7548-003 (Ref V12TP-4303) • 2" Extension
BH-7548-001 (Ref V12TP-4301) • 4-1/2" Extension
BH-7548-002 (Ref V12TP-4302) • 8-1/2" Extension

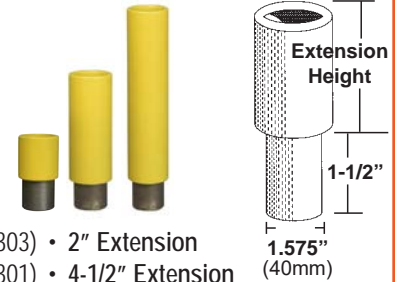

1-3/4" PIN OD • 1-1/2" PIN LENGTH

For Rotary Lifts

BH-7533-98 (Ref FJ6146)
3-1/2" Nesting Style
Height Extension

BH-7533-99 (Ref FJ6147)
5" Nesting Style
Height Extension



2" PIN OD • 1-3/4" PIN LENGTH • EXTENSION HEIGHT VARIES (LISTED BELOW)

For Rotary Lifts - Many Models with Round Adapter "RA" and Truck Adapter "TA" Models with Conventional Arms (NOT Trio Arms)

Nesting Style Height Extension

BH-7515-67 (Ref FJ6171-1B) 3-1/2" (90mm) Extension Height
BH-7515-66 (Ref FJ6171-2B, FJ6171-2ZN) 5" (130mm) Extension Height
BH-7515-68 (Ref FJ6171-2x) 8" (200mm) Extension Height

BH-7536-90A

Height Extension Hanger Bracket for 2" Pin OD
Holds 4 Adapters (Includes 1 Rack & Hardware)

BH-7536-90 (Ref FJ7880 / FJ7880BK)

Height Extension Kit
(Includes 4 Each 3-1/2" & 5" and Brackets)

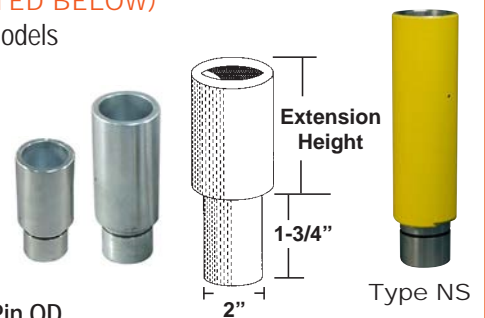

Kit includes:
(4) 5" Nesting Extension
(4) 3-1/2" Nesting Extension
(2) Hanger Brackets

Height Extensions and Adapters By Type / Style

Please always confirm dimensions before ordering. Height Extensions and Adapters come in many different styles and dimensions. SVI is well-known as the adapter expert, specializing in top quality standard and custom adapters. SVI is your answer.

NS Nesting Style - FIXED Height Continued

2.135" (55 MM) PIN OD • 1-3/4" PIN LENGTH
For Challenger

Nesting Style Height Extensions for Challenger Lift Old 12000 Model

BH-7234-279 (Ref 12562) • 3" Extension
BH-7234-278 (Ref 12561) • 6" Extension

Type NS

2-1/4" PIN OD • 2-1/8" PIN LENGTH
For Benwil

3" Nesting Style Height Extension
GPOA8, GPOA9, GPOA10 Series

BH-7208-66-3

Type NS

2-3/8" PIN OD • 1-1/2" PIN LENGTH • EXTENSION HEIGHT VARIES (LISTED BELOW)
For Challenger Lifts, Ammco®, Launch, Magnum, Quality Lifts, Others - For Many Models

Nesting Style Height Extension

BH-7234-119 (Ref 10315) Height Extension Kit
(Kit Includes (4) 3" Tall, (2) 6" Tall, and (2) Hanging Brackets with Hardware)

BH-7234-119A (Ref B2206-3) 3" Extension Height
BH-7234-119B (Ref B2206-6, CLF10313) 6" Extension Height
BH-7234-119C (Ref B2209) Hanging Bracket
Included with Kit Pan Head Screws

Type NS

ALSO AVAILABLE—Not included in above kit. Sold Separately:
BH-7234-119D (Ref B2206-7) 7" Extension Height (Not Included In Kit Above)

2-3/8" (60MM) PIN OD • EXTENSION HEIGHT VARIES (LISTED BELOW)
For BendPak, and others - For Many Models

Nesting Style Height Extension

BH-7474-84 (Ref 5215757) 2" Extension Height (1)
BH-7474-84-4 (Ref 5215757) 2" Extension Height - Set of 4
BH-7474-85 (Ref 5215758, 5746192) 2-1/2" Extension Height (1)
BH-7474-85-4 (Ref 5215758, 5746192) 2-1/2" Extension Height - Set of 4
BH-7474-86 (Ref 5215759, 5746193) 4-7/8" Extension Height (1)
BH-7474-86-4 (Ref 5215759, 5746193) 4-7/8" Extension Height - Set of 4

Type NS

Height Extensions and Adapters By Type / Style

Please always confirm dimensions before ordering. Height Extensions and Adapters come in many different styles and dimensions. SVI is well-known as the adapter expert, specializing in top quality standard and custom adapters. SVI is your answer.

NS Nesting Style - FIXED Height Continued

2-3/4" PIN OD • 2-1/4" PIN LENGTH • EXTENSION HEIGHT VARIES (LISTED BELOW)

For Rotary Lifts - For Many Models

Nesting Style Height Extension - Aluminum

- BH-7536-53A 4" Extension Height
- BH-7536-53 (Ref FJ7822-4) 5" Extension Height
- BH-7536-53B 6" Extension Height
- BH-7536-55 (Ref FJ7822-6) 7-1/2" Extension Height
- BH-7536-54 (Ref FJ7822-5) 10" Extension Height

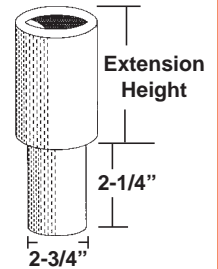

- BH-7536-52 (Ref FJ7822-3) Hanger Bracket Rack (without hardware)

2-3/4" PIN OD • EXTENSION HEIGHT VARIES (LISTED BELOW)

For Rotary Lifts - For Many Models

Nesting Style Height Extension

- BH-7548-028 (Ref FJ71013) 5" Extension Height
- BH-7548-029 (Ref FJ71014) 10" Extension Height

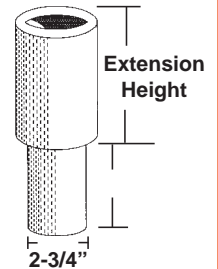

- BH-7536-52 (Ref FJ7822-3) Hanger Bracket Rack (without hardware)

3-1/8" PIN OD • 2-1/4" PIN LENGTH • EXTENSION HEIGHT VARIES (LISTED BELOW)

For Challenger Lifts, and others

Nesting Height Extensions 3-1/8" Diameter Pin

- BH-7234-210 (Ref B12069, 12069) 4" Height Extension
- BH-7234-208-5 (Ref 12062-12x) 5" Height Extension
- BH-7234-208-6 (Ref 12062-12x) 6" Height Extension
- BH-7234-211 (Ref 12068) 8" Height Extension

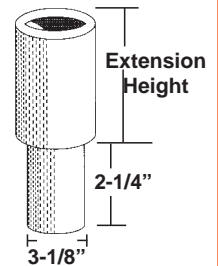

ALSO AVAILABLE

- BH-7234-211H (Ref 12071) Extension Holder Rack





Height Extensions and Adapters By Type / Style

Please always confirm dimensions before ordering. Height Extensions and Adapters come in many different styles and dimensions. SVI is well-known as the adapter expert, specializing in top quality standard and custom adapters. SVI is your answer.

NSP Nesting Style Adapter Pads - FIXED Pad Varies—Choose Your Style.

For Any Lift using Nesting Style Extensions and Adapters. Use with NS Height Extensions. Verify Pin Diameter and Pin Length used on the lift before ordering.



NSP
NESTING STYLE WITH PAD
See Type NS for Compatible Height Extensions.
Also see Alternative NSPSUA Spin-Up Adjustable Pad Adapters
Check Dimensions.

Possible Fitment by Pin OD—Always Confirm Dimensions on Lift:
1-1/8" Pin OD: For Mohawk, others
1-1/4" Pin OD: For Forward Lifts, others
1-3/8" (35mm) Pin OD: For BendPak, Magnum, Mohawk, Pro-Lift, others
1-1/2" Pin OD: For ALM, Ammco®, Ben Pearson, Rotary, others
2-3/8" (60mm) Pin OD: For BendPak, others

With Rectangle Pad:
Top Pad Dimensions:
4-7/8" x 3-7/8" x 7/8"



Type NSP



Replacement Pad: BH-7101-00



Standard Style
BH-7101-01C



Formed Style
BH-7101-01FC

FOR MANY MAKES / MODELS

Nesting Style Adapter Base and Replaceable Rectangle Rubber Pad BH-7101-00

1-1/8" PIN OD Pin Length Varies

BH-7340-11 (Ref 025-002-035x Alternative) 1-1/8" OD x 2-1/4" Long Pin (No Step)
 BH-7340-40 1-1/8" OD x 2-1/8" Long Pin (1-1/2" Step)

1-1/4" PIN OD X 1-1/8" LONG PIN

BH-7089-97R 1-1/4" OD x 1-1/8" Long Pin (1/2" Step)

1-1/4" PIN OD X 2-1/2" LONG PIN

BH-7796-10B (Ref 2-1993 Base, 2-1993x) 1-1/4" OD Pin x 2-1/2" Long (1/2" Step)
 BH-7796-10C (Ref 2-1993x) 1-1/4" OD Pin x 2-1/2" Long (1" Step) **Base ONLY**
 BH-7796-10T (Ref 2-1993x) 1-1/4" OD Pin x 2-1/2" Long (3" Step) **Base ONLY**
 BH-7796-10NS (Ref 2-1993x) 1-1/4" OD Pin x 2-1/2" Long (No Step) **Base ONLY**
 BH-7101-00-4 (Ref 5170105x) Rubber Pad Kit of 4 & Fasteners for Above Bases

1-3/8" (35MM) PIN OD X 1-13/16" LONG PIN

BH-7475-01R (Ref 5170105x) 1-3/8" (35mm) OD Pin x 1-13/16" Long (3/8" Step)
 BH-7475-01-4 (Ref 5170105x) Rubber Pad Kit of 4 & Fasteners for BH-7475-01R



(Ref 5170105)

◀ If you had this old rubber molded-on steel style, now order # BH-7475-01R.

1-1/2" PIN OD Pin Length Varies

BH-7101-01C (Ref 82591, 82361 - Base) 1-1/2" OD Pin x 1-13/16" Long (3/8" Step)
 BH-7101-01FC (Ref 82591, 82361 - Base) 1-1/2" OD Pin x 1-1/4" Long (No Step) - Formed

With Rectangle Pad:
Top Pad Dimensions:
5-1/4" x 4-1/4" x 1"



Type NSP

FOR MANY MAKES & MODELS INCLUDING WHEELTRONIC, AMMCO®*, BEN PEARSON, OTHERS

Nesting Style Adapter Base and Replaceable Rectangle Rubber Pad BH-7805-168

1-1/4" PIN OD X 2-1/2" LONG PIN

BH-7793-56 (Ref 1-3278) 1-1/4" OD Pin x 2-1/2" Long (No Step)
 BH-7796-10AP (Ref 2-1993x, 4S12634, 1-2634) 1-1/4" OD Pin x 2-1/2" Long (1/2" Step)
 BH-7796-10T (Ref 2-1993x) 1-1/4" OD Pin x 2-1/2" Long (3" Step) **Base ONLY**

Replacement Pad:
BH-7805-168



Height Extensions and Adapters By Type / Style

Please always confirm dimensions before ordering. Height Extensions and Adapters come in many different styles and dimensions. SVI is well-known as the adapter expert, specializing in top quality standard and custom adapters. SVI is your answer.

NSP Nesting Style Adapter Pads Continued

With Octagon Pad:
Top Dimensions:
5-1/2" Square with
Corners Turned Up



Type NSP

For those that prefer a thicker, longer lasting pad, see BH-7089-97R Series

FOR FORWARD AND MANY MAKES / MODELS

Nesting Style Adapter Base with Corners Turned Up and Replaceable Octagon Rubber Pad (Varies)

1-1/4" PIN OD X 1-3/16" LONG PIN
BH-7089-97 1-1/4" OD Pin x 1-3/16" Long (1/2" Step)

1-3/8" (35MM) PIN OD X 1-3/4" LONG PIN
BH-7089-97-13 1-3/8" OD Pin x 1-3/4" Long (1/2" Step)

1-1/2" PIN OD X 1-7/8" LONG PIN
BH-7089-97-15 1-1/2" OD Pin x 1-7/8" Long (1/2" Step)



Replacement Pad:
BH-7235-90A

With Slip-Over Round Pad:
Top Dimensions:
5" x 1" Round Pad



Type NSP

FOR BENDPAK AND MANY MAKES / MODELS

Nesting Style Adapter Base with Corners Turned Up and Replaceable Octagon Rubber Pad (Varies)

1-1/4" PIN OD X 1-3/16" LONG PIN
BH-7235-94RC 1-1/4" OD Pin x 1-3/16" Long

1-3/8" (35MM) PIN OD X 1-13/16" LONG PIN
BH-7474-79C (Ref 5215507x) 1-3/8" OD Pin x 1-13/16" Long
BH-7474-80C (Ref 5215507xx) 1-3/8" OD Pin x 1-13/16" Long (1-11/16" Taller)

2-3/8" (60MM) PIN OD
BH-7474-83 (Ref 5215760x) 2-3/8" (60mm) OD Pin (1)
BH-7474-83-4 (Ref 5215760x) 2-3/8" (60mm) OD Pin - Set of 4



Replacement Pad (1):
BH-7474-78



Uses Slip-Over Round Pad
Pad Sold Separately:
6-5/16" OD Pad



1-1/2"

Pad sold separately—See BH-7150-02

1-1/2" PIN OD X 2" LONG PIN

FOR ALM LIFTS

BH-7150-21 (Ref 07-4160A)
Drop-In Pickup Pad with 1-1/2" diameter pin
Pad Sold Separately.



Round Rubber Lift Pad (1)
BH-7150-02 (Ref A94208)
6-5/16" OD
Bottom Dimensions: 5-7/8" ID with Lip

Height Extensions and Adapters By Type / Style

Please always confirm dimensions before ordering. Height Extensions and Adapters come in many different styles and dimensions. SVI is well-known as the adapter expert, specializing in top quality standard and custom adapters. SVI is your answer.

NSP Nesting Style Adapter Pads Continued

1-1/4" PIN OD
 BH-7235-94
 Truck Adapter for
 Forward Lifts (No Pad)
 1-1/4" Pin OD x 1-3/16" Long

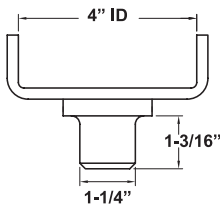

1-1/2" PIN OD
 BH-7235-95
 Truck Adapter for
 Hanmecson Lifts (No Pad)
 1-1/2" Pin OD x 1" Long

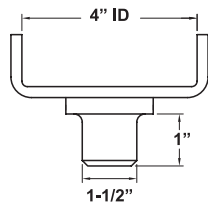

1-1/2" PIN ID
 Adapter with Octagon Pad
 (No Pin) for Whip Lifts
 Use with Double-Ended
 Nesting Height Extensions.



Replacement Pad: BH-7820-04

1-1/2" PIN OD
 BH-7270-078 (Ref 680030C, 30400-6005-1)
 Adapter Base Assembly with Round Pad 1/2" Step
 for Atlas, Direct, and Peak Lifts



Replacement Pad: BH-7588-465

1-1/2" PIN OD
 BH-7270-005 (Ref 30400-6005-2)
 Adapter Base Assembly with Round Pad - Tall Step
 for Atlas, Direct, and Peak Lifts

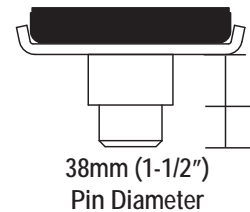

Rubber Pad Not Included BH-7588-465

1-3/8" (35MM) PIN OD
 Drop-In Nesting Style Adapter with Slip-Over Square Pad with
 1-3/8" Diameter Pin for Globe Lifts GV-10

BH-7256-20 Individual Adapter & Pad
 BH-7479-55 (Ref 5715365) Replacement Pad Only

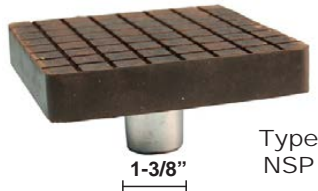

Type NSP

1-3/8" (35MM) PIN OD
 Drop-In Nesting Style Adapter with Slip-Over Square Pad with
 1-3/8" (35 mm) Diameter Pin for BendPak Lifts

BH-7475-28 (Ref 5210700) Individual Adapter & Pad
 BH-7479-55 (Ref 5715365) Replacement Pad Only

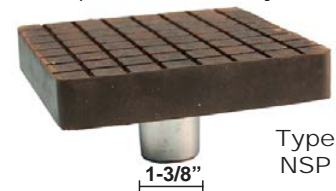

Type NSP

1-3/8" (35MM) PIN OD
 Frame Cradle Adapter Base & Square Rubber Pad
 with 1-3/8" (35 mm) Diameter Pin for BendPak Lifts

BH-7480-07 (Ref 17107022, 5215754) Adapter Base with Pad
 BH-7480-07-1 (Ref 17107021) Adapter Base Only
 BH-7256-20P (Ref 17108189) Replacement Pad Only

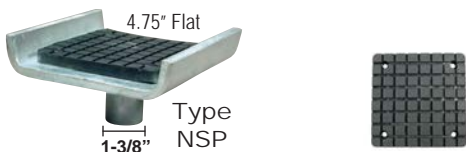

Type NSP

Also See BH-7472-30

1-3/8" (35MM) PIN OD
 Frame Cradle Adapter Base & Rectangle Rubber Pad
 with 1-3/8" (35 mm) Diameter Pin for BendPak Lifts

BH-7472-30 Adapter Base with Pad
 BH-7101-00 Replacement Pad Only

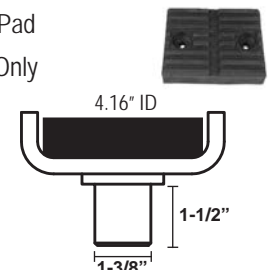

Type NSP

Also See BH-7480-07

Height Extensions and Adapters By Type / Style

Please always confirm dimensions before ordering. Height Extensions and Adapters come in many different styles and dimensions. SVI is well-known as the adapter expert, specializing in top quality standard and custom adapters. SVI is your answer.

NSP Nesting Style Adapter Pads Continued

1-3/8" PIN OD X 3-1/4" LONG PIN

Adapter with Rubber Pad - 1-3/8" Pin Diameter
For use with Mohawk LMF-12, TP15, others.

****Alternative Pad to Steel Teeth Pad (Ref 012-012-047x)**
Must buy 2 or 4 to change over.

- BH-7340-29 Adapter with Rubber Pad
- BH-7340-29P Rubber Arm Pad Only
4-1/2" x 6" x 3/8" Pad

Alternative to:
BH-7340-23 Steel Tooth Pad
(ref 012-012-047) Not Shown

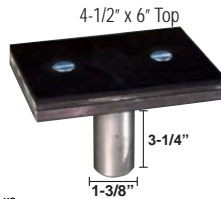

1-3/8" PIN OD X 3-3/4" LONG PIN

Adapter with Rubber Pad for Mohawk - 1-3/8" Pin Diameter
Must buy 2 or 4 to change over.

- BH-7340-26 Adapter with Rubber Pad
- BH-7340-26P Rubber Arm Pad Only
3" x 6" x 3/8" Pad



1.575" (40 MM) PIN OD

BH-7548-004 (Ref V12TP-4410)
Lift Pad Weldment 40mm (1.575") Pin Diameter
Octagon Rubber Pad Sold Separately



Type NSP



Sold Separately:
5" Octagon Pad (Ref 52200-3)
1/2" Thick Pad • Holes are 3.6" Apart
BH-7270-048 Individual Pad

Use with Pad BH-7270-048 or BH-7820-04

2-3/8" (60 MM) PIN OD

Frame Adapter with Pad 2-3/8" (60mm) OD x 1-3/8"
BH-7479-334 (Ref 5215702, 5174006)
For BendPak XPR-18C, XPR-10 Models and others

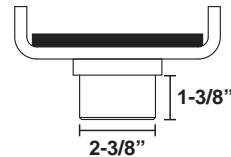

Replacement Pad: BH-7479-334P (ref 5715020)



5" x 5" Square

BH-7536-92X
Lift Adapter Base Assembly
without Rubber Pad 1-3/8" Pin
Ask for Kit with Pad

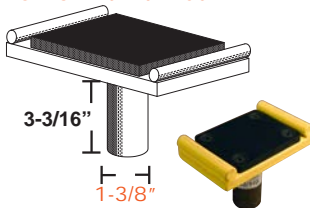

Use with Rubber Pad: BH-7536-92P
Pad Dimensions: 4-1/8" x 3-1/4"

BH-7536-92 (Ref FJ6158)
Lift Adapter Base Assembly
with Rubber Pad 1-1/2" Pin

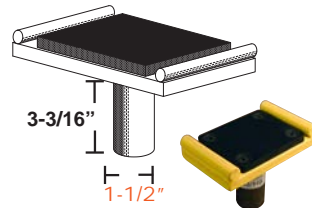

Replacement Rubber Pad: BH-7536-92P
Pad Dimensions: 4-1/8" x 3-1/4"

BH-9434-04 (Ref 060016C)
Complete Adapter Assembly
for Globe FSDT, others
1-1/2" Pin OD



Replacement Pad: BH-7205
Pad Dimensions: 4-1/8" x 3-1/2"

1-3/4" PIN OD • 1-3/16" LONG PIN
Nesting Style Steel Pad Adapter with
Round Rubber Pad for Nussbaum
(Ref 245SPL28217)

BH-7454-10 Adapter with Pad



Replacement Pad: BH-7450-02



Height Extensions and Adapters By Type / Style

Please always confirm dimensions before ordering. Height Extensions and Adapters come in many different styles and dimensions. SVI is well-known as the adapter expert, specializing in top quality standard and custom adapters. SVI is your answer.

NSPNRW Narrow Drop-In Nesting Style Height Extension Adapter - FIXED
 For Close-to-Frame Obstructions—Commonly sold for use on the rear of late model trucks. Avoids denting or puncturing fuel tank and smashing brake lines.

For Any Lift using Nesting Style Extensions and Adapters

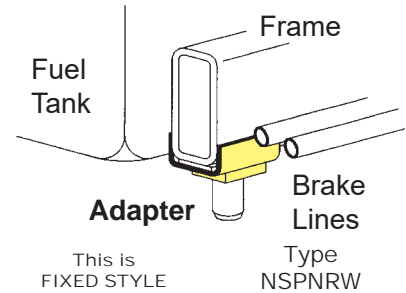

With Narrow Rectangle Pad:
 Top Dimensions:
 2-7/8" ID x 4-1/2"

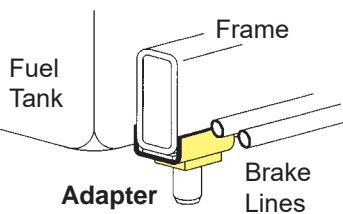

FOR MANY MAKES / MODELS
 Nesting Style Adapter Base with Corners Turned Up and Replaceable Octagon Rubber Pad (Varies)

- 1-1/8" PIN OD *Pin Length Varies*
- BH-7091-59 1-1/4" OD Pin x 1-7/8" Long
- BH-7091-60 1-1/4" OD Pin

- 1-1/4" PIN OD X 1-7/8" LONG PIN
- BH-7091-58 1-1/4" OD Pin x 1-7/8" Long

- 1-3/8" (35MM) PIN OD X 1-7/8" LONG PIN
- BH-7091-57 1-3/8" OD Pin x 1-7/8" Long

- 1-1/2" PIN OD X 2" LONG PIN
- BH-7091-56 1-1/2" OD Pin x 2" Long



Type NSPNRW

Height Extensions and Adapters By Type / Style

Please always confirm dimensions before ordering. Height Extensions and Adapters come in many different styles and dimensions. SVI is well-known as the adapter expert, specializing in top quality standard and custom adapters. SVI is your answer.

NSPSUA Drop-In Nesting Style Height Extension Adapter - **ADJUSTABLE** Height For Any Lift using Nesting Style Extensions and Adapters

With Rectangle Rubber Pad



Replacement Pad:
BH-7101-00

Heavy Duty

Adapter features a 5" x 4" rectangular top formed from heavy 3/16" and 3/8" steel plate with a replaceable rubber pad. Adapters adjust by simply turning the contact pad to the heights listed.



Type
NSPSUA
This is
ADJUSTABLE
STYLE

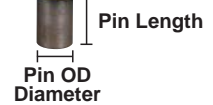

With Rectangle Pad:
Top Dimensions:
5" x 4"



This is
ADJUSTABLE
STYLE

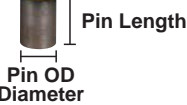

Type NSPSUA

FOR MANY MAKES / MODELS

Nesting Style Adapter Base with Corners Turned Up and Replaceable Octagon Rubber Pad (Varies)

1-3/8" (35MM) PIN OD X 3-1/8" LONG PIN • FOR MOHAWK, OTHERS
BH-7340-16 1-3/8" OD Pin x 1-7/8" Long

1-1/2" PIN OD X 2-1/2" LONG PIN

BH-7091-70 1-1/2" OD Pin x 2-1/2" Long • 5" to 6-3/4" Extension Height

BH-7091-71 1-1/2" OD Pin x 2-1/2" Long • 8" to 9-3/4" Extension Height

BH-7091-72 1-1/2" OD Pin x 2-1/2" Long • 10" to 12-3/4" Extension Height

Replacement Pad:
BH-7101-00





Height Extensions and Adapters By Type / Style

Please always confirm dimensions before ordering. Height Extensions and Adapters come in many different styles and dimensions. SVI is well-known as the adapter expert, specializing in top quality standard and custom adapters. SVI is your answer.

SUH5 Replacement Screw-Up Adapter - ADJUSTABLE

Any lift using threads 1-1/4"-7 or 1-3/8"-6 or 1-3/8"-4 ACME, lengths from 4" - 10"

Features Octagon Rubber Pad



- BH-7235-90A Individual Arm Pad
- BH-7235-90 Kit of 4 Pads and Fasteners

- Also works with Heavy Duty Pads:
- BH-7235-90AX Individual Arm Pad
 - BH-7235-90K Kit of 4 Pads and Fasteners



With Octagon Pad

5" Top or 5-1/2" Top



Type SUH5
Threads Vary.
See Options.

This is an ADJUSTABLE STYLE.

1-1/8"-7 THREADS • 5-1/2" SQUARE TOP WITH CORNERS TURNED UP

Spin-Up Height Extension with Octagon Rubber Pad
Features Replaceable Rubber Pad BH-7235-90A

5-1/2" SQUARE TOP

BH-7091-17 • 4" Adapter • 5-1/2" Top



5-1/2" Top
Type SUH5
Threads 1-1/8"-7

Replacement Rubber Pad: BH-7235-90A / BH-7235-90 (Kit) or Heavy Duty Version BH-7235-90AX / BH-7235-90K (Kit)

1-1/4"-7 THREADS • 5" SQUARE TOP WITH CORNERS TURNED UP

Spin-Up Height Extension with Octagon Rubber Pad
Features Replaceable Rubber Pad BH-7235-90A

- BH-7091-22 • 4" Adapter • 5" Top
- BH-7091-23 • 5" Adapter • 5" Top
- BH-7091-24 • 6" Adapter • 5" Top
- BH-7091-25 • 7" Adapter • 5" Top
- BH-7091-26 • 8" Adapter • 5" Top

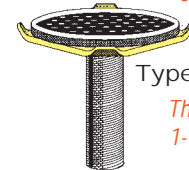

5" Top
Type SUH5
Threads 1-1/4"-7

Replacement Rubber Pad: BH-7235-90A / BH-7235-90 (Kit) or Heavy Duty Version BH-7235-90AX / BH-7235-90K (Kit)

1-3/8"-6 THREADS • 5" OR 5-1/2" SQUARE TOP WITH CORNERS TURNED UP

Spin-Up Height Extension with Octagon Rubber Pad
Features Replaceable Rubber Pad BH-7235-90A

5" SQUARE TOP

- BH-7091-27 • 4" Adapter • 5" Top
- BH-7091-28 • 5" Adapter • 5" Top
- BH-7091-29 • 6" Adapter • 5" Top
- BH-7091-30 • 7" Adapter • 5" Top
- BH-7091-31 • 8" Adapter • 5" Top

5" SQUARE TOP

- BH-7091-32 • 4" Adapter • 5-1/2" Top
- BH-7091-33 • 5" Adapter • 5-1/2" Top
- BH-7091-34 • 6" Adapter • 5-1/2" Top
- BH-7091-35 • 7" Adapter • 5-1/2" Top
- BH-7091-36 • 8" Adapter • 5-1/2" Top

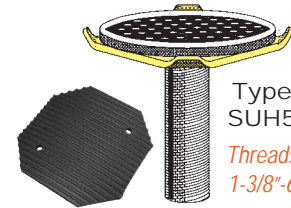

5" Top or 5-1/2" Top
Type SUH5
Threads 1-3/8"-6

Replacement Rubber Pad: BH-7235-90A / BH-7235-90 (Kit) or Heavy Duty Version BH-7235-90AX / BH-7235-90K (Kit)

1-1/2"-6 THREADS • 5" SQUARE TOP WITH CORNERS TURNED UP

Spin-Up Height Extension with Octagon Rubber Pad
Features Replaceable Rubber Pad BH-7235-90A

- BH-7091-80 • 5" Adapter • 5" Top
- BH-7091-81 • 6" Adapter • 5" Top
- BH-7091-82 • 7" Adapter • 5" Top
- BH-7091-83 • 8" Adapter • 5" Top
- BH-7091-84 • 9" Adapter • 5" Top
- BH-7091-85 • 10" Adapter • 5" Top

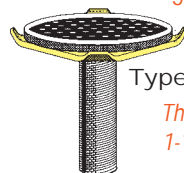

5" Top
Type SUH5
Threads 1-1/2"-6

Replacement Rubber Pad: BH-7235-90A / BH-7235-90 (Kit) or Heavy Duty Version BH-7235-90AX / BH-7235-90K (Kit)

1-3/4"-5 THREADS • 5-1/2" SQUARE TOP WITH CORNERS TURNED UP

Spin-Up Height Extension with Octagon Rubber Pad
Features Replaceable Rubber Pad BH-7235-90A

BH-7237-90 • 4" Adapter • 5" Top

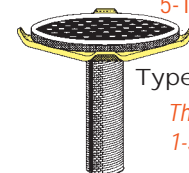

5-1/2" Top
Type SUH5
Threads 1-3/4"-5

Replacement Rubber Pad: BH-7235-90A / BH-7235-90 (Kit) or Heavy Duty Version BH-7235-90AX / BH-7235-90K (Kit)



Height Extensions and Adapters By Type / Style

Please always confirm dimensions before ordering. Height Extensions and Adapters come in many different styles and dimensions. SVI is well-known as the adapter expert, specializing in top quality standard and custom adapters. SVI is your answer.

SUH6 Replacement Screw-Up Adapter - ADJUSTABLE

Any lift using threads 1-1/4"-7 or 1-3/8"-6 or 1-3/8"-4 ACME, lengths from 4" - 10"

With Octagon Pad

Features Octagon Rubber Pad

- BH-7225-01 Individual Arm Pad
- BH-7225-01-4 Kit of 4 Pads and Fasteners

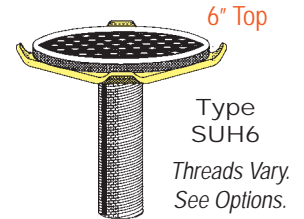

6" Top
Type SUH6
Threads Vary.
See Options.

This is an ADJUSTABLE STYLE.

1-1/4"-7 THREADS • 6" SQUARE TOP WITH CORNERS TURNED UP

Screw-Up Height Extension with Octagon Rubber Pad
Features Replaceable Rubber Pad BH-7225-01

Slip-Over Extensions Available!

- BH-7090-20 • 4" Adapter • 6" Top
- BH-7090-21 • 5" Adapter • 6" Top
- BH-7090-22 • 6" Adapter • 6" Top
- BH-7090-23 • 7" Adapter • 6" Top
- BH-7090-24 • 8" Adapter • 6" Top
- BH-7227-41 • 10" Adapter • 6" Top
- BH-7227-42 • 12" Adapter • 6" Top

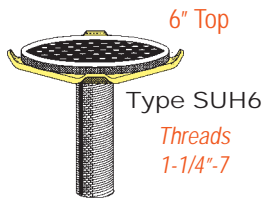

6" Top
Type SUH6
Threads 1-1/4"-7

Replacement Rubber Pad: BH-7235-90A / BH-7235-90 (Kit)
or Heavy Duty Version BH-7235-90AX / BH-7235-90K (Kit)

1-3/8"-6 THREADS • 6" SQUARE TOP WITH CORNERS TURNED UP

Screw-Up Height Extension with Octagon Rubber Pad
Features Replaceable Rubber Pad BH-7225-01

Slip-Over Extensions Available!

- BH-7225-03 • 3-1/2" Adapter • 6" Top • (Ref 31133, 4B31133)
- BH-7090-25 • 4" Adapter • 6" Top
- BH-7090-26 • 5" Adapter • 6" Top
- BH-7090-27 • 6" Adapter • 6" Top
- BH-7090-28 • 7" Adapter • 6" Top
- BH-7225-04 • 8" Adapter • 6" Top • (Ref 10062, 200083)
- BH-7090-30 • 9" Adapter • 6" Top
- BH-7090-31 • 10" Adapter • 6" Top



6" Top
Type SUH6
Threads 1-3/8"-6

Replacement Rubber Pad: BH-7235-90A / BH-7235-90 (Kit)
or Heavy Duty Version BH-7235-90AX / BH-7235-90K (Kit)

1-3/8"-4 ACME THREADS • 6" SQUARE TOP WITH CORNERS TURNED UP

Screw-Up Height Extension with Octagon Rubber Pad
Features Replaceable Rubber Pad BH-7225-01

Slip-Over Extensions Available!

- BH-7090-32 • 4" Adapter • 6" Top
- BH-7090-33 • 5" Adapter • 6" Top
- BH-7090-34 • 6" Adapter • 6" Top
- BH-7090-35 • 7" Adapter • 6" Top
- BH-7225-36 • 8" Adapter • 6" Top

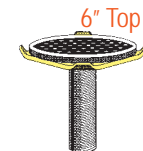

6" Top
Type SUH6
Threads 1-3/8"-4 ACME

Replacement Rubber Pad: BH-7235-90A / BH-7235-90 (Kit)
or Heavy Duty Version BH-7235-90AX / BH-7235-90K (Kit)



Height Extensions and Adapters By Type / Style

Please always confirm dimensions before ordering. Height Extensions and Adapters come in many different styles and dimensions. SVI is well-known as the adapter expert, specializing in top quality standard and custom adapters. SVI is your answer.

SUH 3-7/8" x 5" Replacement Screw-Up Adapter - ADJUSTABLE

Any lift using threads 1-3/8"-6, lengths from 4"-8". Identify thread size from the lift you are working on, determine length and select the part number for the items you would like us to ship. Also available for other threads, just ask!

Screw Up Height Extension with 3-7/8" x 5" Rectangle Top



- 1-3/8"-6 THREADS**
 BH-7091-86 • 4" Adapter
 BH-7091-87 • 5" Adapter
 BH-7091-88 • 6" Adapter
 BH-7091-89 • 7" Adapter
 BH-7091-90 • 8" Adapter

- 2"-4-1/2" UNC THREADS**
 BH-7150-97FRP • 3" Adapter



Features Rectangle Rubber Pad

- BH-7101-00 Individual Arm Pad
 BH-7101-00-4 Kit of 4 Pads and Fasteners

With Rectangle Pad
 3-7/8" x 5" Top



This is an ADJUSTABLE STYLE.

Type
 SUH3-7/8"x5"

SUNRW Narrow Screw-Up Adapter - ADJUSTABLE

For Close-to-Frame Obstructions—Commonly sold for use on the rear of late model trucks. Avoids denting or puncturing fuel tank and smashing brake lines.

Any lift using threads 1-1/8"-7, 1-1/4"-7, 1-3/8"-6, 1-3/8"-4 ACME, lengths from 4"-8". Identify thread size from the lift you are working on, determine length and select the part number for the items you would like us to ship.

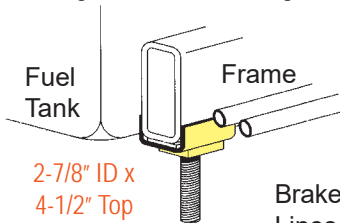

2-7/8" ID x
 4-1/2" Top

Brake
 Lines

Features Narrow Rectangle Rubber Pad
 BH-9755-50-1 Individual Arm Pad



With Narrow
 Rectangle Pad
 2-1/2" x 4-1/2" Top

This is an ADJUSTABLE STYLE.

Type
 SUNRW

1-1/8"-7 THREADS

Screw Up Height Extension for Close to Frame Obstructions

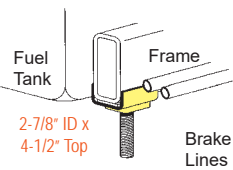

2-7/8" ID x
 4-1/2" Top

Brake
 Lines

Commonly sold for use on the rear of late model trucks. Avoids denting or puncturing fuel tank and smashing brake lines.

- BH-7091-48 • 4" Adapter
 BH-7091-49 • 6" Adapter

Type
 SUNRW

Features BH-9755-50-1 Rubber Pad



1-1/4"-7 THREADS

Screw Up Height Extension for Close to Frame Obstructions

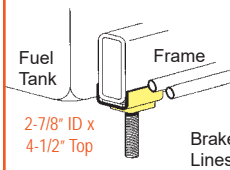

2-7/8" ID x
 4-1/2" Top

Brake
 Lines

Commonly sold for use on the rear of late model trucks. Avoids denting or puncturing fuel tank and smashing brake lines.

- BH-7091-45 • 4" Adapter
 BH-7091-46 • 6" Adapter
 BH-7091-47 • 8" Adapter

Type
 SUNRW

Features BH-9755-50-1 Rubber Pad



1-3/8"-6 THREADS

Screw Up Height Extension for Close to Frame Obstructions

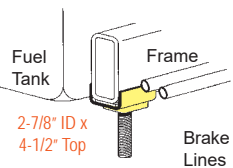

2-7/8" ID x
 4-1/2" Top

Brake
 Lines

Commonly sold for use on the rear of late model trucks. Avoids denting or puncturing fuel tank and smashing brake lines.

- BH-7091-37 • 4" Adapter
 BH-7091-38 • 6" Adapter
 BH-7091-39 • 8" Adapter
 BH-7091-40 • 10" Adapter

Type
 SUNRW

Features BH-9755-50-1 Rubber Pad



1-3/8"-4 ACME THREADS

Screw Up Height Extension for Close to Frame Obstructions

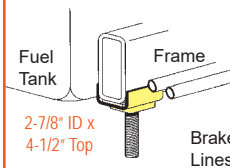

2-7/8" ID x
 4-1/2" Top

Brake
 Lines

Commonly sold for use on the rear of late model trucks. Avoids denting or puncturing fuel tank and smashing brake lines.

- BH-7091-41 • 4" Adapter
 BH-7091-42 • 6" Adapter
 BH-7091-43 • 8" Adapter
 BH-7091-44 • 10" Adapter

Type
 SUNRW

Features BH-9755-50-1 Rubber Pad





Height Extensions and Adapters By Type / Style

Please always confirm dimensions before ordering. Height Extensions and Adapters come in many different styles and dimensions. SVI is well-known as the adapter expert, specializing in top quality standard and custom adapters. SVI is your answer.

SUR5 Replacement Screw-Up Adapter - ADJUSTABLE

Any lift using 1-1/4"-7, 1-3/8"-6, or 1-3/8"-4 ACME Thread. Identify thread size from the lift you are working on, determine length and select the part number for the items you would like us to ship.

Features Bolt-On Approximately 5" Round Rubber Pad

Pad Diameter: 4-15/16"

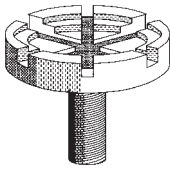

*Includes Replaceable Pad:
BH-7450-02 (Ref 10.157, 28335)*

With Bolt-On Round Pad

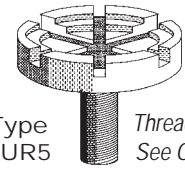

Type SUR5
Threads Vary. See Options.

This is an ADJUSTABLE STYLE.

1-1/4"-7 THREADS

Screw Up Adapter with Round Pad

- BH-7090-60 • 4" Adapter
- BH-7090-61 • 5" Adapter
- BH-7090-62 • 6" Adapter
- BH-7090-63 • 7" Adapter
- BH-7090-64 • 8" Adapter

Pad Diameter: 4-15/16"

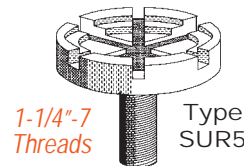

1-1/4"-7 Threads Type SUR5

Includes Replaceable Pad—See BH-7450-02

1-3/8"-6 THREADS

Screw Up Adapter with Round Pad

- BH-7090-65 • 4" Adapter
- BH-7090-66 • 5" Adapter
- BH-7090-67 • 6" Adapter
- BH-7090-68 • 7" Adapter
- BH-7090-69 • 8" Adapter
- BH-7090-70 • 9" Adapter
- BH-7090-71 • 10" Adapter

Pad Diameter: 4-15/16"

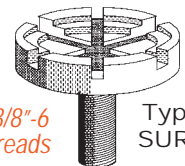

1-3/8"-6 Threads Type SUR5

Includes Replaceable Pad—See BH-7450-02

1-3/8"-4 ACME THREADS

Screw Up Adapter with Round Pad

- BH-7090-72 • 4" Adapter
- BH-7090-73 • 5" Adapter

Round Pad Diameter: 4-15/16"

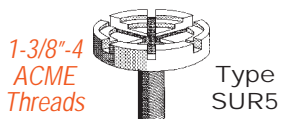

1-3/8"-4 ACME Threads Type SUR5

Replacement Pad: BH-7450-02



Height Extensions and Adapters By Type / Style

Please always confirm dimensions before ordering. Height Extensions and Adapters come in many different styles and dimensions. SVI is well-known as the adapter expert, specializing in top quality standard and custom adapters. SVI is your answer.

SUR6 Replacement Screw-Up Adapter - ADJUSTABLE

Any lift using 1-1/4"-7, 1-3/8"-6, 1-3/8"-4 Acme, or 1-1/2"-6 Thread. Identify thread size from the lift you are working on, determine length and select the part number for the items you would like us to ship.

Features Round Rubber Pad

Pad Diameter: 6-5/16"

Pad Height: 1-1/8"



Includes Replaceable Pad:
BH-7150-02 (ref A94208)

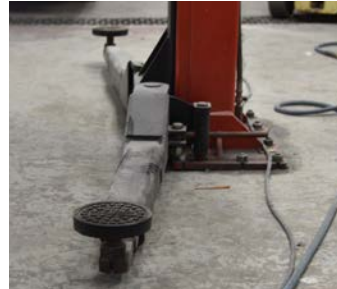

With Round Pad

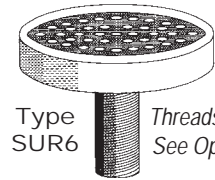

Type SUR6
Threads Vary.
See Options.

This is an ADJUSTABLE STYLE.

1-1/4"-7 THREADS

Screw Up Adapter with Pad

- BH-7090-40 • 4" Adapter
- BH-7090-41 • 5" Adapter
- BH-7090-42 • 6" Adapter
- BH-7090-43 • 7" Adapter
- BH-7090-44 • 8" Adapter

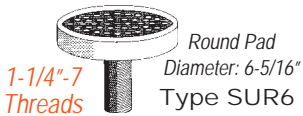

1-1/4"-7
Threads

Round Pad
Diameter: 6-5/16"
Type SUR6

Replacement Pad: BH-7150-02

1-3/8"-6 THREADS

Screw Up Adapter with Round Pad

- BH-7090-45 • 4" Adapter
- BH-7090-46 • 5" Adapter
- BH-7090-47 • 6" Adapter
- BH-7090-48 • 7" Adapter
- BH-7090-49 • 8" Adapter
- BH-7090-50 • 9" Adapter
- BH-7090-51 • 10" Adapter

Pad Diameter: 6-5/16"

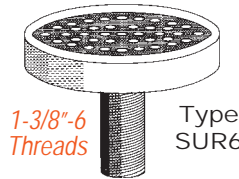

1-3/8"-6
Threads

Type
SUR6

Includes Replaceable Pad—See BH-7150-02

1-3/8"-4 ACME THREADS

Screw Up Adapter
with Round Pad

- BH-7090-52 • 4" Adapter
- BH-7090-53 • 5" Adapter

Round Pad Diameter: 6-5/16"

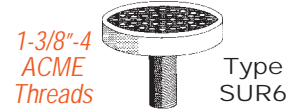

1-3/8"-4
ACME
Threads

Type
SUR6

Replacement Pad: BH-7150-02

1-1/2"-6 THREADS

Screw Up Adapter with Pad

- BH-7090-56 • 3" Adapter
- BH-7090-57 • 5" Adapter
- BH-7090-58 • 8" Adapter

Pad Diameter: 6-5/16"

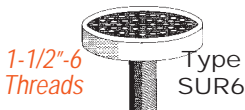

1-1/2"-6
Threads

Type
SUR6

Replacement Pad: BH-7150-02

Height Extensions and Adapters By Type / Style

Please always confirm dimensions before ordering. Height Extensions and Adapters come in many different styles and dimensions. SVI is well-known as the adapter expert, specializing in top quality standard and custom adapters. SVI is your answer.

SURX Replacement Screw-Up Adapter - ADJUSTABLE

Any lift using 1"-8, 1-1/4"-7, or 1-3/8"-6 Threads. Identify thread size from the lift you are working on, determine length and select the part number for the items you would like us to ship.

Features X-Pattern Slip-Over Rectangle Rubber Pad

Pad Diameter: 4" x 4-1/2"



*Includes Replaceable Pad:
BH-7750-02 (Ref S-350)*

*With X-Pattern
Rectangle Pad*



Type
SUR5

Threads Vary.
See Options.

This is an
ADJUSTABLE STYLE.

1"-8 THREADS

4" Screw Up Height
Extension with 4" x 4.5"
Rectangle Slip On Pad

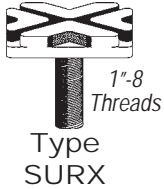

Type
SURX

Replaceable Pad: BH-7750-02

BH-7090-79
(Replaces
Ref S-351)



1-1/4"-7 THREADS

Screw Up Height Extension with 4" x 4.5" X-Pattern Rectangle
Slip Over Pad

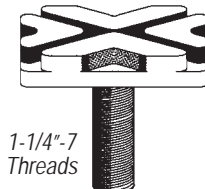

1-1/4"-7
Threads

Type
SURX

- BH-7090-80 • 4" Adapter
- BH-7090-81 • 5" Adapter
- BH-7090-82 • 6" Adapter
- BH-7090-83 • 7" Adapter
- BH-7090-84 • 8" Adapter



Features BH-7750-02 Rubber Pad

1-3/8"-6 THREADS

Screw Up Height Extension with 4" x 4.5" X-Pattern Rectangle
Slip Over Pad

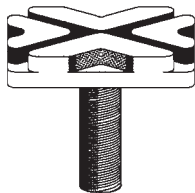

Type
SURX

- BH-7090-85 • 4" Adapter
- BH-7090-86 • 5" Adapter
- BH-7090-87 • 6" Adapter
- BH-7090-88 • 7" Adapter
- BH-7090-89 • 8" Adapter



Features BH-7750-02 Rubber Pad

Height Extensions and Adapters By Type / Style

Please always confirm dimensions before ordering. Height Extensions and Adapters come in many different styles and dimensions. SVI is well-known as the adapter expert, specializing in top quality standard and custom adapters. SVI is your answer.

Spin-Up and Telescoping Features Nut / Collar • Style Varies

1-1/2" NUT/COLLAR OD

2-Stage Adapter for SLR, SL210 with 1.5" OD Nut
For Rotary Lift RA Models with 3-Stage Trio Arms

BH-9784-82 (ref T100272) Adapter Kit (Set of 4) with Racks

BH-9784-81 (ref FJ6219) 1 Adapter Only

For
Rotary



1.57" (40 MM) NUT/COLLAR OD

Spin-Up Adapter (1) for Stenhoj • BH-7588-29
1.57" (40mm) Pin Diameter • Pin Length 1-1/8"



Replaceable Rubber Arm Pad: BH-7450-02

2" NUT/COLLAR OD

Pick Up Adapter Pad
Assembly with 2" Collar
BH-7209-99 (Ref 100946)



Replacement Pad: BH-7205

2" NUT/COLLAR OD

Steel Support & Adjustable Nut Adapter Pad Assembly with
2" Nut / Collar with Lip / 1-1/2"-4 Acme Screw
BH-7205-02RD

Kit Assembly Includes:

- BH-7205-02B (ref 00102500) Steel Support
- BH-7205-04A 2" OD Adjust Nut with 1-1/2"-4 Thread
- BH-7205 Rubber Arm Pad
- Pad Fasteners
- Roll Pin

For
Benwil



Replacement Pad: BH-7205
or Pad Kit: BH-7205-4

Looking for a custom adapter with anti-slip sides on the pad, contact SVI!

2" NUT/COLLAR OD

Adapter Base with Pad
7,000 and 9,000 lb. models
with 2-Stage Arms • 2" Pin OD
BH-7504-58
(Replaces FJ6159ZN, FJ6159)



2" NUT/COLLAR OD

Telescoping 2-Stage Round Thread Up Adapter with Pad
2" Pin OD • For Models SPOA7-RA, SPOA9-RA, SL210-RA, A8-RA, A10-RA, and SL210-RA
BH-7542-66 (Ref FJ6202)



Replaceable Pads: BH-7542-66PK (Kit of 4 Pads with Hardware)

These 2-stage spin-up adapters for use on RA Series Rotary lifts are American-Made and priced as you would expect from SVI. They are built at a quality level equal to or exceeding that of others on the market. Each appropriate piece is individually zinc plated before final assembly. The rubber pad is molded in North America using virgin material, for lifespan longevity; no regrinded material is used in the manufacturing process.

2-1/8" NUT/COLLAR OD

Complete Pad Assembly
For Challenger
Not Frame Engaging
BH-7232-67 (Ref 12563)



Replacement Pad—See BH-7101-00

2-1/4" NUT/COLLAR OD

Pick Up Adapter Pad
Assembly with 2-1/4" Collar
BH-7208-66B
(Ref 100965, 100967)



Replacement Pad: BH-7205



Height Extensions and Adapters By Type / Style

Please always confirm dimensions before ordering. Height Extensions and Adapters come in many different styles and dimensions. SVI is well-known as the adapter expert, specializing in top quality standard and custom adapters. SVI is your answer.

Spin-Up and Telescoping Features Nut / Collar • Style Varies Continued

2-3/8" NUT/COLLAR OD
BH-7232-98 (Ref B2260 / B2250)
Drop-In Adapter /
Foot Pad Assembly
with Round Rubber Pad

Works well with
BH-7234-119 (ref 10315)
Height Extension Kit

Replacement Pad: BH-7232-93



2-3/8" NUT/COLLAR OD
BH-7232-01UPB (Ref B2270)
Drop-In Adapter /
Foot Pad Assembly
with Urethane Pad

Works well with
BH-7234-119 (ref 10315)
Height Extension Kit

Replacement Pad: BH-7232-01U (Ref A1104H, Urethane) or BH-7232-01OHD (Rubber)



2-3/8" NUT/COLLAR OD
Telescopic / Spin-Up Round Lift Pad Adapter 60 mm
 Gives an extra 3" height clearance on 9,000 and 10,000 Lb Lifts
 (not for use on lifts with low profile arms)

Individual Adapter
BH-7474-79TP (Ref 5215704)
 Set of 4 Adapters
BH-7474-79TP-4 (Ref 5215762)

Replacement Slip-Over Pad: BH-7474-78



Standard Snap-In Urethane Pad (Ref A1104-H, A1104H)
 4-11/32" x 4" • 2 Snap-In Pegs On Bottom

BH-7232-01U 1 Pad—Sold Individually

The Better Choice—Does Not Curl Up like Urethane:
Heavy Duty Bolt-On Rubber Arm Pad ▶

An SVI Exclusive
BH-7232-01OHD 1 Pad
BH-7232-01OHD-4 Set of 4 Pads



3/8" Thick
 2-Ply

2.359" (60 MM)" NUT OD
Complete Pad Assembly
Not Frame Engaging

BH-7234-120 (Ref B12062-12)

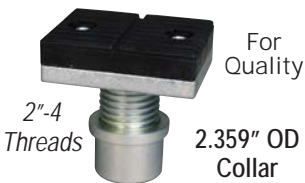

Replacement Pad—See BH-7101-00

2.359" (60 MM)" NUT OD
Complete Pad Assembly
Frame Engaging

BH-7234-128 (Ref B12162S-12)

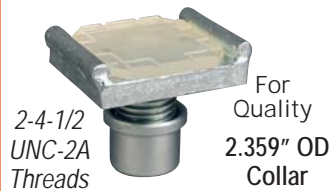

Replacement Pad—See BH-7232-01U

2-7/16" NUT/COLLAR OD
Steel Support & Adjustable Nut Adapter Pad Assembly with
2-7/16" Collar with Lip on Top / 1-1/2"-4 Acme Screw
BH-7205-02 (Ref 00102500, LAE000000)

Kit Assembly Includes:
BH-7205-02B (ref 00102500) Steel Support
BH-7205-04 (ref 11319950) Adjust Nut
BH-7205 Rubber Arm Pad
Pad Fasteners & Roll Pin

For Benwil



Replacement Pad: BH-7205 or Pad Kit: BH-7205-4

Looking for a custom adapter with anti-slip sides on the pad, contact SVI!

Screw-Up Telescoping Adapter with Pad
for Powerrex

BH-7560-123KIT • 1 Adapter

For Old-Style without Nut,
See BH-7560-05.

Use with Rubber Pad: BH-7560-04



Screw-Up Telescoping Truck Adapter with Pad
for Powerrex

BH-7560-124KIT • 1 Adapter

Use with Rubber Pad: BH-7101-00





Height Extensions and Adapters By Type / Style

Please always confirm dimensions before ordering. Height Extensions and Adapters come in many different styles and dimensions. SVI is well-known as the adapter expert, specializing in top quality standard and custom adapters. SVI is your answer.

Spin-Up and Telescoping Features Nut / Collar • Style Varies Continued

2-3/4" NUT/COLLAR OD
BH-7536-50 (Ref FJ7822-1)
Swing Arm Adapter Assembly

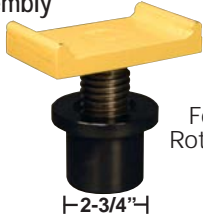

For Rotary

↳2-3/4"↳

Use with BH-7536-51 Rubber Adapter Pad (Ref FJ7822-2, FJ7822-2YL)

2-3/4" NUT/COLLAR OD
Screw Adapter and Base with 2-3/4" Collar / Nut OD
BH-7548-025 (Ref FJ71011)



For Rotary

↳2-3/4"↳

3-1/8" NUT/COLLAR OD
Complete Screw-Up Pad Adapter Assembly
Not Frame Engaging

BH-7234-208
 (Ref B12062, 12062-12)

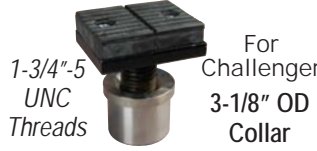

For Challenger
 3-1/8" OD Collar

1-3/4"-5 UNC Threads
 Replacement Pad—See BH-7101-00

3-1/8" NUT/COLLAR OD
Complete Screw-Up Pad Adapter Assembly
Frame Engaging

BH-7234-128-15 (Ref B12162S)



For Quality

2"-4-1/2 UNC Threads

3-1/8" OD Collar

Replacement Pad—See BH-7232-01U

Height Extensions and Adapters By Type / Style

Please always confirm dimensions before ordering. Height Extensions and Adapters come in many different styles and dimensions. SVI is well-known as the adapter expert, specializing in top quality standard and custom adapters. SVI is your answer.

GMT



- For ROTARY
- For CHALLENGER
- For BENDPAK
- For BENWIL
- For FORWARD
- For WHEELTRONIC
- For MOHAWK
- For GILBARCO
- For GLOBE
- For MANITOWOC LIFTS

For Any Make—Call Now!

All of SVI's GMT adapters use replaceable rubber pad BH-7542-75P

Specialty Lift Adapters FOR 2019, 2020 AND NEWER Chevrolet 1500 Silverado and GMC Sierra Truck Models



On-going SVI engineering and production activities are occurring to provide lifting adapters for many makes and models of lifts so the new 2019, 2020 and after GM Trucks can be correctly accommodated on virtually any lift. SVI employs a professional staff of engineers who are well-suited to design products to satisfy the requirements and internal self testing is also routinely performed, where applicable.



SPECIALTY | FOR SVI'S GMT STYLE ADAPTERS

Rectangle Rubber Arm Pad for SVI's GMT Style Specialty Wide Adapters for 2019, 2020 and newer Chevrolet 1500 Silverado and GM Sierra Trucks
These Adapters Feature 7" Wide Lifting Area—Available For Many Makes and Models

- BH-7542-75P 1 Pad Only
- BH-7542-75P-4 Kit of 4 Pads with Fasteners



6" x 3.25" x 3/8" Thick



1-1/4" PIN DIAMETER • 1-3/16" LONG PIN
Specialty Wide Adapter for 2019, 2020 and newer Chevrolet 1500 Silverado and GM Sierra Trucks
Features 7" Wide Lifting Area

- BH-7089-97GMT-1 (1) Adapter with 1-1/4" Pin & Pad
 - BH-7089-97GMT-2 Set of (2) Adapters with 1-1/4" Pin & Pad
- Features BH-7542-75P Rectangle Rubber Pad*



1-1/4 Pin Diameter





Height Extensions and Adapters By Type / Style

Please always confirm dimensions before ordering. Height Extensions and Adapters come in many different styles and dimensions. SVI is well-known as the adapter expert, specializing in top quality standard and custom adapters. SVI is your answer.

GMT Specialty Wide-Style Adapters for 2019+ GMC / Chevy Trucks TYPE GMT

7" Wide Lifting Area

IMPORTANT: Not all items pictured. Looking for something specific, or for a different make or model of lift? Let SVI know!

For Atlas Lifts

2" PIN DIAMETER • 2-3/16" LONG PIN
 Specialty Wide Adapter for 2019, 2020 and newer Chevrolet 1500 Silverado and GM Sierra Trucks - 2" Pin Diameter
 Features 7" Wide Lifting Area (Ref FJ6258, FJ6258KIT)

- BH-7542-75 (1) Adapter Base and Pad
- BH-7542-75K (2) Adapter Bases and Pads

Features BH-7542-75P Rectangle Rubber Pad

TYPE GMT
7" Wide Lifting Area



For BendPak Lifts

1-3/8" (35 MM) PIN DIAMETER • 1-13/16" LONG PIN
 Specialty Wide Adapter for 2019, 2020 and newer Chevrolet 1500 Silverado and GM Sierra Trucks - 1-3/8" (35 mm) Pin Dia.
 Features 7" Wide Lifting Area

- BH-7479-348GMT-1 (1) Adapter with 35mm Pin & Pad
- BH-7479-348GMT-2 (2) Adapters with 35mm Pin & Pad

Features BH-7542-75P Rectangle Rubber Pad

TYPE GMT
7" Wide Lifting Area



2-3/8" (60 MM) PIN DIAMETER • 1-13/16" LONG PIN
 Specialty Wide Adapter for 2019, 2020 and newer Chevrolet 1500 Silverado and GM Sierra Trucks - 2-3/8" (60 mm) Pin Dia.
 Features 7" Wide Lifting Area

- BH-7479-349GMT-1 (1) Adapter with 60mm Pin & Pad
- BH-7479-349GMT-2 (2) Adapters with 60mm Pin & Pad

Features BH-7542-75P Rectangle Rubber Pad

TYPE GMT
7" Wide Lifting Area



Height Extensions and Adapters By Type / Style

Please always confirm dimensions before ordering. Height Extensions and Adapters come in many different styles and dimensions. SVI is well-known as the adapter expert, specializing in top quality standard and custom adapters. SVI is your answer.

GMT Specialty Wide-Style Adapters for 2019+ GMC / Chevy Trucks Continued

TYPE GMT
7" Wide Lifting Area

IMPORTANT: Not all items pictured. Looking for something specific, or for a different make or model of lift? Let SVI know!

For Benwil and Bishamon Lifts

2" NUT / COLLAR OD • 2-1/4" LONG PIN

Specialty Wide Adapter for 2019, 2020 and newer Chevrolet 1500 Silverado and GM Sierra Trucks 2" Collar Diameter
Features 7" Wide Lifting Area (Ref 100946x)

- BH-7209-99GMT-1 (1) Adapter with 2" Collar & Pad
- BH-7209-99GMT-2 (2) Adapters with 2" Collar & Pad

Features BH-7542-75P Rectangle Rubber Pad

TYPE GMT
7" Wide Lifting Area



2" Collar Diameter

2-1/4" NUT / COLLAR OD • 2-1/8" LONG PIN

Specialty Wide Adapter for 2019, 2020 and newer Chevrolet 1500 Silverado and GM Sierra Trucks 2-1/4" Collar Diameter
Features 7" Wide Lifting Area (Ref 100965x)

- BH-7208-66GMT-1 (1) Adapter with 2-1/4" Collar & Pad
- BH-7208-66GMT-2 (2) Adapters with 2-1/4" Collar & Pad

Features BH-7542-75P Rectangle Rubber Pad

TYPE GMT
7" Wide Lifting Area



2-1/4" Collar Diameter

2-7/16" NUT / COLLAR OD • 1-5/16" LONG PIN

Specialty Wide Adapter for 2019, 2020 and newer Chevrolet 1500 Silverado and GM Sierra Trucks 2-7/16" Collar Diameter
Features 7" Wide Lifting Area (Ref 100946x)

- BH-7205-02GMT (1) Adapter with 2-7/16" Collar & Pad
- BH-7205-02GMT-2 (2) Adapters with 2-7/16" Collar & Pad

Features BH-7542-75P Rectangle Rubber Pad

TYPE GMT
7" Wide Lifting Area



1-1/2"-4 Screw with 2-7/16" Collar

Specialty Arm Receiver and Wide Adapter for Lifting 2019, 2020 and newer Chevrolet 1500 Silverado and GM Sierra Trucks
Features 7" Wide Lifting Area

- BH-7200-99 (1) Arm Receiver Only—Use with BH-7542-74
- BH-7542-74 (1) Adapters with Pad—Use with BH-7200-99

Features BH-7542-75P Rectangle Rubber Pad

TYPE GMT
7" Wide Lifting Area



BH-7542-74 Sold Separately

Arm Receiver BH-7200-99



Height Extensions and Adapters By Type / Style

Please always confirm dimensions before ordering. Height Extensions and Adapters come in many different styles and dimensions. SVI is well-known as the adapter expert, specializing in top quality standard and custom adapters. SVI is your answer.

GMT Specialty Wide-Style Adapters for 2019+ GMC / Chevy Trucks Continued

**TYPE
GMT**

7" Wide Lifting Area

IMPORTANT: Not all items pictured. Looking for something specific, or for a different make or model of lift? Let SVI know!

For Challenger Lifts

6-1/8" X 1" OPENING DIMENSIONS
 Specialty Wide Adapter for 2019, 2020 and newer Chevrolet 1500 Silverado and GM Sierra Trucks • 3" Slip On
 Features 7" Wide Lifting Area • SVI Exclusive

BH-7227-23GMT (1) 3" Slip On Height Extension

Features BH-7542-75P Rectangle Rubber Pad

**TYPE
GMT**

7" Wide Lifting Area

Fits over BH-7225-01 Rubber Pad

Opening Dimensions 6-1/8" x 1"

2-1/8" NUT / COLLAR OD • 1-3/4" LONG PIN
 Specialty Wide Adapter for 2019, 2020 and newer Chevrolet 1500 Silverado and GM Sierra Trucks - 2" Pin Diameter
 Features 7" Wide Lifting Area

BH-7231-47 (Ref B2280x) (1) Adapter Base and Pad
 BH-7231-47K (Ref B2280PRx) (2) Adapter Bases and Pads

Features BH-7542-75P Rectangle Rubber Pad

**TYPE
GMT**

7" Wide Lifting Area

Important: Confirm Dimensions

2-1/8" Nut Diameter

2-3/8" (60 MM) NUT / COLLAR OD • 1-3/5" LONG PIN
 Specialty Wide Adapter for 2019, 2020 and newer Chevrolet 1500 Silverado and GM Sierra Trucks - 2" Pin Diameter
 Features 7" Wide Lifting Area

BH-7232-98GMT-1 (Ref B2280x) (1) Adapter Base and Pad
 BH-7232-98GMT (Ref B2280PRx) (2) Adapter Bases and Pads

Features BH-7542-75P Rectangle Rubber Pad

**TYPE
GMT**

7" Wide Lifting Area

Important: Confirm Dimensions

2.358" Nut Diameter

1-3/8"-6 THREADS • SCREW-UP ADAPTER AND PAD
 Specialty Wide Adapter for 2019, 2020 and newer Chevrolet 1500 Silverado and GM Sierra Trucks 1-3/8"-6
 Features 7" Wide Lifting Area • SVI Exclusive

BH-7232-17GMT-1 (1) Screw Up Adapter with Pad
 BH-7232-17GMT (2) Screw Up Adapters with Pad

Features BH-7542-75P Rectangle Rubber Pad

**TYPE
GMT**

7" Wide Lifting Area

1-3/8"-6 Screw

3-1/8" NUT / COLLAR OD • 2-1/4" LONG PIN
 Specialty Wide Adapter for 2019, 2020 and newer Chevrolet 1500 Silverado and GM Sierra Trucks - Screw Up Adapter
 Features 7" Wide Lifting Area • SVI Exclusive

BH-7234-208GMT 12062-12x (1) Adapter with Pad

Features BH-7542-75P Rectangle Rubber Pad

**TYPE
GMT**

7" Wide Lifting Area

2"-4-1/2
UNC
Threads

3-1/8" OD
Collar

FOR OEM SPECIALTY ADAPTERS ONLY
 Specialty Urethane Snap-In Pad for OEM Version of Adapter for 2019, 2020 and newer Chevrolet 1500 Silverado and GM Sierra Trucks

BH-7232-98GMAP (Ref B2280-01) Replacement Pad (1)

Specialty Wide Style Snap-In Pad
for OEM Version Adapter for
New GM/Chevy Trucks

Approximately 6" x 3-1/2"

Height Extensions and Adapters By Type / Style

Please always confirm dimensions before ordering. Height Extensions and Adapters come in many different styles and dimensions. SVI is well-known as the adapter expert, specializing in top quality standard and custom adapters. SVI is your answer.

GMT Specialty Wide-Style Adapters for 2019+ GMC / Chevy Trucks Continued

IMPORTANT: Not all items pictured. Looking for something specific, or for a different make or model of lift? Let SVI know!

For Forward Lifts

1-3/4-5" THREADS • SCREW-UP ADAPTER AND PAD
 Specialty Wide Adapter for 2019, 2020 and newer Chevrolet 1500 Silverado and GM Sierra Trucks
 Features 7" Wide Lifting Area • SVI Exclusive

BH-7237-95GMT	5" Adapter Base and Pad (Set of 2)
BH-7237-95GMT-1	5" Adapter Base and Pad (1)
BH-7237-99GMT	9" Adapter Base and Pad (Set of 2)
BH-7237-99GMT-1	9" Adapter Base and Pad (1)

Features BH-7542-75P Rectangle Rubber Pad

FOR DPO15

BH-7237-95GMT
BH-7237-95GMT-1

BH-7237-99GMT
BH-7237-99GMT-1

For Gilbarco and Manitowoc Lifts

FITS OVER FLIP-UP ADAPTERS • OPENING DIMENSIONS 5-5/8" X 1-1/2"
 Specialty Wide Adapter for 2019, 2020 and newer Chevrolet 1500 Silverado and GM Sierra Trucks
 Features 7" Wide Lifting Area

BH-9380-10GMT	Flip-Up Adapter Height Extension Kit (Set of 4)
BH-9380-10GMT-1	Flip-Up Adapter Height Extension - FRONT
BH-9380-10GMT-2	Flip-Up Adapter Height Extension - FRONT (Set of 2)
BH-9380-10GMT-3	Flip-Up Adapter Height Extension - REAR
BH-9380-10GMT-4	Flip-Up Adapter Height Extension - REAR (Set of 2)

REAR FRONT

Opening Dimensions:
5-5/8" x 1-1/2"

For Globe Lifts

FITS OVER FLIP-UP ADAPTERS • OPENING DIMENSIONS 5-3/4" X 1-7/16"
 Specialty Wide Adapter for 2019, 2020 and newer Chevrolet 1500 Silverado and GM Sierra Trucks
 Features 7" Wide Lifting Area

BH-9420-13GMT	Flip-Up Adapter Height Extension Kit (Set of 4)
BH-9420-13GMT-1	Flip-Up Adapter Height Extension - FRONT
BH-9420-13GMT-2	Flip-Up Adapter Height Extension - FRONT (Set of 2)
BH-9420-13GMT-3	Flip-Up Adapter Height Extension - REAR
BH-9420-13GMT-4	Flip-Up Adapter Height Extension - REAR (Set of 2)

REAR FRONT

Opening Dimensions:
5-3/4" x 1-7/16"

Example Pic of Other GMT Adapters
(Not a Globe Lift Pictured)



Height Extensions and Adapters By Type / Style

Please always confirm dimensions before ordering. Height Extensions and Adapters come in many different styles and dimensions. SVI is well-known as the adapter expert, specializing in top quality standard and custom adapters. SVI is your answer.

GMT Specialty Wide-Style Adapters for 2019+ GMC / Chevy Trucks Continued



IMPORTANT: Not all items pictured. Looking for something specific, or for a different make or model of lift? Let SVI know!

For Mohawk Lifts

1-1/8" PIN DIAMETER • 2-1/4" LONG PIN
 Specialty Wide Adapter for 2019, 2020 and newer Chevrolet 1500 Silverado and GM Sierra Trucks - 1-1/8" (35 mm) Pin Dia.
 Features 7" Wide Lifting Area. 1-1/8" Pin dia. x 2-1/4" Long Pin
 BH-7341-58GMT-1 (1) Adapter Base with Pad
 BH-7341-58GMT Adapter Base with Pad (Set of 2)
 Features BH-7542-75P Rectangle Rubber Pad



Pin: 1-1/8" Dia. x 2-1/4" Long

1-3/8" (35 MM) PIN DIAMETER • 3-1/4" LONG PIN
 Specialty Wide Adapter for 2019, 2020 and newer Chevrolet 1500 Silverado and GM Sierra Trucks - 1-3/8" (35 mm) Pin Dia.
 For use with 12,000, 15,000, 16,000 lb. capacity 2-post lifts
 Features 7" Wide Lifting Area • 1-3/8" Pin Dia. x 3-1/4" Long Pin
 BH-7340-24GMT (ref 012-012-047) (1) Adapter Base with Pad
 Features BH-7542-75P Rectangle Rubber Pad



Pin: 1-3/8" Dia. x 3-1/4" Long

Height Extensions and Adapters By Type / Style

Please always confirm dimensions before ordering. Height Extensions and Adapters come in many different styles and dimensions. SVI is well-known as the adapter expert, specializing in top quality standard and custom adapters. SVI is your answer.

GMT Specialty Wide-Style Adapters for 2019+ GMC / Chevy Trucks Continued

IMPORTANT: Not all items pictured. Looking for something specific, or for a different make or model of lift? Let SVI know!

For Rotary Lifts

1-1/2" PIN DIAMETER • 1-1/2" LONG PIN
 Specialty Wide Adapter for 2019, 2020 and newer Chevrolet 1500 Silverado and GM Sierra Trucks - 1-1/2" Pin OD
 For TRIO Arms
 Features 7" Wide Lifting Area • (Ref FJ6257, FJ6257KIT)

BH-7542-74K (2) Adapters with 1-1/2" OD Pin & Pad
 BH-7542-74 (1) Adapter with 1-1/2" OD Pin & Pad
 Features BH-7542-75P Rectangle Rubber Pad



1-1/2" Pin OD 1-1/2" Pin Length

TYPE
GMT
 7" Wide Lifting Area

2" PIN DIAMETER • 2-3/16" LONG PIN
 Specialty Wide Adapter for 2019, 2020 and newer Chevrolet 1500 Silverado and GM Sierra Trucks - 2" Pin Diameter
 Features 7" Wide Lifting Area (Ref FJ6258, FJ6258KIT)

BH-7542-75 (1) Adapter Base and Pad
 BH-7542-75K (2) Adapter Bases and Pads
 Features BH-7542-75P Rectangle Rubber Pad



2" Pin Diameter 2-3/16" Pin Length

TYPE
GMT
 7" Wide Lifting Area

2" NUT / COLLAR OD • 2-5/16" LONG PIN
 Specialty Wide Adapter for 2019, 2020 and newer Chevrolet 1500 Silverado and GM Sierra Trucks - 2" Collar / Nut OD
 Features 7" Wide Lifting Area

BH-7542-76K4 (4) Adapters with 2" Collar & Pad
 BH-7542-76 (1) Adapter with 2" Collar & Pad
 Features BH-7542-75P Rectangle Rubber Pad



2" OD Collar
 1-1/2" Threads

TYPE
GMT
 7" Wide Lifting Area

2-3/4" NUT / COLLAR OD • 2-5/16" LONG PIN
 Specialty Wide Adapter for 2019, 2020 and newer Chevrolet 1500 Silverado and GM Sierra Trucks - 2-3/4" Collar / Nut OD
 Features 7" Wide Lifting Area • (Ref FJ7822-1x)

BH-7536-50GMT (2) Adapters with 2-3/4" Collar & Pad
 BH-7536-50GMT-1 (1) Adapter with 2-3/4" Collar & Pad
 Features BH-7542-75P Rectangle Rubber Pad



2-3/4" OD Collar

TYPE
GMT
 7" Wide Lifting Area

2-3/4" NUT / COLLAR OD • 2" LONG PIN
 Specialty Wide Adapter for 2019, 2020 and newer Chevrolet 1500 Silverado and GM Sierra Trucks - 2-3/4" Collar / Nut OD
 Features 7" Wide Lifting Area • (Ref FJ71011xx)

BH-7548-025GMT-2 (2) Adapters with 2-3/4" Collar & Pad
 BH-7548-025GMT-1 (1) Adapter with 2-3/4" Collar & Pad
 Features BH-7542-75P Rectangle Rubber Pad



2-3/4" Collar OD

TYPE
GMT
 7" Wide Lifting Area



Height Extensions and Adapters By Type / Style

Please always confirm dimensions before ordering. Height Extensions and Adapters come in many different styles and dimensions. SVI is well-known as the adapter expert, specializing in top quality standard and custom adapters. SVI is your answer.

GMT Specialty Wide-Style Adapters for 2019+ GMC / Chevy Trucks Continued

**TYPE
GMT**

7" Wide
Lifting Area

IMPORTANT: Not all items pictured. Looking for something specific, or for a different make or model of lift? Let SVI know!

For Rotary Lifts

FITS OVER FLIP-UP ADAPTERS • OPENING DIMENSIONS 4-5/8" X 1.61"

**TYPE
GMT**

7" Wide
Lifting Area

Specialty Lift Adapters

FOR 2019, 2020 AND NEWER



Chevrolet 1500 Silverado and GMC Sierra Truck Models



Adapter Kit
for Use over
Flip-Ups
BH-9755-50GMT
(ref FJ6259)

Front
BH-9755-50GMT-1
BH-9755-50GMT-2

Rear
BH-9755-50GMT-3
BH-9755-50GMT-4

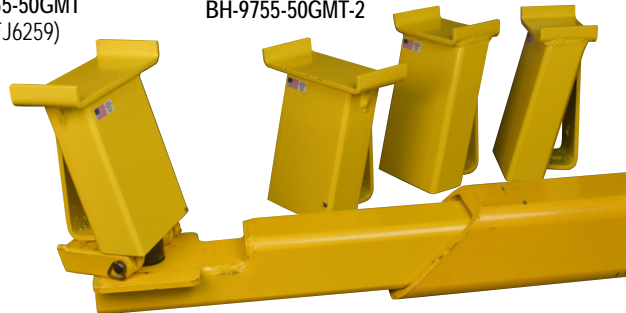

Front Adapters have 7" Wide Lifting Area



Inside Dimensions:
4-5/8" x 1.61"

On-going SVI engineering and production activities are occurring to provide lifting adapters for many makes and models of lifts so the new 2019, 2020 and after GM Trucks can be correctly accommodated on virtually any lift. SVI employs a professional staff of engineers who are well-suited to design products to satisfy the requirements and internal self testing is also routinely performed, where applicable.

FOR ANY ROTARY MODEL WITH FLIP-UP ADAPTERS

BH-9755-50GMT	FJ6259	Flip-Up Adapter Height Ext KIT (Set of 4)
	FJ6259KIT	Includes (2) Front / (2) Rear
BH-9755-50GMT-1	FJ6259x	Flip-Up Height Ext - Front
BH-9755-50GMT-2	FJ6259xx	Flip-Up Height Ext - Front (Set of 2)
BH-9755-50GMT-3	FJ6259xxx	Flip-Up Height Ext - Rear
BH-9755-50GMT-4	FJ6259xxx	Flip-Up Height Ext - Rear (Set of 2)
BH-9755-50H-GMT	FJ6114x	Hanger Brackets for BH-9755-50GMT

SOLD SEPARATELY:

BH-9755-50H-GMT (Ref FJ6114-x)
Specialty Wide-Style Hanger Brackets
(Set of 2) for BH-9755-50GMT

Each pair of brackets holds
(4) BH-9755-50GMT Series Adapters

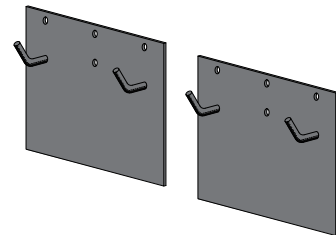

Have another type of lift? Call 800-321-8173 for GMT style adapters for any lift make.

Height Extensions and Adapters By Type / Style

Please always confirm dimensions before ordering. Height Extensions and Adapters come in many different styles and dimensions. SVI is well-known as the adapter expert, specializing in top quality standard and custom adapters. SVI is your answer.

GMT Specialty Wide-Style Adapters for 2019+ GMC / Chevy Trucks Continued



IMPORTANT: Not all items pictured. Looking for something specific, or for a different make or model of lift? Let SVI know!

For Wheeltronic Lifts

1-1/4" PIN DIAMETER • 2-1/2" LONG PIN

Specialty Wide Adapter for 2019, 2020 and newer Chevrolet 1500 Silverado and GM Sierra Trucks - 1-1/4" Pin Dia.

Features 7" Wide Lifting Area • Ref 2-1993x

BH-7796-10GMT (1) Adapter Base and Pad

BH-7796-10GMT-2 (2) Adapter Bases and Pads

Features BH-7542-75P Rectangle Rubber Pad



1-1/4" Pin Dia.

FITS OVER FLIP-UP ADAPTERS • OPENING DIMENSIONS 4-1/4" X 1-3/8"

Specialty Wide Adapter for 2019, 2020 and newer Chevrolet 1500 Silverado and GM Sierra Trucks

Features 7" Wide Lifting Area

BH-7798-19GMT Flip-Up Adapter Height Extension Kit (2 Front / 2 Rear)

BH-7798-19GMT-F (1) 7" Height Extension - FRONT

BH-7798-19GMT-R (1) 8" Height Extension - REAR

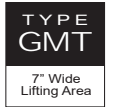



Height Extensions and Adapters For Alamo / ASSSA Lifts

Please always confirm dimensions before ordering. Height Extensions and Adapters come in many different styles and dimensions. SVI is well-known as the adapter expert, specializing in top quality standard and custom adapters. SVI is your answer.



MANY MORE AVAILABLE!
 See *common adapters and pads at the beginning of this catalog:*
 Height Extensions & Adapters By Type / Style
 Includes Nesting Style Height Extensions, Nesting Pad Adapters,
 Slip-On Style, Drop-On Style, Adjustable and Fixed Adapters, and more!



Additional Height Extensions for Alamo / ASSSA Lifts FOR VARIOUS MODELS

<p>Rubber Lift Pad for Alamo ASSSA Lifts BH-7165-02 Individual Pad (1)</p> <div style="display: flex; align-items: center;">   </div>	<p>BH-7165-10 4"–6" Adjustable Height Extension with Octagon Pad Fits over BH-7165-02 Pad</p> <div style="text-align: center;"> <p>Type ALDH</p>  </div> <p>Opening Dimensions: 4-1/8" x 3/4"</p> <p>Replacement Pad—See BH-7235-90A</p>	<p>BH-7165-11 6"–9-1/2" Adjustable Height Extension with Octagon Pad Fits over BH-7165-02 Pad</p> <div style="text-align: center;"> <p>Type ALDH</p>  </div> <p>Opening Dimensions: 4-1/8" x 3/4"</p> <p>Replacement Pad—See BH-7235-90A</p>
---	---	--

More Styles Available—See common "Height Extensions & Adapters By Type / Style" at the beginning of this catalog!

Height Extensions and Adapters For ALM Lifts

Please always confirm dimensions before ordering. Height Extensions and Adapters come in many different styles and dimensions. SVI is well-known as the adapter expert, specializing in top quality standard and custom adapters. SVI is your answer.

MANY MORE AVAILABLE!
See common adapters and pads at the beginning of this catalog:
Height Extensions & Adapters By Type / Style
Includes Nesting Style Height Extensions, Nesting Pad Adapters,
Slip-On Style, Drop-On Style, Adjustable and Fixed Adapters, and more!

Additional Height Extensions for ALM Lifts FOR VARIOUS MODELS

<p>FOR ALM BH-7150-02 (Ref A94208) Rubber Lift Pad (1) - Round <i>Sold Individually</i></p> <div style="text-align: center;"> <p>6-5/16" OD Bottom Dimensions: 5-7/8" ID with Lip</p> </div>	<p>1-3/8"-6 THREADS Screw Up Adapter with Round Pad</p> <p>BH-7090-45 • 4" Adapter BH-7090-46 • 5" Adapter BH-7090-47 • 6" Adapter BH-7090-48 • 7" Adapter BH-7090-49 • 8" Adapter BH-7090-50 • 9" Adapter BH-7090-51 • 10" Adapter</p> <div style="text-align: center;"> <p>Pad Diameter: 6-5/16" 1-3/8"-6 Threads Type SUR6</p> <p><i>Includes Replaceable Pad—See BH-7150-02</i></p> </div>	<p>1-3/8"-6 THREADS BH-7154-07 (Ref 94-209A) Lift Pad Assembly Threaded 1-3/8"-6 Top Diameter: 5.95"</p> <div style="text-align: center;"> <p>1-3/8"-6 Threads</p> <p><i>This does not include Rubber Pad.</i></p> </div>
<p>1-3/8"-6 THREADS BH-7150-93 (Ref 15-4027A) 10" Height Extension 1-3/8"-6 Threads</p> <div style="text-align: center;"> <p>Please Confirm Threads 1-3/8"-6 Threads</p> </div>	<p>2"-4.5 UNC 2A THREADS BH-7150-97 (Ref 15-4031A) Arm Adapter - Standard <i>Please Confirm Threads</i></p> <div style="text-align: center;"> <p>4.25" ID 2"-4.5 UNC 2A Thread</p> <p><i>Also see BH-7150-97FRP</i></p> </div>	<p>2"-4.5 UNC 2A THREADS BH-7150-97FRP (Ref 15-4031Ax) Flat Adapter Assembly with Rubber Pad For ALM 15,000 Lb Lift <i>Please Confirm Threads</i></p> <div style="text-align: center;"> <p>With Rectangle Pad 3-7/8" x 5" Top</p> <p>Features Rectangle Rubber Pad BH-7101-00 2"-4.5 UNC 2A Thread</p> </div>
<p>1-1/2" PIN OD X 2" LONG PIN BH-7150-21 (Ref 07-4160A) Drop-In Pickup Pad with 1-1/2" Diameter Pin for ALM Lifts <i>Pad Sold Separately.</i></p> <div style="text-align: center;"> <p>1-1/2"</p> <p><i>Pad sold separately—See BH-7150-02</i></p> </div>	<p><i>Uses Slip-Over Round Pad Pad Sold Separately: 6-5/16" OD Pad</i></p> <div style="text-align: center;"> </div>	<p>6-1/2" X 1-5/16" OPENING DIMENSIONS Fixed Slip-On Height Extension with Round Pad <i>Fits over BH-7150-02 Round Pad</i></p> <p>BH-7150-22 • 3" Extension BH-7150-23 • 4" Extension BH-7150-24 • 5" Extension BH-7150-03 • 6" Extension BH-7150-25 • 7" Extension BH-7150-26 • 8" Extension BH-7150-04 • 9" Extension BH-7150-27 • 10" Extension</p> <div style="text-align: center;"> <p>Type ARND Opening Dimensions: 6-1/2" x 1-5/16"</p> <p><i>Includes Replaceable Pad—See BH-7150-02</i></p> </div>



Height Extensions and Adapters For ALM Lifts

Please always confirm dimensions before ordering. Height Extensions and Adapters come in many different styles and dimensions. SVI is well-known as the adapter expert, specializing in top quality standard and custom adapters. SVI is your answer.





MANY MORE AVAILABLE!

See common adapters and pads at the beginning of this catalog:
 Height Extensions & Adapters By Type / Style
 Includes Nesting Style Height Extensions, Nesting Pad Adapters,
 Slip-On Style, Drop-On Style, Adjustable and Fixed Adapters, and more!

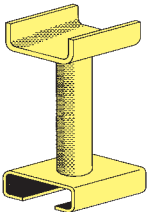

Additional Height Extensions for ALM Lifts FOR VARIOUS MODELS

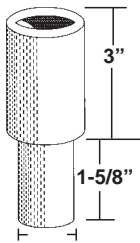
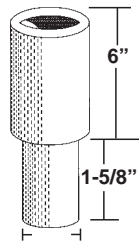
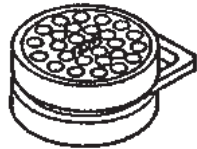
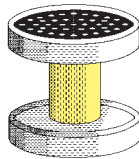
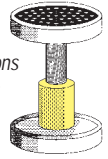
<p>6-9/16" X 1-15/32" OPENING DIMENSIONS BH-7152-35 (Ref 94-006A) 9" Slip-On Fixed Height Extension</p>  <p><i>Opening Dimensions: 6-9/16" x 1-15/32"</i></p>	<p>BH-7156-75 (Ref 12-5146A) Lift Pad Assembly</p> 	<p>BH-7156-76 (Ref 12-5145-02) 3" Nesting Height Extension 4-5/8" OAL</p> 	<p>BH-7156-77 (Ref 12-5145-03) Extension Pin 7-5/8" x 6"</p> 
<p>BH-7156-15 (Ref E061225A) Lift Pad Assembly Features (2) Replaceable Round Rubber Pads BH-7150-02</p>  <p><i>Also see BH-7091-10 Series.</i> <i>Replacement Pad—See BH-7150-02</i></p>	<p>Height Extension - Specialty Features (2) Replaceable Round Rubber Pads BH-7150-02</p> <p>BH-7091-10 • 3" Adapter BH-7091-11 • 4" Adapter BH-7091-12 • 5" Adapter BH-7091-13 • 6" Adapter BH-7091-14 • 7" Adapter</p>  <p style="text-align: center;">Pad Dimensions 6-5/16" OD Type LRPR</p>		<p>Adjustable Height Extension Specialty Features Replaceable Round Rubber Pads (2) BH-7150-02</p> <p>BH-7091-15 • 4" to 6" Adj. BH-7091-16 • 5" to 8" Adj.</p>  <p style="text-align: center;">Pad Dimensions 6-5/16" OD Type ALRPR</p>



Height Extensions and Adapters For Ammco®* Lifts

Please always confirm dimensions before ordering. Height Extensions and Adapters come in many different styles and dimensions. SVI is well-known as the adapter expert, specializing in top quality standard and custom adapters. SVI is your answer.









MANY MORE AVAILABLE!
See common adapters and pads at the beginning of this catalog:
Height Extensions & Adapters By Type / Style
Includes Nesting Style Height Extensions, Nesting Pad Adapters,
Slip-On Style, Drop-On Style, Adjustable and Fixed Adapters, and more!

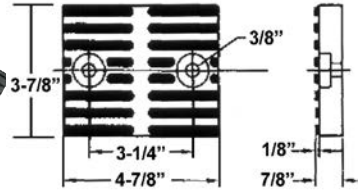

Additional Height Extensions for Ammco®* Lifts FOR VARIOUS MODELS

<p>1-1/2" PIN OD BH-7101-01C (Ref 82591, 82361 - Base) Adapter Base and Pad</p> <div style="text-align: center;">  </div> <p style="text-align: center; font-size: small;">Replacement Pad: BH-7101-00</p>	<p>1-1/2" PIN OD BH-7101-01FC Adapter Base & Pad Assembly Replacement Pad: BH-7101-00 Also See BH-7101-01C</p> <div style="text-align: center;">  </div> <p style="text-align: center; font-size: small;">Also: BH-7101-01F (Ref 82361) Adapter <u>Base Only</u> - Formed 1-1/2" Diameter Pin (No Pad)</p>	<p>FOR AMMCO®*, BEN PEARSON, CHALLENGER, MANY Rectangle Rubber Arm Pad (Replaces Ref 82365, 10-0017, 482365, 91559, 37008, others) BH-7101-00 • 1 Pad BH-7101-00-4 • Kit of 4 Pads</p> <div style="display: flex; align-items: center;"> <div style="margin-right: 20px;">  </div> <div>  </div> </div>																
<p>1-1/2" PIN OD • 2" PIN LENGTH • EXTENSION HEIGHT VARIES (LISTED BELOW) For ALM, Ammco®* Lifts, Ben Pearson, Challenger Lifts, Rotary Lifts, and others Nesting Style Height Extension</p> <table style="width: 100%; border: none;"> <tr> <td style="width: 30%;">BH-7101-02 (Ref 81693, 27984, 91560)</td> <td>2-5/8" Extension Height</td> </tr> <tr> <td>BH-7090-14</td> <td>3" Extension Height</td> </tr> <tr> <td>BH-7101-04 (Ref 81692)</td> <td>3-1/2" Extension Height</td> </tr> <tr> <td>BH-7090-15</td> <td>4" Extension Height</td> </tr> <tr> <td>BH-7101-03 (Ref 81691, 27982, 91562)</td> <td>5" Extension Height</td> </tr> <tr> <td>BH-7090-16</td> <td>6" Extension Height</td> </tr> <tr> <td>BH-7090-17</td> <td>7" Extension Height</td> </tr> <tr> <td>BH-7500-95 (Ref FJ6145)</td> <td>Hanger Bracket Rack (without hardware)</td> </tr> </table>			BH-7101-02 (Ref 81693, 27984, 91560)	2-5/8" Extension Height	BH-7090-14	3" Extension Height	BH-7101-04 (Ref 81692)	3-1/2" Extension Height	BH-7090-15	4" Extension Height	BH-7101-03 (Ref 81691, 27982, 91562)	5" Extension Height	BH-7090-16	6" Extension Height	BH-7090-17	7" Extension Height	BH-7500-95 (Ref FJ6145)	Hanger Bracket Rack (without hardware)
BH-7101-02 (Ref 81693, 27984, 91560)	2-5/8" Extension Height																	
BH-7090-14	3" Extension Height																	
BH-7101-04 (Ref 81692)	3-1/2" Extension Height																	
BH-7090-15	4" Extension Height																	
BH-7101-03 (Ref 81691, 27982, 91562)	5" Extension Height																	
BH-7090-16	6" Extension Height																	
BH-7090-17	7" Extension Height																	
BH-7500-95 (Ref FJ6145)	Hanger Bracket Rack (without hardware)																	
		<div style="display: flex; align-items: center;"> <div style="margin-right: 20px;">  </div> <div>  <p style="text-align: center;">Type NS</p> </div> </div>																



Height Extensions and Adapters For Atlas Lifts

Please always confirm dimensions before ordering. Height Extensions and Adapters come in many different styles and dimensions. SVI is well-known as the adapter expert, specializing in top quality standard and custom adapters. SVI is your answer.



MANY MORE AVAILABLE!
 See common adapters and pads at the beginning of this catalog:
 Height Extensions & Adapters By Type / Style
 Includes Nesting Style Height Extensions, Nesting Pad Adapters,
 Slip-On Style, Drop-On Style, Adjustable and Fixed Adapters, and more!



Additional Height Extensions for Atlas Lifts FOR VARIOUS MODELS

FOR ATLAS, PEAK, MORE
Rubber Lift Pad - Round
 (Ref 209134, ATPKP-LP-CIR)

BH-7588-465 1 Pad

0.83" Thick



Please Confirm Dimensions 4-3/4" OD
 9/32" Center Hole

BH-7166-245
 (Ref 201046A, 226391)
Adapter and Pad Assembly

IMAGE
 COMING
 SOON

BH-7270-078
 (Ref 680030C, 30400-6005-1)
Adapter Base Assembly with Round Pad 1/2" Step



38mm (1-1/2") Pin Diameter

Also See BH-7270-078
 Replacement Pad: BH-7588-465

BH-7270-005
 (Ref 30400-6005-2)
Adapter Base Assembly with Round Pad - Tall Step

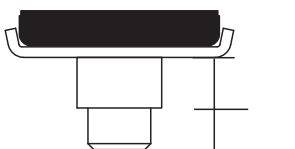

38mm (1-1/2") Pin Diameter

Rubber Pad Not Included BH-7588-465

High and Low Flip-Up Adapter (1) Accessory for APEX-10
BH-7165-44 (Ref Z23A611000)



Gives Ability to use Rotary-Style Adapters with Atlas APEX-10

4-1/2" (114mm) Nesting Height Extension
BH-7166-047 (Ref Z23G600101)

Type NS

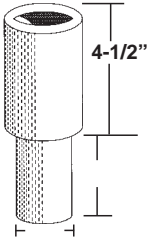

8-1/2" (216mm) Nesting Height Extension
BH-7166-046 (Ref Z23G600102)

Type NS

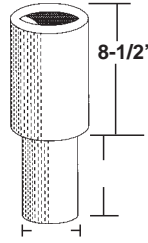

BH-7166-260 (Ref 209052B)
2-1/2" (63mm) Nesting Height Extension

Type NS

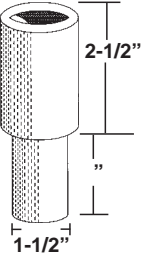

BH-7166-261 (Ref 209053B)
5" (127mm) Nesting Height Extension

Type NS

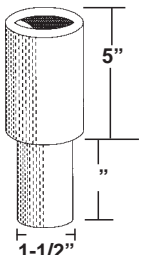



Height Extensions and Adapters For Ben Pearson Lifts

Please always confirm dimensions before ordering. Height Extensions and Adapters come in many different styles and dimensions. SVI is well-known as the adapter expert, specializing in top quality standard and custom adapters. SVI is your answer.





MANY MORE AVAILABLE!
See common adapters and pads at the beginning of this catalog:
Height Extensions & Adapters By Type / Style
Includes Nesting Style Height Extensions, Nesting Pad Adapters,
Slip-On Style, Drop-On Style, Adjustable and Fixed Adapters, and more!



Additional Height Extensions for Ben Pearson Lifts FOR VARIOUS MODELS

1-1/2" PIN OD
BH-7101-01C
(Ref 82591, 82361 - Base)
Adapter Base and Pad



Replacement Pad: BH-7101-00

1-1/2" PIN OD
BH-7101-01FC Adapter Base & Pad Assembly
Replacement Pad: BH-7101-00
Also See BH-7101-01C



Also: BH-7101-01F (Ref 82361)
Adapter Base Only - Formed
1-1/2" Diameter Pin (No Pad)

FOR AMMCO®*, BEN PEARSON, CHALLENGER, MANY

Rectangle Rubber Arm Pad
(Replaces Ref 82365, 10-0017, 482365, 91559, 37008, others)
BH-7101-00 • 1 Pad
BH-7101-00-4 • Kit of 4 Pads



1-1/2" PIN OD • 2" PIN LENGTH • EXTENSION HEIGHT VARIES (LISTED BELOW)
For ALM, Ammco®* Lifts, Ben Pearson, Challenger Lifts, Rotary Lifts, and others
Nesting Style Height Extension

BH-7101-02 (Ref 81693, 27984, 91560)	2-5/8" Extension Height	
BH-7090-14	3" Extension Height	
BH-7101-04 (Ref 81692)	3-1/2" Extension Height	
BH-7090-15	4" Extension Height	
BH-7101-03 (Ref 81691, 27982, 91562)	5" Extension Height	
BH-7090-16	6" Extension Height	
BH-7090-17	7" Extension Height	
BH-7500-95 (Ref FJ6145)	Hanger Bracket Rack <i>(without hardware)</i>	

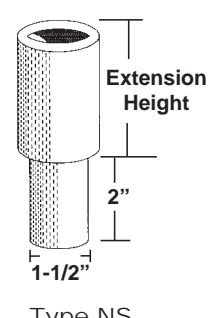

Type NS



Height Extensions and Adapters For BendPak Lifts

Please always confirm dimensions before ordering. Height Extensions and Adapters come in many different styles and dimensions. SVI is well-known as the adapter expert, specializing in top quality standard and custom adapters. SVI is your answer.



MANY MORE AVAILABLE!

See common adapters and pads at the beginning of this catalog:
 Height Extensions & Adapters By Type / Style
 Includes Nesting Style Height Extensions, Nesting Pad Adapters,
 Slip-On Style, Drop-On Style, Adjustable and Fixed Adapters, and more!



Additional Height Extensions for BendPak Lifts FOR ROLLING BRIDGE JACKS

Adjust-A-Spot
 9" Extension Kit for BendPak Rolling Jacks
 RBJ4500 / RJ-45, RJ45W
 Includes 2 Extensions with Pins
 BH-7474-81



New and Improved!
 Contact SVI Today!

Adjust-A-Spot
 9" Extension Kit for BendPak Rolling Jacks RBJ7000
 Includes 2 Extensions with Pins
 BH-7474-82



New and Improved!
 Contact SVI Today!

(Note: BH-7474-81 Pictured)

Additional Height Extensions for BendPak Lifts FOR VARIOUS MODELS

1-3/8" (35MM) PIN OD
 Drop-In Nesting Style Adapter with Slip-Over Square Pad with
 1-3/8" (35 mm) Diameter Pin for BendPak Lifts

BH-7475-28 (Ref 5210700) Individual Adapter & Pad
 BH-7479-55 (Ref 5715365) Replacement Pad Only



Type
NSP

1-3/8" (35MM) PIN OD
 Round Lift Pad Adapter with 1-3/8" (35 mm) Pin (Ref 5215507)

BH-7474-79C Adapter and Pad
 BH-7474-79 Adapter Only (without pad)
 BH-7474-80C Adapter and Pad - 1-11/16" Taller
 BH-7474-80 Adapter Only - 1-11/16" Taller
 BH-7474-78 Replacement Pad Only



Type
NSP

1-3/8" (35MM) PIN OD Type
NSP

Frame Cradle Adapter Base & Rectangle Rubber Pad
 with 1-3/8" (35 mm) Diameter Pin for BendPak Lifts

BH-7472-30 Adapter Base with Pad
 BH-7101-00 Replacement Pad Only

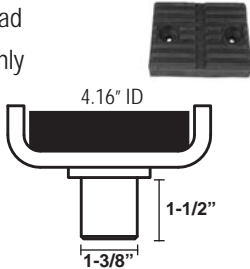

1-3/8" (35MM) PIN OD Type
NSP

Frame Cradle Adapter Base & Square Rubber Pad
 with 1-3/8" (35 mm) Diameter Pin for BendPak Lifts

BH-7480-07 (Ref 17107022) Adapter Base with Pad
 BH-7480-07-1 (Ref 17107021) Adapter Base Only
 BH-7256-20P (Ref 17108189) Replacement Pad Only



Page



Height Extensions and Adapters For BendPak Lifts

Please always confirm dimensions before ordering. Height Extensions and Adapters come in many different styles and dimensions. SVI is well-known as the adapter expert, specializing in top quality standard and custom adapters. SVI is your answer.





MANY MORE AVAILABLE!
See common adapters and pads at the beginning of this catalog:
Height Extensions & Adapters By Type / Style
Includes Nesting Style Height Extensions, Nesting Pad Adapters,
Slip-On Style, Drop-On Style, Adjustable and Fixed Adapters, and more!



Additional Height Extensions for BendPak Lifts FOR VARIOUS MODELS



**Type NS
Nesting Style
Height Extensions
for BendPak
2-3/8" (60mm) Diameter Pin**

**2" Nesting Height Extension
2-3/8" (60 mm) Diameter Pin
(Ref 5215757)**
BH-7474-84 (1) Adapter
BH-7474-84-4 (4) Adapters



Type NS

**2-3/4" Nesting Height Extension
2-3/8" (60 mm) Diameter Pin
(Ref 5215758, 5746192)**
BH-7474-85 (1) Adapter
BH-7474-85-4 (4) Adapters



Type NS

**5-1/2" Nesting Height Extension
2-3/8" (60 mm) Diameter Pin
(Ref 5215759, 5746193)**
BH-7474-86 (1) Adapter
BH-7474-86-4 (4) Adapters



Type NS

Round Lift Pad Adapter with 2-3/8" (60 mm) Pin (Ref 5215760)
BH-7474-83-4 (4) Adapters with 60mm Pin & Pad Kit
BH-7474-83 (1) Adapter with 60mm Pin & Pad
BH-7474-78 Replacement Pad Only



Type NSP

Telescopic / Spin-Up Round Lift Pad Adapter 60 mm
Gives an extra 3" height clearance on 9,000 and 10,000 Lb Lifts
(not for use on lifts with low profile arms)

Individual Adapter
BH-7474-79TP (Ref 5215704)

Set of 4 Adapters
BH-7474-79TP-4 (Ref 5215762)



Type NSP

Replacement Slip-Over Pad: BH-7474-78

1-3/8" (35 MM) PIN DIAMETER • 1-13/16" LONG PIN
Specialty Wide Adapter for 2019, 2020 and newer Chevrolet 1500 Silverado and GM Sierra Trucks - 1-3/8" (35 mm) Pin Dia.
Features 7" Wide Lifting Area

BH-7479-348GMT-1 (1) Adapter with 35mm Pin & Pad
BH-7479-348GMT-2 (2) Adapters with 35mm Pin & Pad
Features BH-7542-75P Rectangle Rubber Pad



1-3/8" (35 mm) Pin Dia.

2-3/8" (60 MM) PIN DIAMETER • 1-13/16" LONG PIN
Specialty Wide Adapter for 2019, 2020 and newer Chevrolet 1500 Silverado and GM Sierra Trucks - 2-3/8" (60 mm) Pin Dia.
Features 7" Wide Lifting Area

BH-7479-349GMT-1 (1) Adapter with 60mm Pin & Pad
BH-7479-349GMT-2 (2) Adapters with 60mm Pin & Pad
Features BH-7542-75P Rectangle Rubber Pad



2-3/8" (60 mm) Pin Dia.

More Styles Available—See common "Height Extensions & Adapters By Type / Style" at the beginning of this catalog!



Height Extensions and Adapters For Benwil and Bishamon Lifts

Please always confirm dimensions before ordering. Height Extensions and Adapters come in many different styles and dimensions. SVI is well-known as the adapter expert, specializing in top quality standard and custom adapters. SVI is your answer.



MANY MORE AVAILABLE!

See common adapters and pads at the beginning of this catalog:
 Height Extensions & Adapters By Type / Style
 Includes Nesting Style Height Extensions, Nesting Pad Adapters,
 Slip-On Style, Drop-On Style, Adjustable and Fixed Adapters, and more!



Additional Height Extensions for Benwil Lifts and Bishamon Lifts FOR VARIOUS MODELS

FOR BENWIL, BISHAMON, AND MANY ADAPTERS

Rubber Arm Pads (Ref 100533)
 BH-7205 Individual Arm Pad
 BH-7205-4 Kit of 4 Pads and Fasteners
SVI includes both US and Metric Fasteners.





4-3/8" x 3-1/2"

Note: This pad is molded around a steel insert for stay put attachment to the lift arm.



Cross-section showing steel insert.

FOR BENWIL

Rubber Arm Pad (Square)
 (Ref 50509901)
 BH-7214-02 Individual Pad (1)



3-9/16" Square
2" Hole Centers

Slip-On Height Extension with Rectangle Pad

Fits over BH-7205 Rectangle Pad on Spin-Up

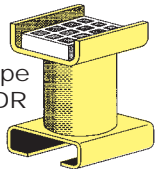

Type
HDR

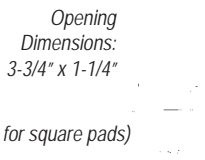

Opening
Dimensions:
3-3/4" x 1-1/4"

(Not for square pads)

BH-7202-55 • 3" Extension
BH-7202-56 • 4" Extension
BH-7200-12 • 6" Extension (Ref 100987)
BH-7202-58 • 7" Extension
BH-7202-59 • 8" Extension
BH-7200-12L • 9" Extension

Replacement Pad: BH-7205

Screw Adapter Extension (1)
 with for BW-9, BWO-9
BH-7206-36 (Ref 100962)

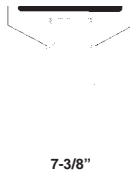

*Used in
BH-7207-97*

7-3/8"

**Fits:
BW-9,
BWO-9**

**Screw Assembly,
Truck Adapter for Benwil**
BH-7206-34 (Ref 100955)



*Confirm Threads and
Collar before ordering.*



Height Extensions and Adapters For Benwil and Bishamon Lifts

Please always confirm dimensions before ordering. Height Extensions and Adapters come in many different styles and dimensions. SVI is well-known as the adapter expert, specializing in top quality standard and custom adapters. SVI is your answer.



MANY MORE AVAILABLE!
 See common adapters and pads at the beginning of this catalog:
 Height Extensions & Adapters By Type / Style
 Includes Nesting Style Height Extensions, Nesting Pad Adapters,
 Slip-On Style, Drop-On Style, Adjustable and Fixed Adapters, and more!



Additional Height Extensions for Benwil Lifts and Bishamon Lifts FOR VARIOUS MODELS

1-3/8"-4 ACME THREADS • FOR ORIGINAL ARMS ONLY
 Steel Support Original Version for TP-7, TPO-7, TP-55, TPO-55
 Fits Original Arm Only • Threads 1-3/8"-4 Acme

BH-7205-02OV (Ref 205176)

Fits OEM Original Arm Only.
 For Benwil
 TP-7, TPO-7, TP-55, TPO-55
 Replacement Pad: BH-7205
 or Pad Kit: BH-7205-4



Other Versions Available. Confirm thread measurements before ordering.

1-3/8"-4 ACME THREADS • FOR SVI ARMS ONLY
 Steel Support SVI Version for TP-7, TPO-7, TP-55, TPO-55
 Fits SVI Replacement Arm Only • Threads 1-3/8"-4

BH-7205-02A (Ref 205176x)

Fits Replacement SVI-Made Arms Only
(Fits BH-7204-007)
 For Benwil TP-7, TPO-7, TP-55, TPO-55
 Replacement Pad: BH-7205
 or Pad Kit: BH-7205-4



Other Versions Available. Confirm thread measurements before ordering.

FEATURES 2" COLLAR / PIN Fits: BW-7, T-PRO-7, GPOA-7, GPOA-8

Pick Up Adapter Pad Assembly with 2" Collar
BH-7209-99 (Ref 100946)



1-1/2"-6 Thread
 2" Collar

Fits: BW-7, T-PRO-7, GPOA-7
 Replacement Pad: BH-7205

Truck Pick Up Adapter Pad with 2" Collar
BH-7210-03A (Ref 100945)
 1 Adapter Only

BH-7210-03 (Ref 101005)
 Kit of 4 Adapters and Hanger Bracket #
BH-7210-03B (Ref 300972)



Specialty Wide Adapter for 2019, 2020 and newer Chevrolet 1500 Silverado and GM Sierra Trucks 2" Collar Diameter
 Features 7" Wide Lifting Area (Ref 100946x)

BH-7209-99GMT-1 (1) Adapter with 2" Collar & Pad
BH-7209-99GMT-2 (2) Adapters with 2" Collar & Pad

Features BH-7542-75P Rectangle Rubber Pad



7" Wide Lifting Area



1-1/2"-6 Threads
 2" Collar Diameter

2" NUT/COLLAR OD
 Steel Support & Adjustable Nut Adapter Pad Assembly with 2" Nut / Collar with Lip / 1-1/2"-4 Acme Screw
BH-7205-02RD For Benwil

Kit Assembly Includes:
 BH-7205-02B (ref 00102500) Steel Support
 BH-7205-04A 2" OD Adjust Nut with 1-1/2"-4 Threads
 BH-7205 Rubber Arm Pad
 Pad Fasteners & Roll Pin



Replacement Pad: BH-7205
 or Pad Kit: BH-7205-4

Looking for a custom adapter with anti-slip sides on the pad, contact SVI!



Height Extensions and Adapters For Benwil and Bishamon Lifts

Please always confirm dimensions before ordering. Height Extensions and Adapters come in many different styles and dimensions. SVI is well-known as the adapter expert, specializing in top quality standard and custom adapters. SVI is your answer.



MANY MORE AVAILABLE!

See common adapters and pads at the beginning of this catalog:
 Height Extensions & Adapters By Type / Style
 Includes Nesting Style Height Extensions, Nesting Pad Adapters,
 Slip-On Style, Drop-On Style, Adjustable and Fixed Adapters, and more!



Additional Height Extensions for Benwil Lifts and Bishamon Lifts FOR VARIOUS MODELS

FEATURES 2-1/4" COLLAR

Fits: GPO-9, GPOA-9, BW-9, BWO-9, GPOA-10

Pick Up Adapter Pad Assembly with 2-1/4" Collar
BH-7208-66B
 (Ref 100965, 100967)



1-3/4"-6
ACME
Threads
2-1/4" Collar

Replacement Pad: BH-7205

Specialty Wide Adapter for 2019, 2020 and newer Chevrolet 1500 Silverado and GM Sierra Trucks 2-1/4" Collar Diameter
Features 7" Wide Lifting Area (Ref 100965x)

BH-7208-66GMT-1 (1) Adapter with 2-1/4" Collar & Pad
BH-7208-66GMT-2 (2) Adapters with 2-1/4" Collar & Pad

Features BH-7542-75P Rectangle Rubber Pad

TYPE
GMT

7" Wide
Lifting Area



2-1/4" Collar Diameter

Truck Pick Up Adapter Pad (1) with 2-1/4" Collar
BH-7207-01 (Ref 101086)



Fits:
 BW-9,
 BWO-9,
 GPO-9
 GPOA-9
 GPOA-10

Max Height is about 9"

(Other Ref 101085, 100958, 100961)

Truck Pick Up Adapter Pad with 2-1/4" Collar
BH-7207-97A (Ref 100963)
 1 Adapter Only

BH-7207-97 (Ref 101006)
 Kit of 4 Adapters



8.625" Min. Height
 14.25" Max. Height

Fits: GP-9, GPO-9

2-1/2" PIN OD
FIXED Adapter Base and Pad
 2-1/2" Pin OD x 2" Long
BH-7209-89

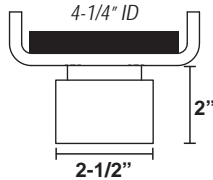

Replacement Pad: BH-7205



Height Extensions and Adapters For Benwil and Bishamon Lifts

Please always confirm dimensions before ordering. Height Extensions and Adapters come in many different styles and dimensions. SVI is well-known as the adapter expert, specializing in top quality standard and custom adapters. SVI is your answer.







MANY MORE AVAILABLE!
See common adapters and pads at the beginning of this catalog:
Height Extensions & Adapters By Type / Style
Includes Nesting Style Height Extensions, Nesting Pad Adapters,
Slip-On Style, Drop-On Style, Adjustable and Fixed Adapters, and more!



Additional Height Extensions for Benwil Lifts and Bishamon Lifts FOR VARIOUS MODELS

FEATURES 2-7/16" COLLAR

<p>Steel Support & Adjustable Nut Adapter Pad Assembly with 2-7/16" Nut / Collar with Lip on Top / 1-1/2"-4 Acme Screw BH-7205-02 (Ref 00102500, LAE000000)</p> <p>Kit Assembly Includes: BH-7205-02B (ref 00102500) Steel Support BH-7205-04 (ref 11319950) Adjust Nut BH-7205 Rubber Arm Pad Pad Fasteners Roll Pin</p> <div style="text-align: center;">  <p><i>Replacement Pad: BH-7205 or Pad Kit: BH-7205-4</i> Fits: old GP7, GPO7</p> <p><i>Looking for an adapter with anti-slip sides on the pad, contact SVI!</i></p> </div>	<p>Adjustable Truck Pick Up Adapter 7-1/2" to 11.5" 2-7/16" Collar</p> <p>BH-7201-81 (Ref TA-7) Truck Height Extension Adapter No Pad Style</p> <div style="text-align: center;">  <p>Fits: old GP7, GPO7 <i>BH-7201-81 Pictured</i></p> </div> <p>BH-7201-81P (Ref TA-7P) Truck Height Extension Adapter with BH-7205 Pad Rectangle Top</p>
<p>Steel Support & Adjustable Nut Adapter Pad Assembly with 2 Anti-Slip Sides • 2-7/16" Nut / Collar with Lip on Top 1-1/2"-5 Acme Screw</p> <p>BH-7205-02AL</p> <div style="text-align: center;"> <p><i>Replacement Pad: BH-7205 or Pad Kit: BH-7205-4</i> Fits: old GP7, GPO7</p> </div>	<p>Specialty Wide Adapter for 2019, 2020 and newer Chevrolet 1500 Silverado and GM Sierra Trucks 2-7/16" Nut / Collar Dia. <i>Features 7" Wide Lifting Area (Ref 100946x)</i></p> <p>BH-7205-02GMT (1) Adapter with 2-7/16" Collar & Pad BH-7205-02GMT-2 (2) Adapters with 2-7/16" Collar & Pad <i>Features BH-7542-75P Rectangle Rubber Pad</i></p> <div style="display: flex; align-items: center;"> <div style="border: 1px solid black; padding: 2px; margin-right: 10px;"> <p>TYPE GMT <small>7" Wide Lifting Area</small></p> </div> <div style="margin-right: 10px;"> <p>Fits: old GP7, GPO7</p> </div> <div style="margin-right: 10px;"> <p>1-1/2"-4 Screw with 2-7/16" Nut / Collar</p> </div> <div style="text-align: center;">  </div> </div>

FEATURES 3" COLLAR

Steel Support & Adjustable Nut and Square Adapter Pad with 3" Nut / Collar with Lip on Top / 2"-4 Acme Screw
BH-7209-03AM (Ref 00067760, 67760)



With Square Pad
Replacement Pad: BH-7214-02

Fits: TP-9

Looking for a custom adapter with anti-slip sides on the pad, contact SVI!

More Styles Available—See common "Height Extensions & Adapters By Type / Style" at the beginning of this catalog! 87



Height Extensions and Adapters For Challenger Lifts

Please always confirm dimensions before ordering. Height Extensions and Adapters come in many different styles and dimensions. SVI is well-known as the adapter expert, specializing in top quality standard and custom adapters. SVI is your answer.

MANY MORE AVAILABLE!
 See common adapters and pads at the beginning of this catalog:
 Height Extensions & Adapters By Type / Style
 Includes Nesting Style Height Extensions, Nesting Pad Adapters,
 Slip-On Style, Drop-On Style, Adjustable and Fixed Adapters, and more!

FOR CHALLENGER / VBM AND MANY ADAPTERS
Standard Octagon Rubber Arm Pad

BH-7225-01
 Octagon Rubber Arm Pad (1)

BH-7225-01-4
 Rubber Arm Pad Kit for 1 Lift
 (Includes 4 pads and hardware)

Also see Heavy Duty Version.

FOR CHALLENGER / VBM AND MANY ADAPTERS
Heavy Duty Octagon Rubber Arm Pad

BH-7225-01X
 HD Rubber Arm Pad (1)

BH-7225-01K
 HD Pad Kit for 1 Lift
 (Includes 4 pads and hardware)

BH-7225-01KL
 HD Pad Kit for 1 Lift
 with Long Bolts
 (Includes 4 pads and hardware)

FOR CHALLENGER AND QUALITY LIFTS

Square Rubber Pad for CL10, VS10, others

BH-7232-01 (Ref A1104, B1104) 1 Pad
BH-7232-01-4 (Ref A11052) Kit of 4 Pads with Fasteners

FOR CHALLENGER AND QUALITY LIFTS

Heavy Duty Square Rubber Pad for CL10, VS10, others

BH-7232-01HD (Ref A1104x, B1104x) 1 Pad
BH-7232-01HD-4 (Ref A11052x) Kit of 4 Pads with Fasteners

FOR CHALLENGER, QUALITY, AND LAUNCH
Round Rubber Pads for CL10, VS10, others (Ref B2208)
Sold Individually

BH-7232-93 Standard (1 Pad)
BH-7232-93F Fabric Reinforced (1 Pad)

FOR CHALLENGER, AMMCO, LAUNCH, OTHERS
Specialty Urethane Snap-In Pad for OEM Version of Adapter for 2019, 2020 and newer Chevrolet 1500 Silverado and GM Sierra Trucks

BH-7232-98GMAP (Ref B2280-01) Replacement Pad (1 Pad)

Specialty Wide Style Snap-In Pad for OEM Version Adapter for 2019, 2020, and Newer GM/Chevy Trucks

Approximately 6" x 3-1/2"

FOR CHALLENGER & QUALITY LIFTS
Round Rubber Arm Pad with Center Bolt Hole (Ref 26K25030)

BH-7232-94 1 Pad Only
 Sold Individually

4-3/4" OD
 1" Thick

SVI offers Direct Fit™ Replacement Arms and Arm Restraint Kits for many Challenger Lift Models

Call SVI today with your lift model for details on how to get what you need made!



Height Extensions and Adapters For Challenger Lifts

Please always confirm dimensions before ordering. Height Extensions and Adapters come in many different styles and dimensions. SVI is well-known as the adapter expert, specializing in top quality standard and custom adapters. SVI is your answer.



MANY MORE AVAILABLE!
See common adapters and pads at the beginning of this catalog:
Height Extensions & Adapters By Type / Style
Includes Nesting Style Height Extensions, Nesting Pad Adapters,
Slip-On Style, Drop-On Style, Adjustable and Fixed Adapters, and more!



FOR CHALLENGER, AMMCO, LAUNCH, OTHERS

Octagon Heavy Duty Rubber Pad vs. Urethane Pad

An SVI Exclusive

for Challenger CL-10 and many others

SVI is offering this Heavy-Duty Rubber Pad as an alternative to the Urethane Snap-In Pad (Ref A1104-H) that you have been ordering. The issue we've found with the Urethane Pad is called "compression set". With the weight of the vehicle pressing down on the urethane pad, it is pancaking or compressing the pad outward. The urethane does not rebound well and takes a compression set. As the urethane pad gets wider and wider against the two solid sides it is rejected from expanding horizontal and subsequently bows upward causing the undesirable outcome and appearance. This new Heavy-Duty Rubber Arm Pad is the better choice for your application.



An example of a "compression set" urethane pad on Challenger Lift



An Alternative to Snap-In Urethane Pad

Heavy Duty Bolt-On Style Rubber Arm Pad

Each pad is produced from a special 3/8" thick 2-ply durable reinforced material to increase service life.



Urethane Snap-In Style Pads In Adapter Above

FOR CHALLENGER, AMMCO, LAUNCH, OTHERS

Snap-In Urethane Pad (Ref A1104-H, A1104H)

BH-7232-01U 1 Pad — Sold Individually



4-11/32" x 4"
2 Snap-In Pegs
On Bottom

The Better Choice!

Does Not Curl Up Like Urethane!

Heavy Duty Bolt-On Rubber Arm Pad An SVI Exclusive
BH-7232-01OHD 1 Pad
BH-7232-01OHD-4 Set of 4 Pads

An Alternative to Snap-In Urethane Pad (Ref A1104-H, A1104H)

Make the Better Choice, Order BH-7232-01OHD-4

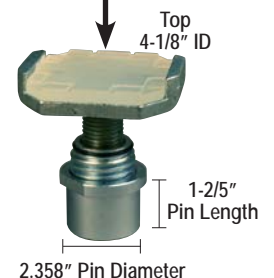

THIS ADAPTER WITH URETHANE SNAP-IN PAD IS COMMON ON CHALLENGER, AMMCO, LAUNCH, MAGNUM, QUALITY LIFTS, AND OTHERS

BH-7232-01UPB (Ref B2270)

Drop-In Adapter / Foot Pad Assembly with Urethane Pad

Works well with BH-7234-119 (ref 10315) Height Extension Kit

Replacement Pad: BH-7232-01U (Ref A1104H, Urethane) or BH-7232-01OHD (Rubber)

Replace your snap-in urethane pads with SVI's Bolt-On Rubber Pad Alternative—The Better Choice!



Height Extensions and Adapters For Challenger Lifts

Please always confirm dimensions before ordering. Height Extensions and Adapters come in many different styles and dimensions. SVI is well-known as the adapter expert, specializing in top quality standard and custom adapters. SVI is your answer.



MANY MORE AVAILABLE!
See common adapters and pads at the beginning of this catalog:
Height Extensions & Adapters By Type / Style
Includes Nesting Style Height Extensions, Nesting Pad Adapters,
Slip-On Style, Drop-On Style, Adjustable and Fixed Adapters, and more!



Additional Height Extensions for Challenger Lifts FOR VARIOUS MODELS

2-1/8" NUT / COLLAR OD

Complete Pad Assembly
2-1/8" OD Collar
Not Frame Engaging
BH-7232-67 (Ref 12563)



1-3/8"-6 Threads 2-1/8" OD Collar
Replacement Pad—See BH-7101-00

2-1/8" NUT / COLLAR OD • 1-3/4" LONG PIN
Specialty Wide Adapter for 2019, 2020 and newer Chevrolet 1500 Silverado and GM Sierra Trucks - 2" Pin Diameter
Features 7" Wide Lifting Area

BH-7231-47 (Ref B2280x) (1) Adapter Base and Pad
BH-7231-47K (Ref B2280PRx) (2) Adapter Bases and Pads

Features BH-7542-75P Rectangle Rubber Pad

TYPE
GMT

7" Wide Lifting Area



Important: Confirm Dimensions 2-1/8" Nut Diameter

2.135" PIN OD X 1-3/4" LONG PIN

2.135" (55 MM) PIN OD • 1-3/4" PIN LENGTH

Nesting Style Height Extensions for Old 12000 Model

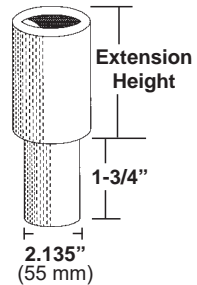
BH-7234-279 (Ref 12562) • 3" Extension
BH-7234-278 (Ref 12561) • 6" Extension

Type NS



Height Extensions and Adapters For Challenger Lifts

Please always confirm dimensions before ordering. Height Extensions and Adapters come in many different styles and dimensions. SVI is well-known as the adapter expert, specializing in top quality standard and custom adapters. SVI is your answer.



MANY MORE AVAILABLE!
See common adapters and pads at the beginning of this catalog:
Height Extensions & Adapters By Type / Style
Includes Nesting Style Height Extensions, Nesting Pad Adapters,
Slip-On Style, Drop-On Style, Adjustable and Fixed Adapters, and more!



Additional Height Extensions for Challenger Lifts

FOR CHALLENGER CL9, CL10, E10, VS10, X10, SA10, OTHERS

Also for Ammco®* Newer Models, Launch TLT210 and TLT211 Series, Magnum OE10, Quality Lifts Q10

2-3/8" (60mm) NUT / COLLAR / PIN OD



Pin Diameter
2-3/8"

Pin Length
1-1/2"

Height Extension Kit for Challenger CL9/CL10

Pin Diameter 2-3/8" • Pin Length 1-1/2"

BH-7234-119 (Ref 10315) KIT COMES WITH:
3" Tall Height Extension - Qty (4)
6" Tall Height Extension - Qty (2)
Qty (2) Hanging Brackets With Hardware

SVI Part #	OEM #	Pin OD	Pin Length	Description
BH-7234-119	10315	2-3/8"	1-1/2"	Height Extension Kit
BH-7234-119A	B2206-3	2-3/8"	1-1/2"	3" Height Extension
BH-7234-119B	B2206-6, CLF10313	2-3/8"	1-1/2"	6" Height Extension
BH-7234-119C	B2209			Hanging Bracket
				Pan Head Screws

Included with Kit

2-3/8" NUT/COLLAR OD
BH-7232-98 (Ref B2260 / B2250)
Drop-In Adapter /
Foot Pad Assembly
with Round Rubber Pad

*Works well with
BH-7234-119 (ref 10315)
Height Extension Kit*

Replacement Pad: BH-7232-93



2-3/8" NUT/COLLAR OD
BH-7232-01UPB (Ref B2270)
Drop-In Adapter /
Foot Pad Assembly
with Urethane Pad

*Works well with
BH-7234-119 (ref 10315)
Height Extension Kit*

Replacement Pad: BH-7232-01U (Ref A1104H, Urethane) or BH-7232-01OHD (Rubber)



2-3/8" (60 MM) NUT / COLLAR OD • 1-3/5" LONG PIN
Specialty Wide Adapter for 2019, 2020 and newer Chevrolet
1500 Silverado and GM Sierra Trucks - 2" Pin Diameter
Features 7" Wide Lifting Area

BH-7232-98GMT-1 (Ref B2280x) (1) Adapter Base and Pad
BH-7232-98GMT (Ref B2280PRx) (2) Adapter Bases and Pads

Features BH-7542-75P Rectangle Rubber Pad

**TYPE
GMT**

7" Wide
Lifting Area

Important: Confirm
Dimensions



Standard Snap-In Urethane Pad (Ref A1104-H, A1104H)
4-11/32" x 4" • 2 Snap-In Pegs On Bottom

BH-7232-01U 1 Pad — Sold individually

The Better Choice—Does Not Curl Up like Urethane:
Heavy Duty Bolt-On Rubber Arm Pad ▶
An SVI Exclusive

BH-7232-01OHD 1 Pad
BH-7232-01OHD-4 Set of 4 Pads



3/8" Thick
2-Ply

Page

More Styles Available—See common "Height Extensions & Adapters By Type / Style" at the beginning of this catalog!



Height Extensions and Adapters For Challenger Lifts

Please always confirm dimensions before ordering. Height Extensions and Adapters come in many different styles and dimensions. SVI is well-known as the adapter expert, specializing in top quality standard and custom adapters. SVI is your answer.



MANY MORE AVAILABLE!
 See common adapters and pads at the beginning of this catalog:
 Height Extensions & Adapters By Type / Style
 Includes Nesting Style Height Extensions, Nesting Pad Adapters,
 Slip-On Style, Drop-On Style, Adjustable and Fixed Adapters, and more!



Additional Height Extensions for Challenger Lifts FOR VARIOUS MODELS

2-3/8" (60mm) NUT / COLLAR / PIN OD

7" Nesting Height Extension
2-3/8" (60 mm) Diameter Pin
 BH-7234-119D (Ref B2206-7)

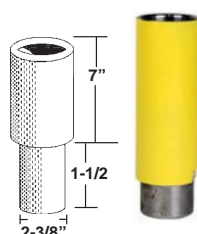

Type NS

2.359" (60 MM)" NUT OD
Complete Pad Assembly
 Not Frame Engaging
 BH-7234-120 (Ref B12062-12)



For Quality
 2"-4 Threads 2.359" OD Collar

Replacement Pad—See BH-7101-00

2.359" (60 MM)" NUT OD
Complete Pad Assembly
 Frame Engaging
 BH-7234-128 (Ref B12162S-12)



For Quality
 2-4-1/2 UNC-2A Threads 2.359" OD Collar

Replacement Pad—See BH-7232-01U



Frame Engaging Adapters for Challenger
 2.359" OD Pin

BH-7234-121A (Ref B2201) 1 Adapter
 BH-7234-125 (Ref 10314) Set of 2
 BH-7234-121 (Ref 10318) Set of 4

BH-7234-121K (Ref 10319) KIT - Set of 4 Adapters, Hangers, and Height Extensions

2.359" Pin Diameter

NOTE: Confirm Pin OD before ordering.



Frame Engaging Adapter Kit for Challenger Lifts
 (Ref 10319, 10318, B2201, 10314)
 2.359" OD Pin

BH-7234-121K (Ref 10319)
 Kit Includes Set of 4 Adapters, (2) Tall and (4) Short Height Extensions, (2) Extension Holders

2.359" Pin Diameter

NOTE: Confirm Pin OD before ordering.



Height Extensions and Adapters For Challenger Lifts

Please always confirm dimensions before ordering. Height Extensions and Adapters come in many different styles and dimensions. SVI is well-known as the adapter expert, specializing in top quality standard and custom adapters. SVI is your answer.





MANY MORE AVAILABLE!
See common adapters and pads at the beginning of this catalog:
Height Extensions & Adapters By Type / Style
Includes Nesting Style Height Extensions, Nesting Pad Adapters,
Slip-On Style, Drop-On Style, Adjustable and Fixed Adapters, and more!



Additional Height Extensions for Challenger Lifts

FOR VARIOUS MODELS

3-1/8" NUT / COLLAR / PIN OD

<p>Complete Screw-Up Pad Adapter Assembly <i>Not Frame Engaging</i></p> <p>BH-7234-208 (Ref B12062, 12062-12)</p> <div style="text-align: center;">  </div> <p>1-3/4"-5 UNC Threads 3-1/8" OD Collar</p> <p><i>Replacement Pad—See BH-7101-00</i></p>	<p>Complete Screw-Up Pad Adapter Assembly <i>Frame Engaging</i></p> <p>BH-7234-128-15 (Ref B12162S)</p> <div style="text-align: center;">  </div> <p>2"-4-1/2 UNC Threads 3-1/8" OD Collar</p> <p><i>Replacement Pad—See BH-7232-01U</i></p>	<p>Nesting Height Extensions 3-1/8" Diameter Pin</p> <table style="width: 100%; border: none;"> <tr> <td style="width: 30%;">BH-7234-210</td> <td style="width: 30%;">(Ref B12069, 12069)</td> <td style="width: 40%;">4" Extension</td> </tr> <tr> <td>BH-7234-208-5</td> <td>(Ref 12062-12x)</td> <td>5" Extension</td> </tr> <tr> <td>BH-7234-208-6</td> <td>(Ref 12062-12x)</td> <td>6" Extension</td> </tr> <tr> <td>BH-7234-211</td> <td>(Ref 12068)</td> <td>8" Extension</td> </tr> </table> <p>ALSO AVAILABLE BH-7234-211H (Ref 12071) Extension Holder Rack</p> <div style="text-align: center;">  </div> <p>3-1/8" Pin Diameter Type NS</p>	BH-7234-210	(Ref B12069, 12069)	4" Extension	BH-7234-208-5	(Ref 12062-12x)	5" Extension	BH-7234-208-6	(Ref 12062-12x)	6" Extension	BH-7234-211	(Ref 12068)	8" Extension
BH-7234-210	(Ref B12069, 12069)	4" Extension												
BH-7234-208-5	(Ref 12062-12x)	5" Extension												
BH-7234-208-6	(Ref 12062-12x)	6" Extension												
BH-7234-211	(Ref 12068)	8" Extension												

Specialty Wide Adapter for 2019, 2020 and newer Chevrolet 1500 Silverado and GM Sierra Trucks - Screw Up Adapter
Features 7" Wide Lifting Area • SVI Exclusive

BH-7234-208GMT	12062-12x	(1) Adapter with Pad
BH-7542-75P	Replacement Pad Only	
BH-7542-75P-4	Replacement Pads (Set of 4)	

TYPE
GMT
7" Wide Lifting Area

2"-4-1/2
UNC
Threads 3-1/8" OD
Collar

1-1/4"-7 THREADS

1-1/4"-7 THREADS • 6" SQUARE TOP WITH CORNERS TURNED UP

Screw-Up Height Extension with Octagon Rubber Pad
Features Replaceable Rubber Pad BH-7225-01
Slip-Over Extensions Available!

BH-7090-20	• 4" Adapter • 6" Top	
BH-7090-21	• 5" Adapter • 6" Top	
BH-7090-22	• 6" Adapter • 6" Top	
BH-7090-23	• 7" Adapter • 6" Top	
BH-7090-24	• 8" Adapter • 6" Top	
BH-7227-41	• 10" Adapter • 6" Top (Ref 10061, 200084)	
BH-7227-42	• 12" Adapter • 6" Top (Ref 200085)	



6" Top
Type SUH6
Threads
1-1/4"-7

Replacement Rubber Pad: BH-7235-90A / BH-7235-90 (Kit)
or Heavy Duty Version BH-7235-90AX / BH-7235-90K (Kit)



Height Extensions and Adapters For Challenger Lifts

Please always confirm dimensions before ordering. Height Extensions and Adapters come in many different styles and dimensions. SVI is well-known as the adapter expert, specializing in top quality standard and custom adapters. SVI is your answer.



MANY MORE AVAILABLE!

See common adapters and pads at the beginning of this catalog:
 Height Extensions & Adapters By Type / Style
 Includes Nesting Style Height Extensions, Nesting Pad Adapters,
 Slip-On Style, Drop-On Style, Adjustable and Fixed Adapters, and more!



Additional Height Extensions for Challenger Lifts FOR VARIOUS MODELS

Heavy Duty Screw Up Adapter Base & Pad
 Features Replaceable Rubber Pad BH-7232-01

SVI Exclusive: Heavy duty adapter base with increased plate thickness and additional welding process.

Alternative for OE Style A1100, A1101, (B1100 is metric)



1-3/8"-6
Threads

BH-7232-17HDA-P	Heavy Duty Base with Pad
BH-7232-17HDA	Heavy Duty Base Only
BH-7232-17L	Longer Truck Adapter CL9
BH-7232-17L-4	Longer Truck Adapter CL9 - Set of 4

Replacement Pad: BH-7232-01 or BH-7232-01HD

Slip-On Height Extension with Square Pad
Fits over BH-7232-17HDA-P Spin-Up Adapter with Square Pad



CL9
CL10
X10

Features Rubber Pad BH-7232-01

SVI Part #	Ref #	Height	Details
BH-7231-96		3"	Fixed
BH-7232-00	A1105-06	6"	Fixed
BH-7231-99	A1105-10	10"	Fixed

Choose Fixed or Adjustable

BH-7231-97		4"-6"	Adjustable
BH-7231-98		6"-9-1/2"	Adjustable

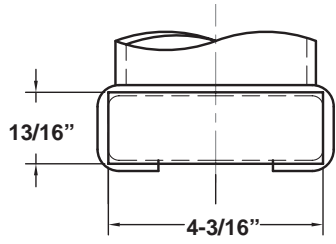

Adapter Base Inside Dimensions
Shape may vary depending on height extension.



Screw Adapter with Metric Threads

BH-7234-20HDP	(Ref X10-100x)	Heavy Duty Base with Pad
BH-7234-20HD	(Ref X10-066x)	Heavy Duty Base Only
BH-7234-20P		Standard Base with Pad
BH-7234-20	(Ref X10-066)	Standard Base Only

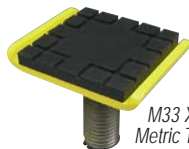

M33 X 3.50
Metric Threads

Replacement Pad: BH-7232-01 or BH-7232-01HD

1-3/8"-6 THREADS • SCREW-UP ADAPTER AND PAD
 Specialty Wide Adapter for 2019, 2020 and newer Chevrolet 1500 Silverado and GM Sierra Trucks 1-3/8"-6
 Features 7" Wide Lifting Area • SVI Exclusive

BH-7232-17GMT-1	(1) Screw Up Adapter with Pad
BH-7232-17GMT	(2) Screw Up Adapters with Pad

Features BH-7542-75P Rectangle Rubber Pad

TYPE
GMT

7" Wide
Lifting Area



1-3/8"-6 Screw

Hanger Bracket and Bracket Kit for Height Extensions
 For use on Challenger CL9, CL10, and other makes / models

Note: Height Extensions Sold Separately

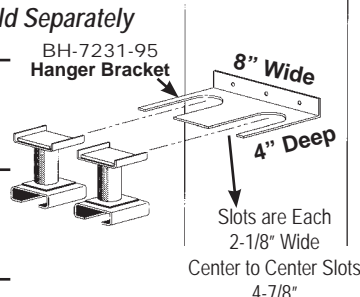
BH-7231-95K Height Extension Kit 2 Brackets—Holds 4 Adapters Includes Fasteners	
BH-7231-95 1 Bracket Only Holds 2 Adapters (Fasteners Not Included)	



Height Extensions and Adapters For Challenger Lifts

Please always confirm dimensions before ordering. Height Extensions and Adapters come in many different styles and dimensions. SVI is well-known as the adapter expert, specializing in top quality standard and custom adapters. SVI is your answer.



MANY MORE AVAILABLE!
 See common adapters and pads at the beginning of this catalog:
 Height Extensions & Adapters By Type / Style
 Includes Nesting Style Height Extensions, Nesting Pad Adapters,
 Slip-On Style, Drop-On Style, Adjustable and Fixed Adapters, and more!



Additional Height Extensions for Challenger Lifts FOR VARIOUS MODELS

**Spin-Up Adapter without Pad
(Rectangle Top) for 15 / 18**

BH-7234-209 (Ref 12063)

*4" x 5" Rectangle Top
with 2 Bolt Holes*



*1-3/4"-5
Threads*

6-1/8" X 1" OPENING DIMENSIONS

**Specialty Wide Adapter for 2019, 2020 and newer Chevrolet
1500 Silverado and GM Sierra Trucks • 3" Slip On**

Features 7" Wide Lifting Area • SVI Exclusive

BH-7227-23GMT (1) 3" Slip On Height Extension

Features BH-7542-75P Rectangle Rubber Pad

**TYPE
GMT**

7" Wide
Lifting Area

Fits over BH-7225-01 Rubber Pad

Opening Dimensions 6-1/8" x 1"



FOR OEM SPECIALTY ADAPTERS ONLY

**Specialty Urethane Snap-In Pad for OEM Version of
Adapter for 2019, 2020 and newer Chevrolet 1500 Silverado
and GM Sierra Trucks**

BH-7232-98GMAP (Ref B2280-01) Replacement Pad (1)



*Specialty Wide Style Snap-In Pad
for OEM Version Adapter for
New GM/Chevy Trucks*



Approximately 6" x 3-1/2"



Height Extensions and Adapters For Challenger Lifts

Please always confirm dimensions before ordering. Height Extensions and Adapters come in many different styles and dimensions. SVI is well-known as the adapter expert, specializing in top quality standard and custom adapters. SVI is your answer.



MANY MORE AVAILABLE!
 See common adapters and pads at the beginning of this catalog:
 Height Extensions & Adapters By Type / Style
 Includes Nesting Style Height Extensions, Nesting Pad Adapters,
 Slip-On Style, Drop-On Style, Adjustable and Fixed Adapters, and more!



Additional Height Extensions for Challenger Lifts FOR VARIOUS MODELS

**Slip-Over
Luxury Car Adapter**
Sold Individually
BH-7231-06 (Ref 10199)

Opening Dimensions:
5-3/16" x 3-5/32"

Use with Rubber Pad: BH-7101-00

FOR ROLLING BRIDGE JACKS
 Adjust-A-Spot
 10" Extension Kit for Challenger Rolling Jacks
 Includes 2 Extensions with Pins

BH-7231-46 (Ref RJ45-ADT)	3-3/8"
BH-7231-46N (Ref RJ45)	4" x 1-1/4"
BH-7231-46W (Ref RJQRJ04H)	

New and Improved!
Contact SVI today!

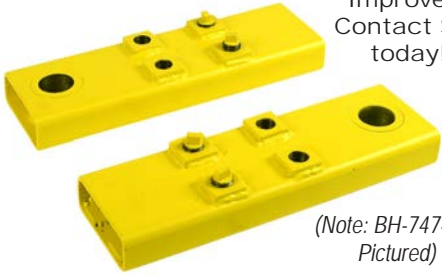

(Note: BH-7474-81 Pictured)

For LIFTS WITH FLIP-UP STYLE ADAPTERS - MANY MODELS

BH-9620-05
(Ref M2139, M-2139, VM2139)

High Adapter Pad



No Longer Available—
Call for Conversion.
See BH-9614-48

BH-9620-06
(Ref M2138, M-2138, VM2138)

Low Adapter Pad





Height Extensions and Adapters For Challenger Lifts

Please always confirm dimensions before ordering. Height Extensions and Adapters come in many different styles and dimensions. SVI is well-known as the adapter expert, specializing in top quality standard and custom adapters. SVI is your answer.



MANY MORE AVAILABLE!

See common adapters and pads at the beginning of this catalog:
 Height Extensions & Adapters By Type / Style
 Includes Nesting Style Height Extensions, Nesting Pad Adapters,
 Slip-On Style, Drop-On Style, Adjustable and Fixed Adapters, and more!



Additional Height Extensions for Challenger Lifts

For LIFTS WITH FLIP-UP STYLE ADAPTERS - MANY MODELS

SPCW1 Slip-Over Protective Pad
 Drop-On Protective Rectangle Rubber Pad Adapter for Flip-Up
Protects Vehicle Undercoating
 BH-9681-06 • 1" Height

Fits over Flip Up Adapters

Opening Dimensions:
 5-7/8" x 1"
 Type
 SPCW1

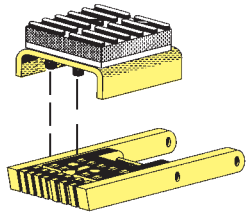

*Pictured on Flip-Ups,
 Sold Separately.*

Replaceable Pad: BH-7101-00

SPCW Slip-Over Protective Pad - FIXED
 Drop-On FIXED Height Extension with Pad for Flip-Ups

BH-9681-01 • 3" Adapter
 BH-9681-02 • 4" Adapter
 BH-9681-03 • 5" Adapter
 BH-9681-04 • 6" Adapter

Fits over Flip Up Adapters

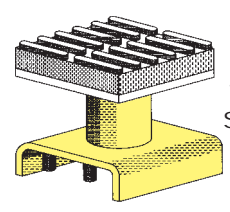

Type
 SPCW

Opening Dimensions:
 5-7/8" x 1"

Replaceable Pad: BH-7101-00

ASPCW Slip-Over Protective Pad-ADJ.
 4" to 6" Drop-On ADJUSTABLE Height Extension with
 Rectangle Rubber Arm Pad
 BH-9681-05

Fits over Flip Up Adapters

Opening Dimensions:
 5-7/8" x 1"



TYPE
 ASPCW

Pictured on Flip-Ups, Sold Separately.

Replaceable Pad: BH-7101-00

SONRW Narrow Drop-On Extension
For Close to Frame Obstructions
 BH-9680-00 • 9" Drop-On Height Extension with Rectangle Pad

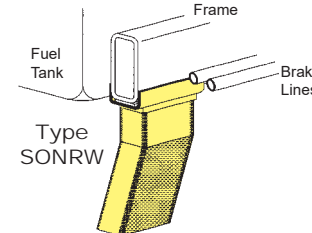

Opening Dimensions:
 5-5/8" x 1-3/16"

Fits over Flip Up Adapters

Avoids denting or puncturing fuel tank and smashing brake lines. Commonly sold for use on the rear of late model trucks and SUVs.

Replaceable Pad: BH-9900-10

SOCW Drop-On Extension Without Pad
SOCWP Drop-On Extension With Pad

Drop-On Height Extension for Flip-Ups

BH-9680-01 (Ref KL-305) 9" Tall • SOCW Style without Pad
 BH-9380-01A 11" Tall • SOCW Style without Pad
 BH-9680-01B (Ref KL-305x) 9" Tall • SOCWP Style with Pad
 BH-9380-01C 11" Tall • SOCWP Style with Pad

NOTE: Also available as wide style GMT Adapters for use with 2019, 2020, and newer Chevrolet 1500 Silverado and GMC Sierra Trucks.

Inside Dimensions: 5-3/4" Wide

Opening Dimensions: 5-5/8" x 1-3/16"

Fits over Flip Up Adapters



BH-9680-01 BH-9680-01B
 BH-9680-01A BH-9680-01C
 Type Type
 SOCW SOCWP

For SOCWP, Replacement Rubber Pad: BH-9900-10 (3" x 5" x 3/8")

Page

More Styles Available—See common "Height Extensions & Adapters By Type / Style" at the beginning of this catalog! 97



Height Extensions and Adapters For Danmar Lifts

Please always confirm dimensions before ordering. Height Extensions and Adapters come in many different styles and dimensions. SVI is well-known as the adapter expert, specializing in top quality standard and custom adapters. SVI is your answer.



MANY MORE AVAILABLE!

See common adapters and pads at the beginning of this catalog:
Height Extensions & Adapters By Type / Style
Includes Nesting Style Height Extensions, Nesting Pad Adapters, Slip-On Style, Drop-On Style, Adjustable and Fixed Adapters, and more!



Additional Height Extensions for Danmar Lifts FOR VARIOUS MODELS

4-3/4" Square Bolt On Pad for Danmar (Ref 17108189)
 BH-7256-20P (1) Individual Pad
 BH-7256-20-KIT Kit of 4 Pads and Fasteners

4-3/4" x 4-3/4" Square

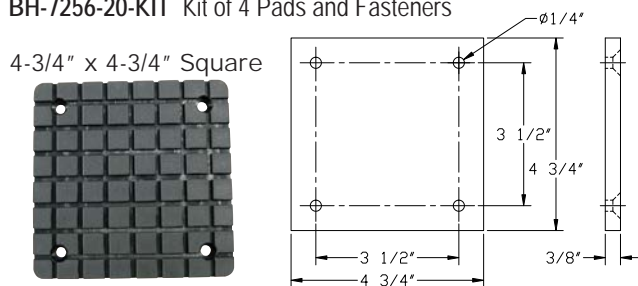

Frame Cradle Adapter Base & Rubber Pad with 1-3/8" (35 mm) Diameter Pin

BH-7480-07 (Ref 17107022) Adapter Base with Pad
 BH-7480-07-1 (Ref 17107021) Adapter Base Only
 BH-7256-20P (Ref 17108189) Replacement Pad Only



Type NSP

Round Slip Over Pad for Danmar (Ref 17108252, 5715017)
 BH-7474-78 (1) Individual Pad



Round Lift Pad Adapter with 1-3/8" (35 mm) Pin (Ref 17107036)

BH-7474-79C Adapter and Pad
 BH-7474-79 Adapter Only (without pad)
 BH-7474-80C Adapter and Pad - 1-11/16" Taller
 BH-7474-80 Adapter Only - 1-11/16" Taller
 BH-7474-78 Replacement Pad Only



Type NSP



Height Extensions and Adapters For Direct Lifts

Please always confirm dimensions before ordering. Height Extensions and Adapters come in many different styles and dimensions. SVI is well-known as the adapter expert, specializing in top quality standard and custom adapters. SVI is your answer.







MANY MORE AVAILABLE!

See common adapters and pads at the beginning of this catalog:
 Height Extensions & Adapters By Type / Style
 Includes Nesting Style Height Extensions, Nesting Pad Adapters,
 Slip-On Style, Drop-On Style, Adjustable and Fixed Adapters, and more!

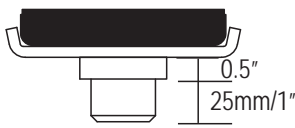

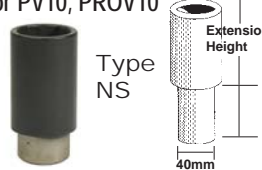
Additional Height Extensions for Direct Lifts FOR VARIOUS MODELS

<p>BH-7270-078 (Ref 680030C, 30400-6005-1) Adapter Base Assembly with Round Pad 1/2" Step</p>  <p style="text-align: center;">38mm (1-1/2") Pin Diameter</p> <p style="font-size: small;">Also See BH-7270-078 Replacement Pad: BH-7588-465</p>	<p>BH-7270-005 (Ref 30400-6005-2) Adapter Base Assembly with Round Pad - Tall Step</p>  <p style="text-align: center;">38mm (1-1/2") Pin Diameter</p> <p style="font-size: small;">Rubber Pad Not Included BH-7588-465</p>	<p style="color: orange;">FOR DIRECT LIFTS AND OTHERS</p> <p>1/2" Thick Round Rubber Arm Pad with Washer (Ref PV-6003)</p> <p style="text-align: center;">BH-7270-006 1 Pad</p>  <p style="font-size: small; text-align: center;">4-11/16" OD 3 Holes</p> <p style="font-size: x-small; text-align: right;">○○○ ○○○</p> <p style="font-size: small;">Note: This Pad is Used For Both 1-Hole and 2-Hole Applications</p>	
<p style="color: orange;">FOR DIRECT LIFTS</p> <p>Over Arm Adapter (Saddle) For use with Octagon Rubber Pad</p> <p>BH-7270-047 (Ref 30400-7013)</p> <p style="font-size: small;">Note: Pad Sold Separately Uses Replaceable Pad BH-7270-048</p> <p style="font-size: x-small;">Also see BH-7090-94 Series— Specify Arm Width</p>	<p style="color: orange;">FOR DIRECT & TUXEDO</p> <p>5" Octagon Rubber Pad (Ref 52200-3) BH-7270-048 Individual Pad</p>  <p style="font-size: small;">1/2" Thick Pad Holes are 3.6" Apart</p>	<p style="color: orange;">FOR DIRECT LIFTS</p> <p>Nesting Height Extension for PV10, PROV10</p>  <p style="font-size: small;">Type NS</p> <p>BH-7274-073 • 3" Extension (Ref 30500-6200)</p> <p>BH-7274-074 • 6-1/2" Extension (Ref 30500-6201)</p>	<p style="color: orange;">FOR DIRECT LIFTS</p> <p>Rectangle Rubber Arm Pad (1) for PRO-6MR BH-7250-01 (Ref PMR-6131)</p>  <p style="font-size: small;">1-1/8" Thick 4-9/16" x 3-1/8"</p>

Extensions for Rolling Bridge Jacks FOR PROJACK 3500

Please confirm dimensions when ordering.

Adjust-A-Spot
8-3/4" Extension Kit for Rolling Jacks
Includes 2 Extensions
BH-7274-175





Height Extensions and Adapters For Force Lifts

Please always confirm dimensions before ordering. Height Extensions and Adapters come in many different styles and dimensions. SVI is well-known as the adapter expert, specializing in top quality standard and custom adapters. SVI is your answer.



MANY MORE AVAILABLE!
 See common adapters and pads at the beginning of this catalog:
 Height Extensions & Adapters By Type / Style
 Includes Nesting Style Height Extensions, Nesting Pad Adapters,
 Slip-On Style, Drop-On Style, Adjustable and Fixed Adapters, and more!

Additional Height Extensions for Force Lifts FOR VARIOUS MODELS

FOR FORCE
 Slip-On Round Rubber Arm Pad
 (Ref 90292)
 BH-7240-02 (1) Pad Only
 Sold Individually

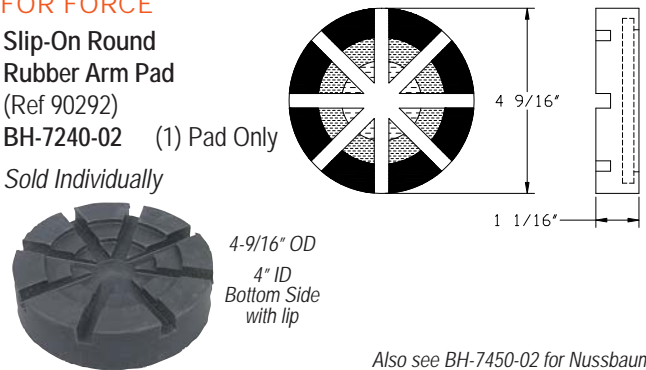

4-9/16" OD
 4" ID
 Bottom Side with lip

Also see BH-7450-02 for Nussbaum



Height Extensions and Adapters For Forward Lifts

Please always confirm dimensions before ordering. Height Extensions and Adapters come in many different styles and dimensions. SVI is well-known as the adapter expert, specializing in top quality standard and custom adapters. SVI is your answer.



MANY MORE AVAILABLE!
See common adapters and pads at the beginning of this catalog:
Height Extensions & Adapters By Type / Style
Includes Nesting Style Height Extensions, Nesting Pad Adapters,
Slip-On Style, Drop-On Style, Adjustable and Fixed Adapters, and more!



Additional Height Extensions for Forward Lifts FOR VARIOUS MODELS

1-3/8"-6 THREADS • SCREW-UP ADAPTER AND PAD
Spin-Up Height Extension with Octagon Rubber Pad
 Features Replaceable Rubber Pad BH-7235-90A 5-1/2" Top

BH-7091-32 • 4" Adapter
 BH-7091-33 • 5" Adapter
 BH-7091-34 • 6" Adapter
 BH-7091-35 • 7" Adapter
 BH-7091-36 • 8" Adapter

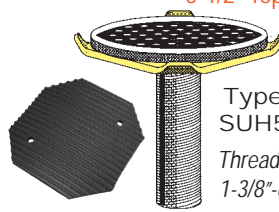

Type
SUH5
Threads
1-3/8"-6

Replacement Rubber Pad: BH-7235-90A / BH-7235-90 (Kit)
 or Heavy Duty Version BH-7235-90AX / BH-7235-90K (Kit)

1-3/8"-6 THREADS • SCREW-UP ADAPTER - NO PAD
Spin-Up Height Extension
Pad Not Included, Sold Separately

BH-7235-89 • 4" Adapter (Ref 070606)
 BH-7235-89A • 8" Adapter (Ref 070608)

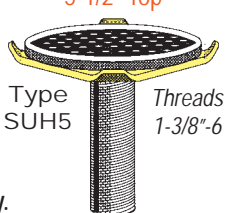

5-1/2" Top
Type
SUH5
Threads
1-3/8"-6

Pad Sold Separately.

1-3/4"-5 THREADS • SCREW-UP ADAPTER AND PAD
4" Spin Up Height Extension with Octagon Rubber Pad
 BH-7237-90 (Ref 137603-1) Individual (1) Adapter
 BH-7237-89 (Ref 137603) Set of 4 Adapters

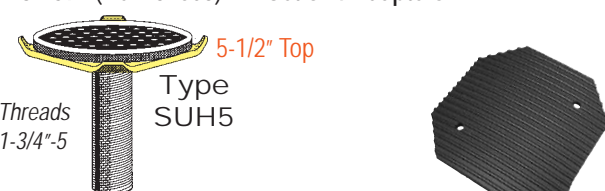

5-1/2" Top
Type
SUH5
Threads
1-3/4"-5

Replacement Rubber Pad: BH-7235-90A / BH-7235-90,
 or Heavy Duty Version BH-7235-90AX / BH-7235-90K

1-3/4"-5" THREADS • SCREW-UP ADAPTER AND PAD
Specialty Wide Adapter for 2019, 2020 and newer Chevrolet 1500 Silverado and GM Sierra Trucks
 Features 7" Wide Lifting Area • SVI Exclusive

BH-7237-95GMT 5" Adapter Base and Pad (Set of 2)
 BH-7237-95GMT-1 5" Adapter Base and Pad (1)
 BH-7237-99GMT 9" Adapter Base and Pad (Set of 2)
 BH-7237-99GMT-1 9" Adapter Base and Pad (1)

Features BH-7542-75P Rectangle Rubber Pad



1-3/4"-5
Threads

BH-7237-95GMT
BH-7237-95GMT-1



1-3/4"-5
Threads

BH-7237-99GMT
BH-7237-99GMT-1

**TYPE
GMT**
7" Wide
Lifting Area

FOR DPO15



Height Extensions and Adapters For Forward Lifts

Please always confirm dimensions before ordering. Height Extensions and Adapters come in many different styles and dimensions. SVI is well-known as the adapter expert, specializing in top quality standard and custom adapters. SVI is your answer.



MANY MORE AVAILABLE!

See common adapters and pads at the beginning of this catalog:
 Height Extensions & Adapters By Type / Style
 Includes Nesting Style Height Extensions, Nesting Pad Adapters,
 Slip-On Style, Drop-On Style, Adjustable and Fixed Adapters, and more!



Additional Height Extensions for Forward Lifts FOR VARIOUS MODELS

FOR FORWARD LIFTS, VBM (OLD SQUARE) & WORTH
Fixed Slip-On Height Extension with Octagon Pad
Fits over Spin-Up with Corners Turned Up with BH-7235-90A Pad. VBM Old Square is Flat.

BH-7236-60 • 3" Extension
 BH-7236-61 • 4" Extension
 BH-7236-62 • 5" Extension
 BH-7235-88 • 6" Extension
 BH-7236-63 • 7" Extension
 BH-7236-64 • 8" Extension
 BH-7236-65 • 9" Extension
 BH-7236-66 • 10" Extension

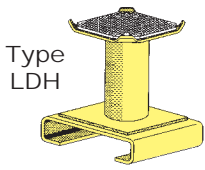

Type
LDH

Opening Dimensions:
5-3/4" x 15/16"

Replacement Pad: BH-7235-90A

FOR FORWARD LIFTS, VBM (OLD SQUARE) & WORTH
Adjustable Slip-On Height Extension with Octagon Pad
Fits over Spin-Up with Corners Turned Up and BH-7235-90A Pad. VBM Old Square is Flat.

BH-7236-77 • 4"-6" Adjustable
 BH-7236-78 • 6"-9-1/2" Adjustable

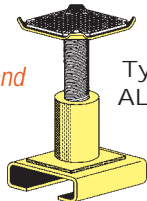

Type
ALDH

Opening Dimensions:
5-3/4" x 15/16"

Replacement Pad: BH-7235-90A

FOR FORWARD LIFTS, VBM (OLD SQUARE) & WORTH
Fixed Slip-On Height Extension with Rectangle Pad
Fits over Spin-Up with Four Corners Turned Up with BH-7235-90A Pad. VMB is flat.

BH-7236-67 • 3" Extension
 BH-7236-68 • 4" Extension
 BH-7236-69 • 5" Extension
 BH-7236-70 • 6" Extension
 BH-7236-71 • 7" Extension
 BH-7236-72 • 8" Extension
 BH-7236-73 • 9" Extension

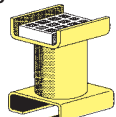

Type
HDR

Opening Dimensions:
5-3/4" x 15/16"

Replacement Pad: BH-7205

BH-7236-74 • 10" Extension
 BH-7236-75 • 11" Extension
 BH-7236-76 • 12" Extension

FOR FORWARD LIFTS, VBM (OLD SQUARE) & WORTH
Adjustable Slip-On Height Extension with Rectangle Pad
Fits over Spin-Up with BH-7235-90A Pad

BH-7236-79 • 4"-6" Adjustable
 BH-7236-80 • 6"-9-1/2" Adjustable

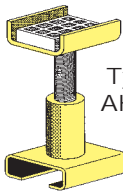

Type
AHDR

Opening Dimensions:
5-3/4" x 15/16"

Replacement Pad: BH-7205

FOR FORWARD LIFTS, VBM (OLD SQUARE) & WORTH
Slip-On Narrow Height Extension for Close to Frame Obstructions
Fits over Spin-Up with BH-7235-90A

BH-7236-81 • 3" Extension
 BH-7236-82 • 6" Extension
 BH-7236-83 • 9" Extension

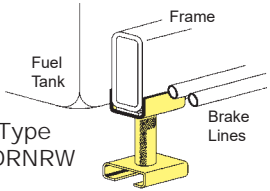

Type
HDRNRW

Opening Dimensions:
5-3/4" x 15/16"

Adjustable version also available.

Replacement Pad: BH-9755-50-1

FOR FORWARD LIFTS, VBM (OLD SQUARE) & WORTH
Adjustable Slip-On Narrow Height Extension for Close to Frame Obstructions
Fits over Spin-Up with BH-7235-90A Pad

BH-7236-84 • 4"-6" Adjustable
 BH-7236-85 • 6"-9-1/2" Adjustable

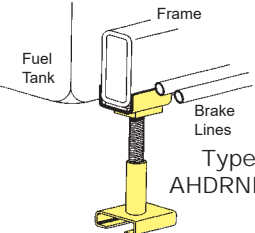

Type
AHDRNRW

Opening Dimensions:
5-3/4" x 15/16"

Replacement Pad: BH-9755-50-1



Height Extensions and Adapters For Forward Lifts

Please always confirm dimensions before ordering. Height Extensions and Adapters come in many different styles and dimensions. SVI is well-known as the adapter expert, specializing in top quality standard and custom adapters. SVI is your answer.



MANY MORE AVAILABLE!
See common adapters and pads at the beginning of this catalog:
Height Extensions & Adapters By Type / Style
Includes Nesting Style Height Extensions, Nesting Pad Adapters,
Slip-On Style, Drop-On Style, Adjustable and Fixed Adapters, and more!



Additional Height Extensions for Forward Lifts FOR VARIOUS MODELS

1-1/4" PIN OD
Nesting Height Extension Kit for Forward Lifts
1-1/4" Pin Diameter

BH-7239-120 (Ref 994257)
Kit Includes 4 Each of 1-1/2", 3" and 6" Adapters



Type NSP

1-1/4" PIN OD
BH-7235-94
Truck Adapter for Forward Lifts (No Pad)
1-1/4" Pin OD x 1-3/16" Long

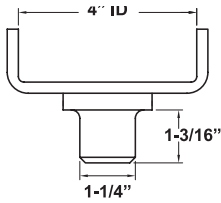

1-1/4" PIN OD
BH-7235-94RC
Round Adapter with Pad for Forward Lifts
1-1/4" Pin OD x 1-3/16" Long



Type NSP

Replaceable Pad: BH-7474-78

1-1/4" PIN OD
Nesting Adapter Pad for Forward Lifts (Ref 106605)
Features 5-1/2" Square Top with Corners Turned Up

BH-7089-97 Adapter and Pad



Type NSP

Also See BH-7089-97R
Replacement Pad: BH-7235-90A

1-1/4" PIN OD
Rectangle Adapter Base & Pad Assembly for Forward Lifts
1-1/4" Pin Diameter

BH-7089-97R Adapter and Rectangle Pad



Type NSP

Available for use on Forward Lifts for those who prefer a thicker, longer lasting pad.

Replacement Pad: BH-7101-00

1.575" (40MM) PIN OD • 1-1/2" PIN LENGTH

Nesting Style Height Extensions

Type NS

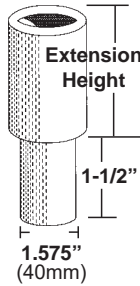
BH-7548-003 (Ref V12TP-4303) • 2" Extension
BH-7548-001 (Ref V12TP-4301) • 4-1/2" Extension
BH-7548-002 (Ref V12TP-4302) • 8-1/2" Extension

Height Extensions and Adapters For Gilbarco Lifts

*Available—See Manitowoc Lifts section



Did you know?

In-Ground Globe Lifts Are Available from SVI!

Simple!

It goes up.
It goes down.
When you want.
Every time.

Since 1928.
Now, it's your turn to own a Globe.



An SVI Brand Product Line

ENVIRONMENTALLY FRIENDLY AND SAFE TO OPERATE!
Operates off of Compressed Air and Non-Vegetable Based Fluid
Just Like That Used by the US Coast Guard

These models are exempt from Federal EPA regulation.

In-ground lifts are making a major resurgence due to their solid design and proven service life.

Nothing outperforms or costs less to operate than an in-ground lift. Get in, get one!

SINGLE-POST IN-GROUND FRAME CONTACT PASSENGER CAR LIFT

FS-10 8,000 LB. CAPACITY

Model FS-10AS SEMI-HYDRAULIC

Model FS-10BS FULL-HYDRAULIC

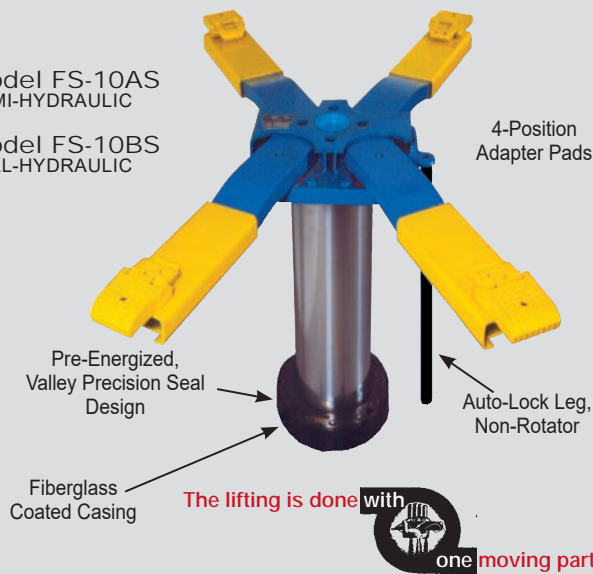

- Handles Most Domestic and Imported Models
- 4-Position Adapters Provide Excellent Undercar Accessibility
- Low Profile - 4" Road Clearance
- Ideal in Virtually Any Shop
- Great for Front End and Suspension Work

SPECIFICATIONS:

Capacity:	8,000 lbs. @ 150PSI (2,000 lbs. per Adapter)
Operation:	"AS" = Semi-Hydraulic or "BS" = Full-Hydraulic
Rise:	72"
Stroke:	68"
Displacement:	26 gallons
Initial Fill:	40 gallons "AS" and 50 gallons "BS"
Cylinder:	10-5/8" Diameter
Superstructure:	Solid Steel Bolster-Style and Low Profile Swing Arms
Adapters:	Ductile Iron, 4-Position Adjustable on Sliding Sleeves
Low Oil Control and Auto Lock Leg:	Supplied in Accordance with ANSI B153.1 Specifications

TWO-POST IN-GROUND FRAME CONTACT PASSENGER CAR LIFT

FSDT-28 12,000 LB. CAPACITY

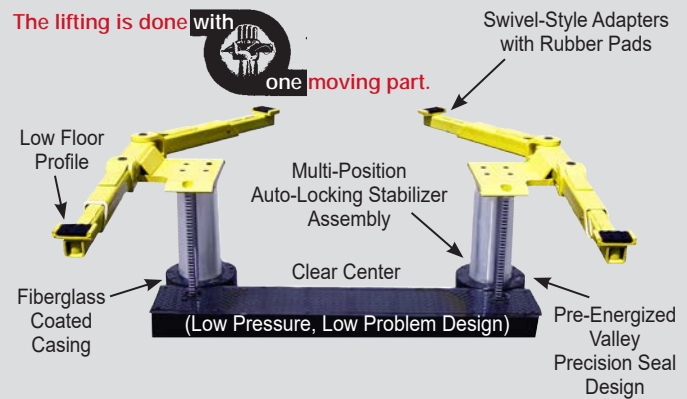

Model FSDT-28BS-N FULL-HYDRAULIC

Model FSDT-28BS-W FULL-HYDRAULIC

- Handles Most Domestic and Imported Models
- 360° Swivel Adapters
- Low Profile - 4-3/4" Road Clearance
- Ideal in Virtually Any Shop
- Great for Front End and Suspension Work

SPECIFICATIONS:

Capacity:	12,000 lbs. @ 150PSI (3,000 lbs. per Adapter)
Operation:	"BS" = Full-Hydraulic
Rise:	72" Floor to Top of the Adapter Pad without Extension
Plunger Centers:	57-1/2"
Displacement:	36 gallons
Initial Fill:	65 gallons
Cylinders:	8-1/2" Diameter
Superstructure:	Solid Steel Bolster-Style and Low Profile Swing Arms
Adapters:	360° Nesting Style, Swivel Adjustable on Sliding Sleeves
Low Oil Control and Auto Lock Leg:	Supplied in Accordance with ANSI B153.1 Specifications



Call SVI Today...

In-Ground Globe Lifts Are Available from SVI!

Simple!

It goes up.
It goes down.
When you want.
Every time.

Since 1928.
Now, it's your turn to own a Globe.



An SVI Brand Product Line

ENVIRONMENTALLY FRIENDLY AND SAFE TO OPERATE!
Operates off of Compressed Air and Non-Vegetable Based Fluid
Just Like That Used by the US Coast Guard

These models are exempt from Federal EPA regulation.

In-ground lifts are making a major resurgence due to their solid design and proven service life.

Nothing outperforms or costs less to operate than an in-ground lift. Get in, get one!

TWO-POST IN-GROUND
FRAME CONTACT PASSENGER CAR LIFT

FSR-28

8,000 LB.
CAPACITY

Model FSR-28BS
FULL-HYDRAULIC

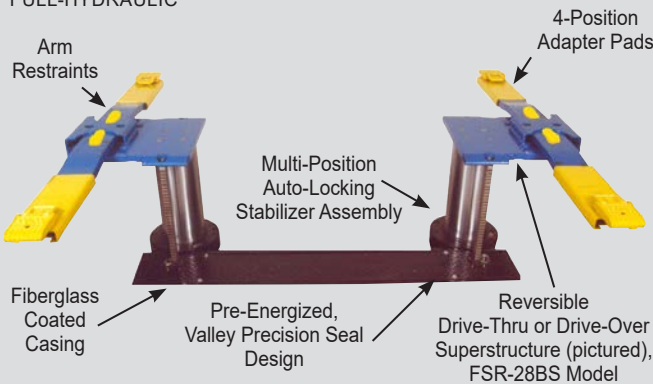

The lifting is done with one moving part.

- Handles Most Domestic and Imported Models
- 4-Position Adapters Provide Excellent Undercar Accessibility
- Low Profile - 4" Road Clearance
- Ideal in Virtually Any Shop
- Great for Front End and Suspension Work

SPECIFICATIONS:

Capacity: 8,000 lbs. @ 150PSI (2,000 lbs. per Adapter)
Operation: "BS" = Full-Hydraulic
Rise: 71-1/2" Floor to Top of the Adapter Pad
Plunger Center: 57-1/2"
Displacement: 36 gallons
Initial Fill: 65 gallons
Cylinder: 8-1/2" Diameter
Superstructure: Solid Steel Bolster-Style and Low Profile Swing Arms
Adapters: Ductile Iron, 4-Position Adjustable on Sliding Sleeves
Low Oil Control and Auto Lock Leg: Supplied in Accordance with ANSI B153.1 Specifications

TWO-POST IN-GROUND
FRAME CONTACT PASSENGER CAR LIFT

FS-28

8,000 LB.
CAPACITY

Model FS-28BS
FULL-HYDRAULIC

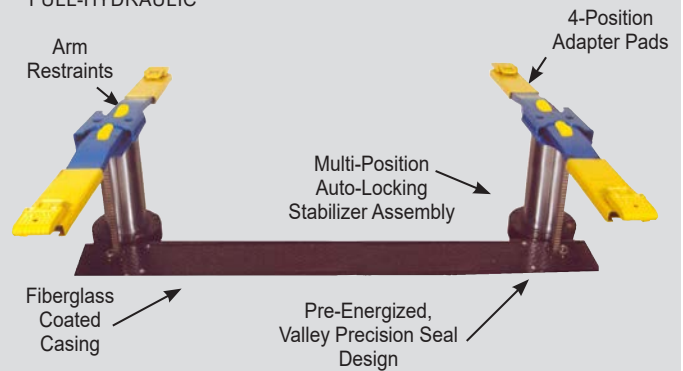

The lifting is done with one moving part.

- Handles Most Domestic and Imported Models
- 4-Position Adapters Provide Excellent Undercar Accessibility
- Low Profile - 4" Road Clearance
- Ideal in Virtually Any Shop
- Great for Front End and Suspension Work

SPECIFICATIONS:

Capacity: 8,000 lbs. @ 150PSI (2,000 lbs. per Adapter)
Operation: "BS" = Full-Hydraulic
Rise: 71-1/2" Floor to Top of the Adapter Pad
Plunger Center: 88"
Displacement: 36 gallons
Initial Fill: 65 gallons
Cylinder: 8-1/2" Diameter
Superstructure: Solid Steel Bolster-Style and Low Profile Swing Arms
Adapters: Ductile Iron, 4-Position Adjustable on Sliding Sleeves
Low Oil Control and Auto Lock Leg: Supplied in Accordance with ANSI B153.1 Specifications



Height Extensions and Adapters For Globe Lifts/Ford Smith

Please always confirm dimensions before ordering. Height Extensions and Adapters come in many different styles and dimensions. SVI is well-known as the adapter expert, specializing in top quality standard and custom adapters. SVI is your answer.

Additional Height Extensions for Globe Lifts and Ford Smith SLEEVE AND ADAPTER ASSEMBLIES - FOR MANY MODELS

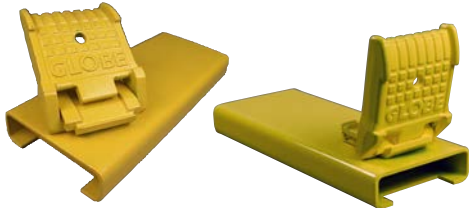

Sleeve and Adapter Assemblies

4-Position Frame Contact Adapters

Reversible Sleeves (Standard Feature)

The adapter supporting sleeve can easily be slipped off the swing arm and reversed. This provides even greater flexibility in reaching pick-up points on today's smaller vehicles.

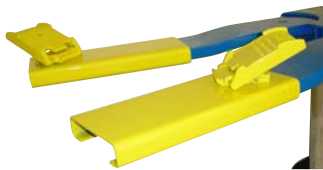

Standard 4-position adapters mean Globe lifts provide the industry's most versatility in reaching proper pick-up points on the vehicles you are lifting.

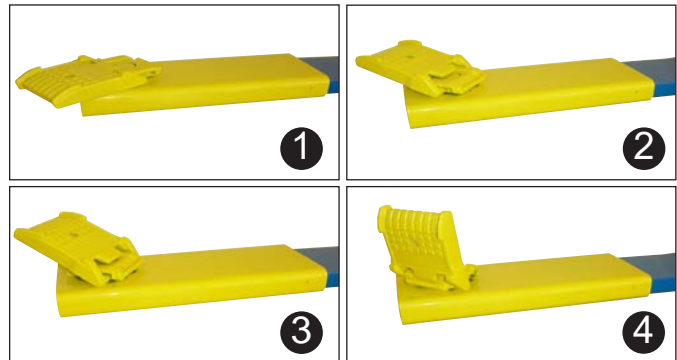

OPTIONAL Height Extensions Available

Slide height extensions easily onto the Frame Contact adapter while in the upright position to provide more versatility in reaching the proper pick-up points.



BH-9420-09 (Ref C-34354, C-034354-001 Wayne, B-34355)
Sleeve and Adapter Assembly
17-1/4" Long

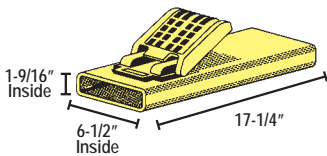

BH-9420-09L
(Ref 101655, 34354-011)
Sleeve and Adapter Assembly
22-1/4" Long

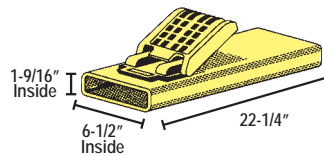

BH-9420-09N
(Ref 34354-008)
Sleeve and Adapter Assembly
17-1/4" Long • Narrow

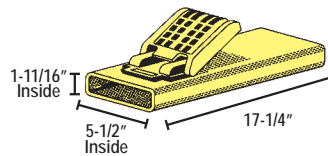

BH-9420-09LT
Sleeve and Adapter Assembly
22-1/4" Long • Taller

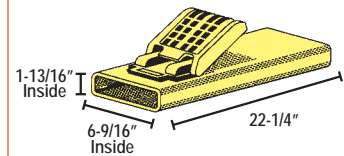

BH-9420-11 (Ref 100773, C-34355)
Lift Pad Only

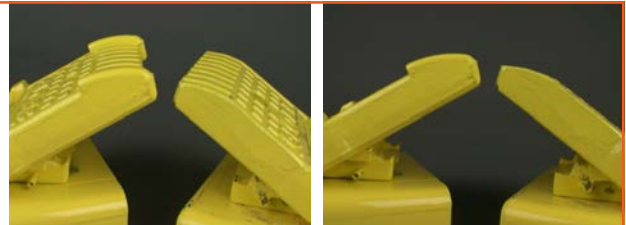

SVI Part #	Ref #	Description / Details
BH-9420-09	C-34354 100776	Sleeve and Adapter Assembly 17-1/4" Long
BH-9420-09L	101655 34354-011	Sleeve & Adapter Assembly 22-1/4" Long
BH-9420-09H		Sleeve & Adapter for 10K
BH-9420-09LT		Sleeve & Adapter Assembly 22-1/4" Long -Taller

SVI Part #	Ref #	Description / Details
BH-9420-09N	34354-008	Sleeve & Adapter Assembly - Narrow
BH-9420-09P	40847	Sleeve & Adapter Assembly 10" Long
BH-9420-09S	ACC-174 43895-1	Sleeve with Spin-Up with Round Pad Adapter 20" Long
BH-9420-09T	43849	Truck Sleeve & Spin-Up 23" Long
BH-9420-96	34354-016	Sleeve & Adapter Assembly 3/8" Thick Heavy Duty



Height Extensions and Adapters For Globe Lifts/Ford Smith

Please always confirm dimensions before ordering. Height Extensions and Adapters come in many different styles and dimensions. SVI is well-known as the adapter expert, specializing in top quality standard and custom adapters. SVI is your answer.

Additional Height Extensions for Globe Lifts and Ford Smith FOR LIFTS WITH FLIP-UP STYLE ADAPTERS - MANY MODELS

HIGH PROFILE VERSION
BH-9420-09T (Ref 43849) **Truck Sleeve and Spin-Up Pad Adapter**
 Features BH-7250-02 Pad (4-1/2" OD Top). Threaded segment is 4-1/2" Long.

LOW PROFILE VERSION
BH-9420-09S (Ref ACC-174, 43895-1) **Sleeve with Spin-Up Pad Adapter**
 Features BH-7450-02 Pad (4-15/16" OD Top). Threaded segment is 2-1/2" long, and female threaded segment is welded directly on top of the sleeve.

BH-9420-09T High Profile Version Pictured

SOM Drop-On Extension Without Pad
SOMP Drop-On Extension With Pad

Drop-On Height Extension for Flip-Up
BH-9420-13 9" Tall • SOM Style without Pad
BH-9420-13P 9" Tall • SOMP Style with Rectangle Pad

NOTE: Also available as wide style GMT Adapters for use with 2019, 2020, and newer Chevrolet 1500 Silverado and GMC Sierra Trucks.

Inside Dimensions:
5-3/4" Wide

Inside Dimensions:
5-3/4" x 1-7/16"

Fits over Flip Up Adapters

BH-9420-13 Type SOM BH-9420-13P Type SOMP

For SOMP, Replacement Rubber Pad: BH-9900-10 (3" x 5" x 3/8")

SOGP Drop-On Extension - FIXED Height
SOGPA Drop-On Extension - ADJUSTABLE Height

Slip-On Height Extension
BH-9420-25 8-1/2" Fixed Height • SOGP Style
BH-9420-26 7"-10" Adjustable Height • SOGPA Style

Pictured with Sleeve/Adapter, Sold Separately

Opening Dimensions:
5-11/16" x 1-1/2"

Fits over Flip Up Adapters

Type SOGP Type SOGPA
 BH-9420-25 BH-9420-26

Replacement Octagon Rubber Pad: BH-7225-01 or Heavy Duty BH-7225-01X

SONRW Narrow Drop-On Extension
For Close to Frame Obstructions
BH-9420-27 • 9" Drop-On Height Extension with Rectangle Pad

Fits over Flip Up Adapters

Avoids denting or puncturing fuel tank and smashing brake lines. Commonly sold for use on the rear of late model trucks and SUVs.

Replaceable Pad: BH-9755-50-1



Height Extensions and Adapters For Globe Lifts / Ford Smith

Please always confirm dimensions before ordering. Height Extensions and Adapters come in many different styles and dimensions. SVI is well-known as the adapter expert, specializing in top quality standard and custom adapters. SVI is your answer.





MANY MORE AVAILABLE!

See common adapters and pads at the beginning of this catalog:
Height Extensions & Adapters By Type / Style
Includes Nesting Style Height Extensions, Nesting Pad Adapters,
Slip-On Style, Drop-On Style, Adjustable and Fixed Adapters, and more!



Additional Height Extensions for Globe Lifts and Ford Smith FOR LIFTS WITH FLIP-UP STYLE ADAPTERS - MANY MODELS

**TYPE
GMT**

7" Wide
Lifting Area

Specialty Lift Adapters

FOR 2019, 2020 AND NEWER

Chevrolet 1500 Silverado and GMC Sierra Truck Models



Made in the USA



Rear
BH-9420-13GMT-3
BH-9420-13GMT-4



7" Wide Lifting Area

Front
BH-9420-13GMT-1
BH-9420-13GMT-2



Inside Dimensions:
5-3/4" x 1-7/16"

Kit for Flip-Up Adapters
BH-9420-13GMT

BH-9420-13GMT	Specialty Drop-On Height Extension KIT for Flip-Up (KIT includes (2) Front and (2) Rear)
BH-9420-13GMT-1	Flip-Up Height Ext - Front
BH-9420-13GMT-2	Flip-Up Height Ext - Front (Set of 2)
BH-9420-13GMT-3	Flip-Up Height Ext - Rear
BH-9420-13GMT-4	Flip-Up Height Ext - Rear (Set of 2)



Example Pic of Other GMT Adapters (Not a Globe Lift Pictured)

On-going SVI engineering and production activities are occurring to provide lifting adapters for many makes and models of lifts so the new 2019, 2020 and after GM Trucks can be correctly accommodated on virtually any lift. SVI employs a professional staff of engineers who are well-suited to design products to satisfy the requirements and internal self testing is also routinely performed, where applicable.



Height Extensions and Adapters For Globe Lifts / Ford Smith

Please always confirm dimensions before ordering. Height Extensions and Adapters come in many different styles and dimensions. SVI is well-known as the adapter expert, specializing in top quality standard and custom adapters. SVI is your answer.





MANY MORE AVAILABLE!

See common adapters and pads at the beginning of this catalog:
Height Extensions & Adapters By Type / Style
Includes Nesting Style Height Extensions, Nesting Pad Adapters,
Slip-On Style, Drop-On Style, Adjustable and Fixed Adapters, and more!



Additional Height Extensions for Globe Lifts and Ford Smith FOR VARIOUS MODELS

1-1/4"-7 THREADS • SCREW-UP ADAPTER AND PAD
Screw Adapter with Slip-Over Square Pad
BH-7250-03 (Ref FS-207526, 207526, 203556, FS-203556)



1-1/4"-7
Threads



BH-7250-03P
Pad Dimensions
4-1/2" x 4-1/2"

Replacement Pad—See BH-7250-03P

FOR GLOBE / FORD SMITH
Slip-Over Square Rubber Pad
(Ref 208512, FS-208512)
BH-7250-03P 1 Pad

4-1/2" x 4-1/2"
1" Thick



1-3/8" (35MM) PIN OD
Drop-In Nesting Style Adapter with Slip-Over Square Pad with
1-3/8" Diameter Pin for Globe Lifts GV-10

BH-7256-20 Individual Adapter & Pad
BH-7479-55 (Ref 5715365) Replacement Pad Only



1-3/8" Type NSP

BH-7090-10
(Ref 5746390, 66501)
3" Nesting Style Height
Extension 1-3/8" (35 mm) Pin



Type NS
3" 1-3/8"

BH-7090-13
(Ref 81691, 27982, 66502)
6" Nesting Style Height
Extension 1-3/8" (35 mm) Pin



Type NS
6" 1-3/8"

OPENING DIMENSIONS: 3-3/8" X 1-5/16"
Fixed Slip-On Height Extension with Rectangle Pad
Fits over Flat Rectangular Pad BH-7250-01

BH-7253-15 • 3" Extension
BH-7253-16 • 4" Extension
BH-7253-17 • 5" Extension
BH-7250-05 • 6" Extension
BH-7253-19 • 7" Extension
BH-7253-20 • 8" Extension
BH-7253-21 • 9" Extension
BH-7253-22 • 10" Extension

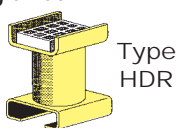

Type HDR
Opening Dimensions:
3-3/8" x 1-5/16"
Replacement Pad: BH-7205

OPENING DIMENSIONS: 3-3/8" X 1-5/16"
Slip-On Height Extension LDR Style

BH-7253-10 • 3" Extension
BH-7253-11 • 4" Extension
BH-7253-12 • 5" Extension
BH-7253-13 • 6" Extension
BH-7253-14 • 7" Extension

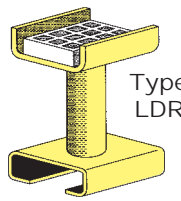

Type LDR
Opening Dimensions:
3-3/8" x 1-5/16"

Replacement Pad: BH-7205



Height Extensions and Adapters For Globe Lifts / Ford Smith

Please always confirm dimensions before ordering. Height Extensions and Adapters come in many different styles and dimensions. SVI is well-known as the adapter expert, specializing in top quality standard and custom adapters. SVI is your answer.



MANY MORE AVAILABLE!
 See common adapters and pads at the beginning of this catalog:
 Height Extensions & Adapters By Type / Style
 Includes Nesting Style Height Extensions, Nesting Pad Adapters,
 Slip-On Style, Drop-On Style, Adjustable and Fixed Adapters, and more!



Additional Height Extensions for Globe Lifts and Ford Smith FOR VARIOUS MODELS

OPENING DIMENSIONS: 3-3/8" X 1-5/16"
 Adjustable Height Extension With Rectangle Pad

BH-7253-23 • 4"–6" Adjustable
 BH-7253-24 • 6"–9-1/2" Adjustable

Opening Dimensions:
3-3/8" x 1-5/16"

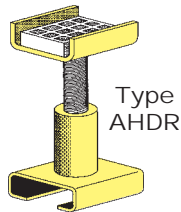

Type AHDR

Replacement Pad—See BH-7205

OPENING DIMENSIONS: 3-3/8" X 1-5/16"
 Slip-On Narrow Height Extension for Close to Frame Obstructions

BH-7253-46 • 3" Extension
 BH-7253-47 • 6" Extension
 BH-7253-48 • 9" Extension

Adjustable version also available.

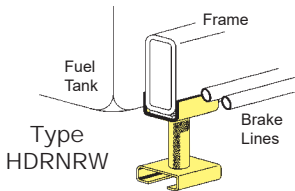

Type HDRNRW

Opening Dimensions:
3-3/8" x 1-5/16"

Replacement Pad: BH-9755-50-1

OPENING DIMENSIONS: 3-3/8" X 1-5/16"
 Adjustable Slip-On Narrow Height Extension for Close to Frame Obstructions

BH-7253-52 • 4"–6" Adjustable
 BH-7253-53 • 6"–9" Adjustable

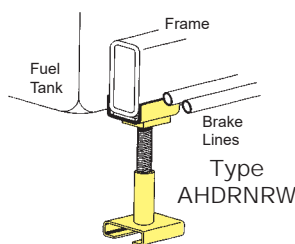

Type AHDRNRW

Opening Dimensions:
3-3/8" x 1-5/16"

Replacement Pad: BH-9975-50-1

OPENING DIMENSIONS: 3-3/8" X 1-5/16"
 Slip-On Height Extension • (No Pad) LDM Style

BH-7250-70 3" Extension
 BH-7250-71 6" Extension
 BH-7250-72 9" Extension

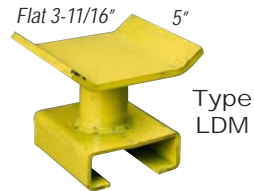

Type LDM

Opening Dimensions:
3-3/8" x 1-5/16"

Flat 3-11/16" 5"

OPENING DIMENSIONS: 4-9/16" X 1-3/16"
 Slip-On Height Extension with Rectangle Pad
Fits over BH-7250-01 Rubber Pad
 For Globe AFO Models

BH-7253-27 • 3" Extension
 BH-7253-28 • 4" Extension
 BH-7253-29 • 5" Extension
 BH-7253-30 • 7" Extension
 BH-7253-31 • 8" Extension
 BH-7253-32 • 9" Extension
 BH-7253-33 • 10" Extension

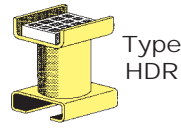

Type HDR

Opening Dimensions:
4-9/16" x 1-3/16"

Replacement Pad: BH-7205

OPENING DIMENSIONS: 4-9/16" X 1-3/16"
 Adjustable Slip-On Height Extension with Rectangle Pad
Fits over BH-7250-01 Rubber Pad
 For Globe AFO Models

BH-7253-25 • 4"–6" Adjustable
 BH-7253-26 • 6"–9-1/2" Adjustable

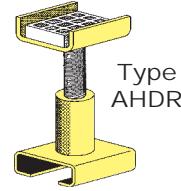

Type AHDR

Opening Dimensions:
4-9/16" x 1-3/16"

Replacement Pad: BH-7205

Height Extensions and Adapters For Globe Lifts / Ford Smith

Please always confirm dimensions before ordering. Height Extensions and Adapters come in many different styles and dimensions. SVI is well-known as the adapter expert, specializing in top quality standard and custom adapters. SVI is your answer.

MANY MORE AVAILABLE!
See common adapters and pads at the beginning of this catalog:
Height Extensions & Adapters By Type / Style
Includes Nesting Style Height Extensions, Nesting Pad Adapters,
Slip-On Style, Drop-On Style, Adjustable and Fixed Adapters, and more!

Additional Height Extensions for Globe Lifts and Ford Smith FOR VARIOUS MODELS

OPENING DIMENSIONS: 4-9/16" X 1-3/16"
Fixed Slip-On Height Extension with Octagon Pad
Fits over BH-7250-01 Rubber Pad
For Globe AFO Models

BH-7250-07 • 6" Extension

*Other Heights May Be Available
Contact SVI Today.*

Type LDH

Opening Dimensions:
4-9/16" x 1-3/16"

Replacement Pad: BH-7235-90A

OPENING DIMENSIONS: 4-9/16" X 1-3/16"
Adjustable Slip-On Height Extension with Octagon Pad
Fits over BH-7250-01 Rubber Pad
For Globe AFO Models

BH-7250-06 • 6"-9.5" Adjustable

Type ALDH

Opening Dimensions:
4-9/16" x 1-3/16"

Replacement Pad: BH-7225-01

OPENING DIMENSIONS: 4-9/16" X 1-3/16"
Fixed Slip-On Height Extension
for Close to Frame Obstructions
*Fits over BH-7250-01
Rectangle Pad*

Fuel Tank

Frame

Brake Lines

Type HDRNRW

Opening Dimensions:
4-9/16" x 1-3/16"

Replacement Pad: BH-9755-50-1

BH-7253-49 3" Adapter
BH-7253-50 6" Adapter
BH-7253-51 9" Adapter

OPENING DIMENSIONS: 4-9/16" X 1-3/16"
Adjustable Slip-On Height Extension
for Close to Frame Obstructions
*Fits over BH-7250-01
Rectangle Pad*

Fuel Tank

Frame

Brake Lines

Adjustable Adapter

Type AHDRNRW

Opening Dimensions:
4-9/16" x 1-3/16"

Replacement Pad: BH-9755-50-1

BH-7253-54 4" to 6"
BH-7253-55 6" to 9"

OPENING DIMENSIONS: 4-9/16" X 1-3/16"
Slip-On Height Extension • (No Pad) LDM Style
*Fits over BH-7250-01
Rectangle Pad*

Flat 3-11/16" 5"

Type LDM

Opening Dimensions:
4-9/16" x 1-3/16"

BH-7253-43 3" Extension
BH-7253-44 6" Extension
BH-7253-45 9" Extension



Height Extensions and Adapters For Grand Lifts

Please always confirm dimensions before ordering. Height Extensions and Adapters come in many different styles and dimensions. SVI is well-known as the adapter expert, specializing in top quality standard and custom adapters. SVI is your answer.



MANY MORE AVAILABLE!
 See common adapters and pads at the beginning of this catalog:
 Height Extensions & Adapters By Type / Style
 Includes Nesting Style Height Extensions, Nesting Pad Adapters,
 Slip-On Style, Drop-On Style, Adjustable and Fixed Adapters, and more!



Additional Height Extensions for Grand Lifts FOR VARIOUS MODELS

Note: Grand has made several adapter changes over the years. Please confirm dimensions before ordering.



5-1/2" Screw-On Height Extension
 BH-7375-01
 (ref HA-1)



*Also See
 BH-7090-85
 SURX Series*

*Top Rectangle Dimensions: 4" x 3.5"
 8" Long Screw • 1-3/8-6 Threads*

Screw Up Height Extension with 4" x 4.5" Rectangle Slip On Pad
Please Confirm Threads Before Ordering. This Adapter Style is Available in Various Threads—Ask SVI for type SURX adapters!

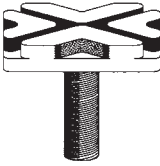

1-3/8"-6 Threads
 Features BH-7750-02 Rubber Pad

BH-7090-85	4" Adapter
BH-7090-86	5" Adapter
BH-7090-87	6" Adapter
BH-7090-88	7" Adapter
BH-7090-89	8" Adapter

Type SURX



BH-7375-02N
6" Slip-On Height Extension
 New Style

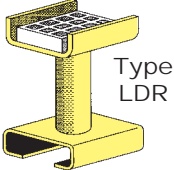

Type LDR

*Opening Dimensions:
 4" x 1"*

Replacement Pad: BH-7205

Slip-On Height Extension with Rectangle Rubber Pad
 Old Style

BH-7376-10	3" Extension
BH-7376-11	4" Extension
BH-7376-12	5" Extension
BH-7375-02	6" Extension
BH-7376-14	7" Extension

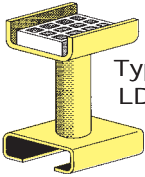

Type LDR

*Opening Dimensions:
 4-1/4" x 1-1/8"*

Fits over Spin-Up with X-Pattern Rubber Pad

Replacement Pad: BH-7205



Height Extensions and Adapters For Hofmann

Please always confirm dimensions before ordering. Height Extensions and Adapters come in many different styles and dimensions. SVI is well-known as the adapter expert, specializing in top quality standard and custom adapters. SVI is your answer.



MANY MORE AVAILABLE!
 See common adapters and pads at the beginning of this catalog:
 Height Extensions & Adapters By Type / Style
 Includes Nesting Style Height Extensions, Nesting Pad Adapters,
 Slip-On Style, Drop-On Style, Adjustable and Fixed Adapters, and more!

Additional Height Extensions for Hofmann Lifts FOR VARIOUS MODELS

FOR HOFMANN
Bolt-On Round Rubber Pad
 (Ref 1701-261)
BH-7276-00 1 Pad



4-5/8"
Round

4.625

.900



Height Extensions and Adapters For Hydra-Lift

Please always confirm dimensions before ordering. Height Extensions and Adapters come in many different styles and dimensions. SVI is well-known as the adapter expert, specializing in top quality standard and custom adapters. SVI is your answer.



MANY MORE AVAILABLE!
 See common adapters and pads at the beginning of this catalog:
 Height Extensions & Adapters By Type / Style
 Includes Nesting Style Height Extensions, Nesting Pad Adapters,
 Slip-On Style, Drop-On Style, Adjustable and Fixed Adapters, and more!



Additional Height Extensions for Hydra-Lift Lifts

FOR VARIOUS MODELS

1-1/4"-7 THREADS
 BH-7287-02 (Ref 28191)
Low Profile Adapter
 for Hydra-Lift
(Does not use a pad.)

Top:
4.5" x 5"

*1-1/4"-7
Threads*

1-1/4"-7 THREADS
 BH-7287-59 (Ref 30)
Optional High Lift Adapter
 for Hydra-Lift
(Does not use a pad.)

Top:
4.5" x 5"



*1-1/4"-7
Threads*

**2" x 6" Nesting Style
 Height Extension**
 BH-7291-45 (Ref 28404)





Height Extensions and Adapters For Launch Lifts

Please always confirm dimensions before ordering. Height Extensions and Adapters come in many different styles and dimensions. SVI is well-known as the adapter expert, specializing in top quality standard and custom adapters. SVI is your answer.



MANY MORE AVAILABLE!

See common adapters and pads at the beginning of this catalog:
 Height Extensions & Adapters By Type / Style
 Includes Nesting Style Height Extensions, Nesting Pad Adapters,
 Slip-On Style, Drop-On Style, Adjustable and Fixed Adapters, and more!



Additional Height Extensions for Launch Lifts

FOR VARIOUS MODELS including TLT210 SERIES, TLT211 SERIES

2-3/8" NUT / COLLAR / PIN OD



Pin Diameter
2-3/8"

Pin Length
1-1/2"

Height Extension Kit for Challenger CL9/CL10

Pin Diameter 2-3/8" • Pin Length 1-1/2"

BH-7234-119 (Ref 10315) KIT COMES WITH:
 3" Tall Height Extension - Qty (4)
 6" Tall Height Extension - Qty (2)
 Qty (2) Hanging Brackets With Hardware

SVI Part #	OEM #	Pin OD	Pin Length	Description
BH-7234-119	10315	2-3/8"	1-1/2"	Height Extension Kit
BH-7234-119A	B2206-3	2-3/8"	1-1/2"	3" Height Extension
BH-7234-119B	B2206-6, CLF10313	2-3/8"	1-1/2"	6" Height Extension
BH-7234-119C	B2209			Hanging Bracket
<i>Included with Kit</i>				Pan Head Screws

2-3/8" NUT/COLLAR OD
 BH-7232-98 (Ref B2260 / B2250)
 Drop-In Adapter /
 Foot Pad Assembly
 with Round Rubber Pad

Works well with
 BH-7234-119 (ref 10315)
 Height Extension Kit

Replacement Pad: BH-7232-93



5-7/16" OD Pad

1-2/5" Pin Length

2.358" Pin Diameter

2-3/8" NUT/COLLAR OD
 BH-7232-01UPB (Ref B2270)
 Drop-In Adapter /
 Foot Pad Assembly
 with Urethane Pad

Works well with
 BH-7234-119 (ref 10315)
 Height Extension Kit

Replacement Pad: BH-7232-01U (Ref A1104H, Urethane) or BH-7232-01OHD (Rubber)



Top • 4-1/8" ID

1-2/5" Pin Length

2.358" Pin Diameter

2-3/8" (60 MM) NUT / COLLAR OD • 1-3/5" LONG PIN
 Specialty Wide Adapter for 2019, 2020 and newer Chevrolet 1500 Silverado and GM Sierra Trucks - 2" Pin Diameter
 Features 7" Wide Lifting Area

BH-7232-98GMT-1 (Ref B2280x) (1) Adapter Base and Pad
 BH-7232-98GMT (Ref B2280PRx) (2) Adapter Bases and Pads

Features BH-7542-75P Rectangle Rubber Pad

TYPE GMT

7" Wide Lifting Area



Important: Confirm Dimensions

2.358" Nut Diameter

Standard Snap-In Urethane Pad (Ref A1104-H, A1104H)
 4-11/32" x 4" • 2 Snap-In Pegs On Bottom

BH-7232-01U 1 Pad — Sold Individually

The Better Choice—Does Not Curl Up like Urethane:
 Heavy Duty Bolt-On Rubber Arm Pad ▶
 An SVI Exclusive

BH-7232-01OHD 1 Pad
 BH-7232-01OHD-4 Set of 4 Pads

3/8" Thick 2-Ply



Page

More Styles Available—See common "Height Extensions & Adapters By Type / Style" at the beginning of this catalog! 115



Height Extensions and Adapters For Magnum Lifts

Please always confirm dimensions before ordering. Height Extensions and Adapters come in many different styles and dimensions. SVI is well-known as the adapter expert, specializing in top quality standard and custom adapters. SVI is your answer.



MANY MORE AVAILABLE!
 See common adapters and pads at the beginning of this catalog:
 Height Extensions & Adapters By Type / Style
 Includes Nesting Style Height Extensions, Nesting Pad Adapters,
 Slip-On Style, Drop-On Style, Adjustable and Fixed Adapters, and more!

Additional Height Extensions for Magnum Lifts

FOR VARIOUS MODELS

Also see Wheeltronic

FOR MAGNUM LIFTS
 Fixed Slip-On Height Ext.
 with Rectangle Pad
 BH-7496-1005 • 5" Extension
 BH-7496-1006 • 6" Extension



Opening Dimensions:
4-1/4" x 3/4"

Type HDR

Replacement Pad: BH-7205

Height Extensions and Adapters For Manitowoc / Gilbarco Lifts

Please always confirm dimensions before ordering. Height Extensions and Adapters come in many different styles and dimensions. SVI is well-known as the adapter expert, specializing in top quality standard and custom adapters. SVI is your answer.

MANY MORE AVAILABLE!
*See common adapters and pads at the beginning of this catalog:
 Height Extensions & Adapters By Type / Style
 Includes Nesting Style Height Extensions, Nesting Pad Adapters,
 Slip-On Style, Drop-On Style, Adjustable and Fixed Adapters, and more!*

Additional Height Extensions for Manitowoc Lifts / Gilbarco Lifts

For ATF-55, ATF-70, ATF-70B Above the Floor (ATF) Models

<p>Pick-Up Pad Height Extension Adapter (1) BH-7352-01 (Ref K34155, R18222) Individual Adapter (1)</p> <ul style="list-style-type: none"> For Gilbarco ATF-55 and ATF-70 Above-Ground Lifts Each Supports 1,750 lbs. Adapters can be Rotated 360° for Easy Positioning Adapters Extend for 5" to 6-1/2" Above the Top of the Swing Arm. 	<p>Pick Up Pad Support Adapter for Gilbarco ATF-55, ATF-70, ATF-70B BH-7352-02 (Ref R18220-51)</p> <p style="text-align: center;">1-3/8"-4 Acme Threads</p>	<p>Pad for Gilbarco ATF-55, ATF-70, ATF-70B BH-7352-03 (Ref K34314)</p> <div style="text-align: right; margin-top: 10px;"> </div>
---	---	---

Additional Height Extensions for Manitowoc Lifts / Gilbarco Lifts

For CFF-70, CFF-70N, CFF-70S, CFF-90, CFF-10,000, CBT-70, CBT-90, CL-9000

<p>4" Tall Height Extension Adapters (Ref K93216, B-100-70) BH-7352-18 Set of 4 Height Extensions BH-7352-18A (1) Individual Height Extension</p> <p>For Use on Models: CFF-70, CFF-70N, CFF-70S, CFF-90, CFF-10,000, CBT-70, CBT-90, and CL-9000</p> <p>Adapters lock onto lift pads.</p>	<p>8" Height Extension Adapter (1) (Ref B-100-69, K93218) B-100-69 (1) Individual Adapter</p> <p>Sold individually. If you need a full kit of 4, just let us know.</p> <p>Adapters lock onto lift pads.</p>
<p>Lift Pad Base for Manitowoc / Gilbarco (Ref B-100-62) BH-7350-44 1 Lift Pad Base</p> <p>For Use on Models: CFF-70, CFF-70N, CFF-70S, CFF-90, CFF-10,000, CBT-70, CBT-90, and CL-9000</p>	<p>Rubber Arm Pad for Manitowoc / Gilbarco (Ref K93223) BH-7350-00 1 Arm Pad</p> <p>For Use on Models: CFF-70, CFF-70N, CFF-70S, CFF-90, CFF-10,000, CBT-70, CBT-90, and CL-9000</p> <div style="text-align: right; margin-top: 10px;"> </div>



Height Extensions and Adapters For Manitowoc / Gilbarco Lifts

Please always confirm dimensions before ordering. Height Extensions and Adapters come in many different styles and dimensions. SVI is well-known as the adapter expert, specializing in top quality standard and custom adapters. SVI is your answer.

Additional Height Extensions for Manitowoc Lifts / Gilbarco Lifts

For LIFTS WITH FLIP-UP STYLE ADAPTERS - MANY MODELS

SOM Drop-On Extension Without Pad
SOMP Drop-On Extension With Pad

Drop-On Height Extension for Flip-Up
 BH-9380-02 9" Tall • SOM Style without Pad
 BH-9380-03 9" Tall • SOMP Style with Rectangle Pad

NOTE: Also available as wide style GMT Adapters for use with 2019, 2020, and newer Chevrolet 1500 Silverado and GMC Sierra Trucks.

For SOMP, Replacement Rubber Pad: BH-9900-10 (3" x 5" x 3/8")

SOGP Drop-On Extension - FIXED Height
SOGPA Drop-On Extension - ADJUSTABLE Height

Slip-On Height Extension
 BH-9380-04 8-1/2" Fixed Height • SOGP Style
 BH-9380-05 7"-10" Adjustable Height • SOGPA Style

Pictured with Sleeve/Adapter, Sold Separately

Replacement Octagon Rubber Pad: BH-7225-01 or Heavy Duty BH-7225-01X

SONRW Narrow Drop-On Extension
 For Close to Frame Obstructions

BH-7380-06 • 9" Drop-On Height Extension with Rectangle Pad

Replaceable Pad: BH-9900-10

Fits over Flip Up Adapters
 Avoids denting or puncturing fuel tank and smashing brake lines.
 Commonly sold for use on the rear of late model trucks and SUVs.

GMT Specialty

Specialty Wide Adapter for 2019, 2020 and newer Chevrolet 1500 Silverado and GM Sierra Trucks

Features 7" Wide Lifting Area

BH-9380-10GMT Flip-Up Adapter Height Ext. KIT (Set of 4—(2) Front and (2) Rear)

BH-9380-10GMT-1 FRONT Flip-Up Height Extension (1)
 BH-9380-10GMT-2 FRONT Flip-Up Height Extensions (Set of 2)
 BH-9380-10GMT-3 REAR Flip-Up Height Extension (1)
 BH-9380-10GMT-4 REAR Flip-Up Height Extensions (Set of 2)

Fits over Flip Up Adapters
 Opening Dimensions: 5-5/8" x 1-1/2"



Height Extensions and Adapters For Mohawk Lifts

Please always confirm dimensions before ordering. Height Extensions and Adapters come in many different styles and dimensions. SVI is well-known as the adapter expert, specializing in top quality standard and custom adapters. SVI is your answer.



MANY MORE AVAILABLE!

See common adapters and pads at the beginning of this catalog:
 Height Extensions & Adapters By Type / Style
 Includes Nesting Style Height Extensions, Nesting Pad Adapters,
 Slip-On Style, Drop-On Style, Adjustable and Fixed Adapters, and more!



Additional Height Extensions for Mohawk Lifts FOR VARIOUS MODELS

1-1/8" PIN OD • 2-1/4" LONG PIN
 Nesting Style Adapter with Pad - 1-1/8" Pin Dia.
****Alternative Pad to Steel Teeth Pad (Ref 025-002-035)**
 For use with System 1A, others

BH-7340-11 Adapter with Pad
 BH-7101-00 Replacement Pad Only

Alternative to:
 BH-7341-58 Steel Tooth Pad
 (ref 025-002-035) Not Shown



1-1/8" PIN OD • 2-1/8" LONG PIN
 1-1/2" Riser Nesting Style Adapter with Pad - 1-1/8" Pin Dia.
 For use with System 1A, others

BH-7340-40 Adapter with Pad 1-1/2" Riser
 BH-7101-00 Replacement Pad Only



1-1/8" PIN OD • 2-1/4" LONG PIN
 Specialty Wide Adapter for 2019, 2020 and newer Chevrolet 1500 Silverado and GM Sierra Trucks - 1-1/8" (35 mm) Pin Dia.
 Features 7" Wide Lifting Area. 1-1/8" Pin dia. x 2-1/4" Long Pin

BH-7341-58GMT-1 (1) Adapter Base with Pad
 BH-7341-58GMT Adapter Base with Pad (Set of 2)
 BH-7542-75P Replacement Pad Only
 BH-7542-75P-4 Replacement Pads (Set of 4)

TYPE GMT
 7" Wide Lifting Area



Pin: 1-1/8" Dia. x 2-1/4" Long

Nesting Style Narrow Top with 1-1/8" Pin Diameter
For close to frame obstructions. For use on the rear of late model trucks. Avoids denting or puncturing fuel tank and smashing brake lines. Adapter has a 4-1/2" x 3" rectangular top formed from heavy 3/16" and 3/8" steel plate with a replaceable rubber pad.

BH-7091-59 Nesting Adapter (Narrow Top) with Pad 1-1/8" Pin
 BH-9900-10A Replacement Rubber Pad Only

1-1/8" PIN OD
 Type NSPNRW
 Narrow

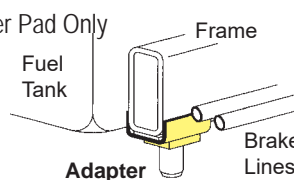

Adapter

1-1/8" PIN OD • 2-1/4" LONG PIN
 Nesting Style Height Extension - 1-1/8" Pin Dia.

BH-7340-12 • 3" Extension (Ref 025-002-127)
 BH-7340-13 • 4" Extension
 BH-7340-14 • 5" Extension
 BH-7340-15 • 6" Extension (Ref 025-002-128)

Also See BH-7340-15BK (ref 025-002-026)
 Height Extension Bracket for 1-1/8" Adapters

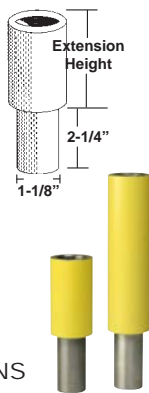

Type NS

1-1/8" PIN DIAMETER • 2-1/4" LONG PIN
 Specialty Wide Adapter for 2019, 2020 and newer Chevrolet 1500 Silverado and GM Sierra Trucks - 1-1/8" (35 mm) Pin Dia.
 Features 7" Wide Lifting Area. 1-1/8" Pin dia. x 2-1/4" Long Pin

BH-7341-58GMT-1 (1) Adapter Base with Pad
 BH-7341-58GMT Adapter Base with Pad (Set of 2)

Features BH-7542-75P Rectangle Rubber Pad

TYPE GMT
 7" Wide Lifting Area



Pin: 1-1/8" Dia. x 2-1/4" Long



Height Extensions and Adapters For Mohawk Lifts

Please always confirm dimensions before ordering. Height Extensions and Adapters come in many different styles and dimensions. SVI is well-known as the adapter expert, specializing in top quality standard and custom adapters. SVI is your answer.

MANY MORE AVAILABLE!
 See common adapters and pads at the beginning of this catalog:
 Height Extensions & Adapters By Type / Style
 Includes Nesting Style Height Extensions, Nesting Pad Adapters,
 Slip-On Style, Drop-On Style, Adjustable and Fixed Adapters, and more!

Additional Height Extensions for Mohawk Lifts FOR VARIOUS MODELS

1-3/8" PIN OD X 3-1/4" LONG PIN
Adapter with Rubber Pad - 1-3/8" Pin Diameter
 For use with Mohawk LMF-12, TP15, others.
****Alternative Pad to Steel Teeth Pad (Ref 012-012-047x)**
 Must buy 2 or 4 to change over.

BH-7340-29 Adapter with Rubber Pad
 BH-7340-29P Rubber Arm Pad Only
 4-1/2" x 6" x 3/8" Pad

Alternative to:
 BH-7340-23 Steel Tooth Pad
 (ref 012-012-047) Not Shown

1-3/8" PIN OD X 3-3/4" LONG PIN
Adapter with Rubber Pad for Mohawk - 1-3/8" Pin Diameter
 Must buy 2 or 4 to change over.

BH-7340-26 Adapter with Rubber Pad
 BH-7340-26P Rubber Arm Pad Only
 3" x 6" x 3/8" Pad

1-3/8" PIN OD • 3-1/4" LONG PIN
 For Mohawk LMF / TP-15, and others
Nesting Style Height Extension

BH-7340-17 (Ref 018-000-106)
 5" Extension

BH-7340-18 (Ref 012-012-151)
 7-1/2" Extension

BH-7340-19 (Ref 018-000-105)
 10" Extension

Nesting Style Adjustable 1-3/8" (35 mm) Pin Dia.
 Adapter has a 5" x 4" rectangular top formed from heavy 3/8" steel plate with a replaceable rubber pad. Adapters adjust by simply turning the contact pad to the heights listed.

BH-7340-16 Adapter & Pad
 Adjusts 7-1/2" to 9-1/2"

BH-7101-00 Replacement Rubber Pad Only

1-3/8" (35 MM) PIN DIAMETER • 3-1/4" LONG PIN
Specialty Wide Adapter for 2019, 2020 and newer Chevrolet 1500 Silverado and GM Sierra Trucks - 1-3/8" (35 mm) Pin Dia.
 For use with 12,000, 15,000, 16,000 lb. capacity 2-post lifts
 Features 7" Wide Lifting Area • 1-3/8" Pin Dia. x 3-1/4" Long Pin

BH-7340-24GMT (ref 012-012-047) (1) Adapter Base with Pad
 Features BH-7542-75P Rectangle Rubber Pad

TYPE
GMT

7" Wide
Lifting Area

Pin: 1-3/8" Dia. x 3-1/4" Long

Height Extensions and Adapters For Mohawk Lifts

Please always confirm dimensions before ordering. Height Extensions and Adapters come in many different styles and dimensions. SVI is well-known as the adapter expert, specializing in top quality standard and custom adapters. SVI is your answer.



MANY MORE AVAILABLE!
 See common adapters and pads at the beginning of this catalog:
 Height Extensions & Adapters By Type / Style
 Includes Nesting Style Height Extensions, Nesting Pad Adapters,
 Slip-On Style, Drop-On Style, Adjustable and Fixed Adapters, and more!

Additional Height Extensions for Mohawk Lifts FOR VARIOUS MODELS

1-9/16" PIN OD • 1-1/8" LONG PIN
 Nesting Style Height Extension with Roll Pin
 for Mohawk and Autop

BH-7345-01 • 6" Extension
 BH-7345-02 • 10" Extension

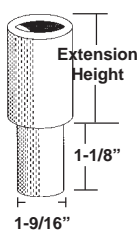



Height Extensions and Adapters For Nussbaum Lifts

Please always confirm dimensions before ordering. Height Extensions and Adapters come in many different styles and dimensions. SVI is well-known as the adapter expert, specializing in top quality standard and custom adapters. SVI is your answer.



MANY MORE AVAILABLE!

See common adapters and pads at the beginning of this catalog:
 Height Extensions & Adapters By Type / Style
 Includes Nesting Style Height Extensions, Nesting Pad Adapters,
 Slip-On Style, Drop-On Style, Adjustable and Fixed Adapters, and more!



Additional Height Extensions for Nussbaum Lifts FOR VARIOUS MODELS

OPENING DIMENSIONS: 5-3/8" X 1-1/2"
 6" Fixed Slip-On Height Extension with Round Pad for Nussbaum TLK

BH-7450-66 • 6" Extension

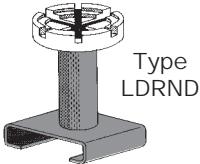

Opening Dimensions:
5-3/8" x 1-1/2"

Replacement Pad: BH-7450-02

OPENING DIMENSIONS: 5-7/16" X 1-3/8"
 Adjustable Slip-On Height Extension with Round Pad for Nussbaum 12000

BH-7450-63 • Adjustable Adapter

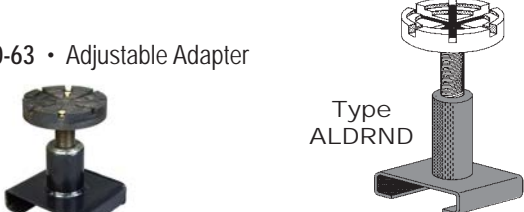

Opening Dimensions:
5-7/16" x 1-3/8"

Replacement Pad: BH-7450-02

1-3/4" PIN OD • 1-3/16" LONG PIN
 Nesting Style Steel Pad Adapter with Round Rubber Pad for Nussbaum (Ref 245SPL28217)

BH-7454-10 Adapter with Pad



Replacement Pad: BH-7450-02

Height Extension with Round Pad for Nussbaum ND 12000

BH-7454-07 (Ref 25.307)



Replacement Pad: BH-7450-02



Height Extensions and Adapters For PMW Lifts

Please always confirm dimensions before ordering. Height Extensions and Adapters come in many different styles and dimensions. SVI is well-known as the adapter expert, specializing in top quality standard and custom adapters. SVI is your answer.



MANY MORE AVAILABLE!

See common adapters and pads at the beginning of this catalog:
 Height Extensions & Adapters By Type / Style
 Includes Nesting Style Height Extensions, Nesting Pad Adapters,
 Slip-On Style, Drop-On Style, Adjustable and Fixed Adapters, and more!



Additional Height Extensions for PMW Lifts

FOR VARIOUS MODELS

1-1/4"-7 THREADS • 5" SQUARE TOP WITH CORNERS TURNED UP
Spin-Up Height Extension

BH-7437-59 (Ref 002655) Without Pad
 BH-7437-60 (Ref 002656) With Octagon Pad



5" Top
 Type SUH5
 Threads
 1-1/4"-7

FOR P.M.W., LINE-O-TRONICS (L.O.T.), KWIK-WAY
Adjustable Slip-On Height Extension with Octagon Pad

BH-7438-06 • 6"-9-1/2" Adjustable

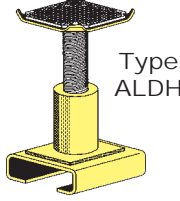

Type
 ALDH

Opening Dimensions:
 5-1/8" x 1"

Replacement Pad: BH-7435-07



Height Extensions and Adapters For Powerrex Lifts

Please always confirm dimensions before ordering. Height Extensions and Adapters come in many different styles and dimensions. SVI is well-known as the adapter expert, specializing in top quality standard and custom adapters. SVI is your answer.



MANY MORE AVAILABLE!

See common adapters and pads at the beginning of this catalog:
 Height Extensions & Adapters By Type / Style
 Includes Nesting Style Height Extensions, Nesting Pad Adapters,
 Slip-On Style, Drop-On Style, Adjustable and Fixed Adapters, and more!



Additional Height Extensions for Powerrex Lifts FOR VARIOUS MODELS

1/2" Thick Rubber Arm Pad
(Ref SL4, SL3)

For Both 1-Hole and 2-Hole Applications

BH-7560-04 1 Pad

Sold Individually



4-11/16" OD
3 Holes

Screw-Up Telescoping Adapter Assembly
for Powerrex, Globe KL-10, SVLD-10,
Complete Lift SL-10, others
(Ref SL5)

BH-7560-05 • 1 Adapter

*This is old style without nut.
See BH-7560-123KIT for new style.*



Use with Rubber Pad: BH-7560-04

Screw-Up Telescoping Adapter with Pad
for Powerrex
(Ref SL5)

BH-7560-123KIT • 1 Adapter

*For Old-Style without Nut,
See BH-7560-05.*



For
Powerrex
2.542" OD
Collar

Use with Rubber Pad: BH-7560-04

Screw-Up Telescoping Truck Adapter with Pad
for Powerrex

BH-7560-124KIT • 1 Adapter



For
Powerrex
2.542" OD
Collar

Use with Rubber Pad: BH-7101-00

OPENING DIMENSIONS: 5-3/16" X 1"

Fixed Slip-On Height Extension with Octagon Pad

BH-7560-01 • 6" Extension (1)
BH-7560-01-4 • 6" Extensions (Set of 4)

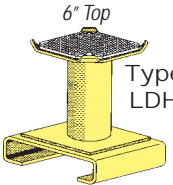
6" Top
Type
LDH

Opening Dimensions: 5-3/16" x 1"
Replacement Pad: BH-7225-01

OPENING DIMENSIONS: 5-3/16" X 1"

4"-6" Adjustable Slip-On Height Extension

BH-7560-02 • 1 Adapter



6" Top
Type
ALDH

Opening
Dimensions:
5-3/16" x 1"
Replacement Pad: BH-7225-01



Height Extensions and Adapters For Quality Lifts

Please always confirm dimensions before ordering. Height Extensions and Adapters come in many different styles and dimensions. SVI is well-known as the adapter expert, specializing in top quality standard and custom adapters. SVI is your answer.



MANY MORE AVAILABLE!
 See common adapters and pads at the beginning of this catalog:
 Height Extensions & Adapters By Type / Style
 Includes Nesting Style Height Extensions, Nesting Pad Adapters,
 Slip-On Style, Drop-On Style, Adjustable and Fixed Adapters, and more!



Additional Height Extensions for Quality Lifts

FOR VARIOUS MODELS

BH-7232-99 (Ref 26K25010)
Arm Support
 Screws right into Arm Insert
Note: Pad Sold Separately



Use with Pad BH-7232-94

Round Rubber Arm Pad with Center Bolt Hole
 (Ref 26K25030)
BH-7232-94 1 Pad Only
 Sold Individually



4-3/4" OD
 1" Thick



BH-7233-163
 (Ref 26K25020, 26M25020)
Arm Support Screw

Adapter Components *Sold Separately*

SVI Part #	OEM #	Description
BH-7233-204	WBM0615	Wrench Bolt
BH-7232-94	26K25030	Arm Support Rubber Footpad
BH-7232-99	26K25010	Arm Support
BH-7233-202	SN-CS25	Snap Ring - Small
BH-7233-163	26K25020	Arm Support 2nd Screw
BH-7233-203	SN-CS45	Snap Ring - Large





Height Extensions and Adapters For Quality Lifts

Please always confirm dimensions before ordering. Height Extensions and Adapters come in many different styles and dimensions. SVI is well-known as the adapter expert, specializing in top quality standard and custom adapters. SVI is your answer.



MANY MORE AVAILABLE!
 See common adapters and pads at the beginning of this catalog:
 Height Extensions & Adapters By Type / Style
 Includes Nesting Style Height Extensions, Nesting Pad Adapters,
 Slip-On Style, Drop-On Style, Adjustable and Fixed Adapters, and more!



Additional Height Extensions for Quality Lifts FOR MODELS Q10



Type NS

Height Extension Kit for Quality Q10, Challenger Lifts, and Others

Pin Diameter 2-3/8" • Pin Length 1-1/2"

BH-7234-119 (Ref 10315) KIT COMES WITH:
 3" Tall Height Extension - Qty (4)
 6" Tall Height Extension - Qty (2)
 Qty (2) Hanging Brackets With Hardware

SVI Part #	OEM #	Pin Diameter	Pin Length	Description
BH-7234-119	10315	2-3/8"	1-1/2"	Height Extension Kit
BH-7234-119A		2-3/8"	1-1/2"	3" Height Extension
BH-7234-119B		2-3/8"	1-1/2"	6" Height Extension
BH-7234-119C				Hanging Bracket
<i>Included with Kit</i>				Pan Head Screws

BH-7232-98 (Ref B2260 / B2250)
 Drop-In Adapter / Foot Pad Assembly with Round Rubber Pad

*Works well with
 BH-7234-119 (ref 10315)
 Height Extension Kit*

Replacement Pad: BH-7232-93



BH-7232-01UPB (Ref B2270)
 Drop-In Adapter / Foot Pad Assembly with Urethane Pad

*Works well with
 BH-7234-119 (ref 10315)
 Height Extension Kit*

Replacement Pad: BH-7232-01U (Ref A1104H, Urethane) or BH-7232-01OHD (Rubber)

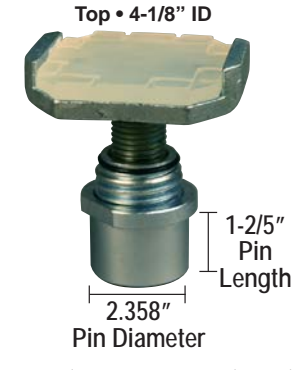

Round Rubber Pad for CL10, VS10, others (Ref B2208)

BH-7232-93 1 Pad
 Sold Individually



Fabric-Reinforced Round Rubber Pad for CL10, others (Ref B2208x, VS10-31-03)

BH-7232-93F 1 Pad
 Sold Individually



Snap-In Urethane Pad (Ref A1104-H)

BH-7232-01U 1 Pad
 Sold Individually



Heavy Duty Bolt-On Rubber Arm Pad
 An SVI Exclusive

BH-7232-01OHD 1 Pad
 BH-7232-01OHD-4 Set of 4 Pads



An Alternative to Snap-In Urethane Pad (Ref A1104-H)

Height Extensions and Adapters For Quality Lifts

Please always confirm dimensions before ordering. Height Extensions and Adapters come in many different styles and dimensions. SVI is well-known as the adapter expert, specializing in top quality standard and custom adapters. SVI is your answer.



MANY MORE AVAILABLE!

See common adapters and pads at the beginning of this catalog:
 Height Extensions & Adapters By Type / Style
 Includes Nesting Style Height Extensions, Nesting Pad Adapters,
 Slip-On Style, Drop-On Style, Adjustable and Fixed Adapters, and more!



Additional Height Extensions for Quality Lifts

FOR MODELS Q1000, 9000AS

5" Slip-On Height Extension with Square Pad
Fits over Double Screw-Up Adapter
 Features Rubber Pad BH-7232-01

SVI Part #	Height	Details	
BH-7234-01	5"	Fixed	1 Adapter
BH-7234-01K	5"	Fixed	Set of 4
BH-7234-01A	5"	Fixed	Base Only (No Pad)



BH-7234-01

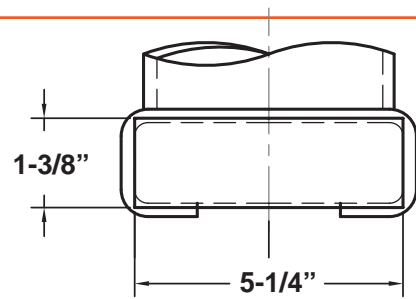

Adapter Base Inside Dimensions
 Shape may vary depending on height extension.

A distributor contacted SVI with a request asking that we produce slip-on height extensions for his customers that own Quality Lift model Q10000. Even though the lift is supplied standard with double screw-up style adapters, sometimes at full spin they still are not high enough. This means a slip-on height extension is necessary in certain situations and for certain vehicles. Of course, SVI responded to the request and is now pleased to let you know about our height extension for Quality Lifts Q10000, 9000AS, others.

When you have an idea, need something special or just simply want a problem you are encountering solved give us a call. We will see what we can come up with. SVI has an innovative can-do spirit and enjoys working on solutions to challenges and opportunities that you discover every day.

Fits over double Screw-Up Adapter



Made in USA
 This part features impeccable hand welding that would beat machines in a welding contest.

May also fit other Korean made lifts
 Confirm dimensions but we think this will also fit Powerrex and Deona lifts that are produced in Korea

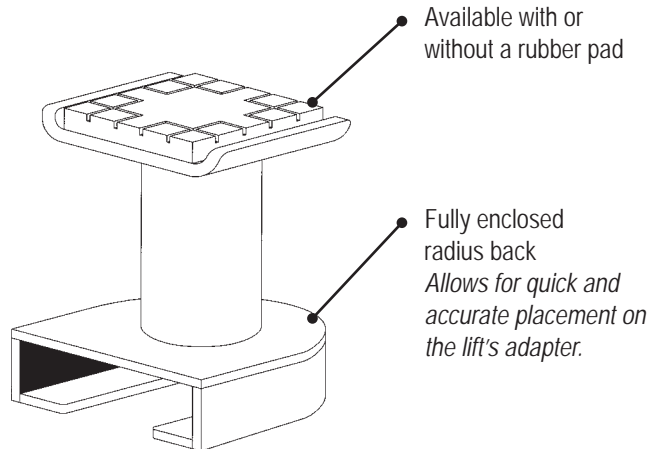



Height Extensions and Adapters For Quality Lifts

Please always confirm dimensions before ordering. Height Extensions and Adapters come in many different styles and dimensions. SVI is well-known as the adapter expert, specializing in top quality standard and custom adapters. SVI is your answer.



MANY MORE AVAILABLE!
 See common adapters and pads at the beginning of this catalog:
 Height Extensions & Adapters By Type / Style
 Includes Nesting Style Height Extensions, Nesting Pad Adapters,
 Slip-On Style, Drop-On Style, Adjustable and Fixed Adapters, and more!

Additional Height Extensions for Quality Lifts

FOR ROLLING BRIDGE JACK QRJ04H, POPULAR ON LIFT MODELS Q4P07, Q4P09

Please confirm dimensions when ordering.

Adjust-A-Spot
 10" Extension Kit for Rolling Jacks
 Includes 2 Extensions with Pins
 BH-7231-46W (Ref RJQRJ04H)



(Note: BH-7474-81 Pictured)

Adjust-A-Spot
 10" Extension Kit for Rolling Jacks
 Includes 2 Extensions with Pins
 BH-7231-46 (Ref RJ45-ADT)

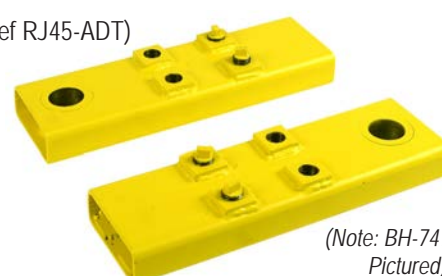

(Note: BH-7474-81 Pictured)



Height Extensions and Adapters For Rotary Lifts

Please always confirm dimensions before ordering. Height Extensions and Adapters come in many different styles and dimensions. SVI is well-known as the adapter expert, specializing in top quality standard and custom adapters. SVI is your answer.



MANY MORE AVAILABLE!
 See common adapters and pads at the beginning of this catalog:
 Height Extensions & Adapters By Type / Style
 Includes Nesting Style Height Extensions, Nesting Pad Adapters,
 Slip-On Style, Drop-On Style, Adjustable and Fixed Adapters, and more!



Additional Height Extensions for Rotary Lifts

For Some 7000, 8000, and 9000 lb. with Round Adapter "RA" and Truck Adapter "TA" Models with Conventional Arms (**Not Trio Models**):

2-Post Surface Mount: A7i, A8, A9i, ATO7, ATO77, S9i, SPO9, SPOA7, SPOA9, SPOA32, others

In-Ground: SL29, others

2" PIN DIAMETER

Adapter Base with Pad
 2" Pin OD • For Rotary
 7,000 and 9,000 lb. models
 with 2-Stage Arms

BH-7504-58
 (Replaces FJ6159ZN, FJ6159)



2"

BH-7542-66 (Ref FJ6202)
 Telescoping 2-Stage Round Thread Up Adapter with Pad
 2" Pin OD • For Models SPOA7-RA, SPOA9-RA, SL210-RA, A8-RA, A10-RA, and SL210-RA



(sold individually) 2" Pin OD

Replaceable Pads: BH-7542-66PK (Kit of 4 Pads with Hardware)

These 2-stage spin-up adapters for use on RA Series Rotary lifts are American-Made and priced as you would expect from SVI. They are built at a quality level equal to or exceeding that of others on the market. Each appropriate piece is individually zinc plated before final assembly. The rubber pad is molded in North America using virgin material, for lifespan longevity; no regrinded material is used in the manufacturing process.

Height Extension with Rack Kit for Rotary - 2" Pin Dia.
 2" Pin Diameter Fits SPOA10RA/TA, SL210 3-Stage 800 Series and Below, and SL212 without Trio Arms

BH-7536-90 (Replaces ref FJ7880 / FJ7880BK)

Kit includes:
 (4) 5" Nesting Extension
 (4) 3-1/2" Nesting Extension
 (2) Hanger Brackets



BH-7515-67 (Ref FJ6171-1B)
 3.5" Nesting Height Extension



3.5" (90mm)
1-3/4"
2"

BH-7515-66 (Ref FJ6171-2B, FJ6171-2ZN)
 5" Nesting Height Extension



5" (130mm)
1-3/4"
2"

BH-7515-68 (Ref FJ6171-2x)
 8" Nesting Height Extension



8" (200mm)
1-3/4"
2"

BH-7536-90A
 Height Extension Rack Kit
 Includes 1 Rack with Hardware



Holds 4 Adapters /
 For 2" Pin Diameter

Specialty Wide Adapter for 2019, 2020 and newer Chevrolet 1500 Silverado and GM Sierra Trucks - 2" Pin OD
 Features 7" Wide Lifting Area • (Ref FJ6258, FJ6258KIT)

BH-7542-75K (2) Adapters with 2" OD Pin & Pad
BH-7542-75 (1) Adapter with 2" OD Pin & Pad
BH-7542-75P Replacement Pad Only
BH-7542-75P-4 Replacement Pad Kit (4)



7" Wide Lifting Area
2" Pin OD



Height Extensions and Adapters For Rotary Lifts

Please always confirm dimensions before ordering. Height Extensions and Adapters come in many different styles and dimensions. SVI is well-known as the adapter expert, specializing in top quality standard and custom adapters. SVI is your answer.



MANY MORE AVAILABLE!

See common adapters and pads at the beginning of this catalog:
 Height Extensions & Adapters By Type / Style
 Includes Nesting Style Height Extensions, Nesting Pad Adapters,
 Slip-On Style, Drop-On Style, Adjustable and Fixed Adapters, and more!



Additional Height Extensions for Rotary Lifts



For Some 10,000 lb. and 12,000 lb. with Round Adapter "RA" and Truck Adapter "TA" Models with Conventional Arms (Not Trio Models):

2-Post Surface Mount: A8i, A10i / A10iNB (400, 500, 600 Series) S10i (400 & 500 Series), SPO10, SPOA10, SPOA10NB, SPO12-700 Series, S12i (7A0, 7T0, 7W0 Series) others

In-Ground: A10-RA, SL210 3-Stage 800 Series & Below, SL210-RA, SL212-1000 Series, others
2" PIN DIAMETER

Truck Adapter Base with Pad for Rotary Lifts
 (Replaces FJ6214, FJ6182, FJ6197)
 2" Pin OD

BH-7536-96 Individual Adapter
 BH-7536-93 Kit of 4 Adapters

Replaceable Pads: BH-7536-92P / BH-7536-92P-4

BH-7542-66 (Ref FJ6202)
Telescoping 2-Stage Round Thread Up Adapter (1) with Pad
 2" Pin OD • For Rotary 10,000 lb. RA models • Sold Individually

These 2-stage spin-up adapters for use on RA Series Rotary lifts are American-Made and priced as you would expect from SVI. They are built at a quality level equal to or exceeding that of others on the market. Each appropriate piece is individually zinc plated before final assembly. The rubber pad is molded in North America using virgin material, for lifespan longevity; no regrinded material is used in the manufacturing process.



2" Pin OD

Replaceable Pads: BH-7542-66P / BH-7542-66PK

Height Extension with Rack Kit for Rotary - 2" Pin Dia.
 2" Pin Diameter Fits SPOA10RA/TA, SL210 3-Stage 800 Series and Below, and SL212 without Trio Arms

BH-7536-90 (Replaces ref FJ7880 / FJ7880BK)

Kit includes:
 (4) 5" Nesting Extension
 (4) 3-1/2" Nesting Extension
 (2) Hanger Brackets



BH-7515-67 (Ref FJ6171-1B)
3.5" Nesting Height Extension



3.5" (90mm)
 1-3/4"
 2"

BH-7515-66 (Ref FJ6171-2B, FJ6171-2ZN)
5" Nesting Height Extension



5" (130mm)
 1-3/4"
 2"

BH-7515-68 (Ref FJ6171-2x)
8" Nesting Height Extension

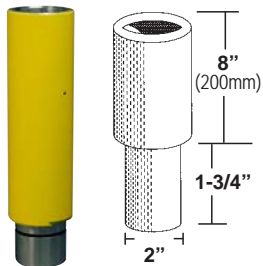

8" (200mm)
 1-3/4"
 2"

BH-7536-90A
Height Extension Rack Kit
 Includes 1 Rack with Hardware



Holds 4 Adapters /
 For 2" Pin Diameter

Specialty Wide Adapter for 2019, 2020 and newer Chevrolet 1500 Silverado and GM Sierra Trucks - 2" Pin OD
 Features 7" Wide Lifting Area • (Ref FJ6258, FJ6258KIT)

BH-7542-75K (2) Adapters with 2" OD Pin & Pad
 BH-7542-75 (1) Adapter with 2" OD Pin & Pad
 BH-7542-75P Replacement Pad Only
 BH-7542-75P-4 Replacement Pad Kit (4)

TYPE
 GMT
 7" Wide
 Lifting Area



2" Pin OD



Height Extensions and Adapters For Rotary Lifts

Please always confirm dimensions before ordering. Height Extensions and Adapters come in many different styles and dimensions. SVI is well-known as the adapter expert, specializing in top quality standard and custom adapters. SVI is your answer.



MANY MORE AVAILABLE!
 See common adapters and pads at the beginning of this catalog:
 Height Extensions & Adapters By Type / Style
 Includes Nesting Style Height Extensions, Nesting Pad Adapters,
 Slip-On Style, Drop-On Style, Adjustable and Fixed Adapters, and more!



Additional Height Extensions for Rotary Lifts

For **MODELS WITH TRIO ARMS:**

2-POST: **SPO10-RA-TRIO, SPO10-TA-TRIO, SPOA10-RA-TRIO, SPOA10-TA-TRIO, others**

IN-GROUND: **SL210-RA-TRIO, SL210-TA-TRIO, SL210-1000 Series (Trio), SLR, others**

1-1/2" PIN DIAMETER



2-Stage Adapter for SLR, SL210 with 1.5" OD Nut
 For RA Models with 3-Stage Trio Arms

BH-9784-82 (ref T100272) Adapter Kit (Set of 4) with Racks
 BH-9784-81 (ref FJ6219) 1 Adapter Only



Spin-Up Style
Adapters

1-1/2" Diameter

Slide Truck Adapters for Lifts with Trio Arm
 For TA Models with 3-Stage Trio Arms

BH-9786-78K (ref T100273) Adapter Kit (Set of 4)
 BH-9786-78 (ref T110564) Individual Adapter (1)



1-1/2" Diameter

Height Extension with Rack Kit for Rotary - 1-1/2" Pin Dia.
 1-1/2" Pin Diameter • Fits SPOA10 Lifts with 3-Stage Arms
 800 Series and Above, SL210-1000, and others with Trio Arms

BH-7536-90T (Replaces ref T100271)

Kit includes:
 (4) 5" Nesting Extension
 (4) 3-1/2" Nesting Extension
 (2) Hanger Brackets



BH-7537-00 (Ref T130660)
 3.5" Nesting Height Extension

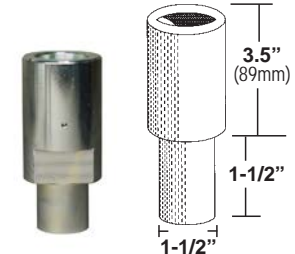

3.5" (89mm)
1-1/2"

BH-7537-01 (Ref T130661)
 5" Nesting Height Extension

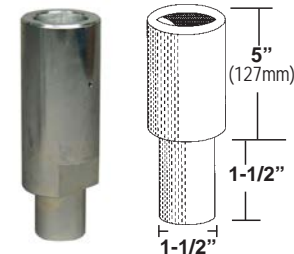

5" (127mm)
1-1/2"

BH-7537-02 (Ref T130683)
 Height Extension Rack Kit
 Includes 1 Rack with Hardware



Holds 4 Adapters /
 For 1-1/2" Pin Diameter

Specialty Wide Adapter for 2019, 2020 and newer Chevrolet
 1500 Silverado and GM Sierra Trucks - 1-1/2" Pin OD
 For TRIO Arms
 Features 7" Wide Lifting Area • (Ref FJ6257, FJ6257KIT)

BH-7542-74K (2) Adapters with 1-1/2" OD Pin & Pad
 BH-7542-74 (1) Adapter with 1-1/2" OD Pin & Pad
 BH-7542-75P Replacement Pad Only
 BH-7542-75P-4 Replacement Pad Kit (4)



1-1/2" Pin OD

TYPE
GMT
 7" Wide
 Lifting Area





Height Extensions and Adapters For Rotary Lifts

Please always confirm dimensions before ordering. Height Extensions and Adapters come in many different styles and dimensions. SVI is well-known as the adapter expert, specializing in top quality standard and custom adapters. SVI is your answer.



MANY MORE AVAILABLE!

See common adapters and pads at the beginning of this catalog:
 Height Extensions & Adapters By Type / Style
 Includes Nesting Style Height Extensions, Nesting Pad Adapters,
 Slip-On Style, Drop-On Style, Adjustable and Fixed Adapters, and more!



Additional Height Extensions for Rotary Lifts

VARIOUS MODELS

1-1/2" PIN DIAMETER

BH-7536-92 (Ref FJ6158)
Lift Adapter Base Assembly with Rubber Pad

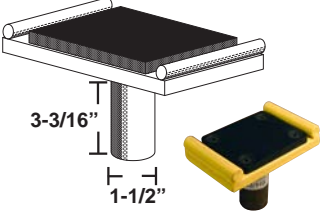

Replacement Rubber Pad: BH-7536-92P
Pad Dimensions: 4-1/8" x 3-1/4"

1-1/2" PIN OD • For Rotary Lifts - Many Models, and Others
Nesting Style Height Extension

1-1/2" OD Pin x 1-1/2" Long Pin
BH-7533-98S (Ref FJ6180) 2-1/2" Extension Height
BH-7533-96 (Ref FJ6143) 4" Extension Height

1-1/2" OD Pin x 1-1/2" Long Pin
BH-7533-97 (Ref FJ6144) 8" Extension Height

BH-7500-95 (Ref FJ6145) Hanger Bracket Rack for 1-1/2" OD Pins (without hardware)

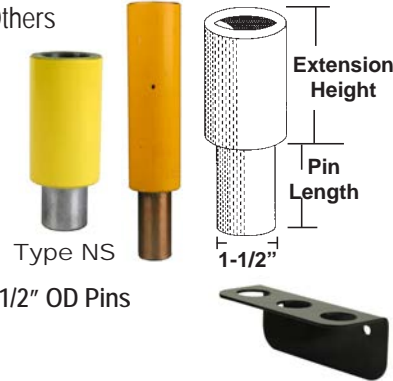

Extension Height
Pin Length
1-1/2"

Type NS

1.575" (40mm) PIN DIAMETER • FOR PV12, OTHERS

BH-7548-003 (Ref V12TP-4303)
2" Nesting Style Height Extension

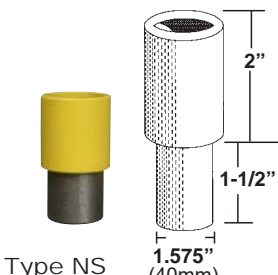

Type NS

BH-7548-001 (Ref V12TP-4301)
Short Nesting Style Height Extension

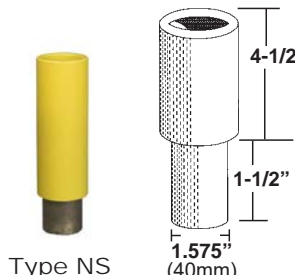

Type NS

BH-7548-002 (Ref V12TP-4302)
8-1/2" Tall Nesting Style Height Extension

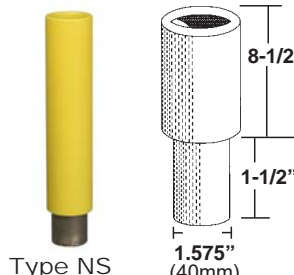

Type NS

BH-7548-004 (Ref V12TP-4410)
Lift Pad Weldment 40mm (1.575") Pin Diameter
Pad Sold Separately



Type NSP
1.575" Dia. (40mm)

Use with Pad BH-7270-048 or BH-7820-04

1-3/4" PIN DIAMETER

Nesting Height Extension 1-3/4" OD Pin x 1-1/2" Long Pin

BH-7533-98 (Ref FJ6146) 3-1/2" Extension

BH-7533-99 (Ref FJ6147) 5" Extension

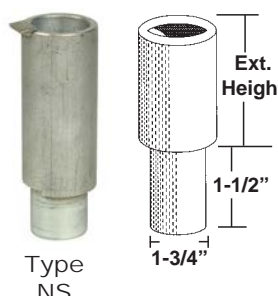

Ext. Height
1-1/2"
1-3/4"

Type NS



Height Extensions and Adapters For Rotary Lifts

Please always confirm dimensions before ordering. Height Extensions and Adapters come in many different styles and dimensions. SVI is well-known as the adapter expert, specializing in top quality standard and custom adapters. SVI is your answer.







MANY MORE AVAILABLE!
 See common adapters and pads at the beginning of this catalog:
 Height Extensions & Adapters By Type / Style
 Includes Nesting Style Height Extensions, Nesting Pad Adapters,
 Slip-On Style, Drop-On Style, Adjustable and Fixed Adapters, and more!



Additional Height Extensions for Rotary Lifts

VARIOUS MODELS

2-3/4" PIN DIAMETER

<p>2-3/4" NUT/COLLAR OD BH-7536-50 (Ref FJ7822-1) Swing Arm Adapter Assembly for SPO15, SPO18, S15i, S18i, others</p>  <p style="text-align: right; margin-right: 20px;">For Rotary</p> <p style="text-align: center;">┌-2-3/4"-┐</p> <p><small>Use with BH-7536-51 Rubber Adapter Pad (Ref FJ7822-2, FJ7822-2YL)</small></p>	<p>BH-7536-51 (Ref FJ7822-2, FJ7822-2YL) Rubber Adapter Pad for SPO15, SPO18, S15i, S18i, others</p> 	<p>2-3/4" NUT/COLLAR OD Screw Adapter and Base with 2-3/4" Collar / Nut OD for SPO16 / SPO20</p> <p>BH-7548-025 (Ref FJ71011)</p>  <p style="text-align: right; margin-right: 20px;">For Rotary</p> <p style="text-align: center;">┌-2-3/4"-┐</p>
---	--	---

<p>Nesting Style Height Extensions - Aluminum</p> <ul style="list-style-type: none"> BH-7536-53A 4" Extension BH-7536-53 5" Extension (Ref FJ7822-4) BH-7536-53B 6" Extension BH-7536-55 7-1/2" Extension (Ref FJ7822-6) BH-7536-54 10" Extension (Ref FJ7822-5)  	<p>BH-7536-52 (Ref FJ822-3) Height Extension Holder Rack for 2-3/4" Pin</p> 
--	---

Specialty Wide Adapter for 2019, 2020 and newer Chevrolet 1500 Silverado and GM Sierra Trucks - 2-3/4" Collar / Nut OD
 Features 7" Wide Lifting Area • (Ref FJ7822-1x)

BH-7536-50GMT (2) Adapters with 2-3/4" Collar & Pad
BH-7536-50GMT-1 (1) Adapter with 2-3/4" Collar & Pad
BH-7542-75P Replacement Pad Only
BH-7542-75P-4 Replacement Pad Kit (4)

TYPE
GMT
 7" Wide Lifting Area

For SPO15, SPO18, others



2-3/4" OD Collar

Specialty Wide Adapter for 2019, 2020 and newer Chevrolet 1500 Silverado and GM Sierra Trucks - 2-3/4" Collar / Nut OD
 Features 7" Wide Lifting Area • (Ref FJ71011xx)

BH-7548-025GMT-2 (2) Adapters with 2-3/4" Collar & Pad
BH-7548-025GMT-1 (1) Adapter with 2-3/4" Collar & Pad

Features BH-7542-75P Rectangle Rubber Pad

TYPE
GMT
 7" Wide Lifting Area

For SPO16, SPO20, others



2-3/4" Collar OD



Height Extensions and Adapters For Rotary Lifts

Please always confirm dimensions before ordering. Height Extensions and Adapters come in many different styles and dimensions. SVI is well-known as the adapter expert, specializing in top quality standard and custom adapters. SVI is your answer.



MANY MORE AVAILABLE!

See common adapters and pads at the beginning of this catalog:
 Height Extensions & Adapters By Type / Style
 Includes Nesting Style Height Extensions, Nesting Pad Adapters,
 Slip-On Style, Drop-On Style, Adjustable and Fixed Adapters, and more!



Additional Height Extensions for Rotary Lifts

VARIOUS MODELS

BH-7500-80-1
Luxury Inner Arm Adapter 4"
for Rotary Lifts



Replaceable Pad: BH-7101-00

BH-7500-81-1
Luxury Inner Arm Adapter 3"
for Any Lift Make with 3" Arm



Replaceable Pad: BH-7101-00

FOR ROLLING BRIDGE JACKS

BH-7514-35 (Ref FC579) Height Extension - 5"
BH-7514-35A (Ref FC579x) Height Extension - 8"

BH-7514-54 (Ref FC5108) Height Extension - 3"
BH-7514-54A (Ref FC5108x) Height Extension - 8"



BH-7514-77 (Ref SB100003)
Rolling Jack Adapters
(Set of 2) for Land Rover
and other SUV / Straight
Axle Vehicles

BH-7525-11 (Ref FC5113)
Left Sliding Base & Adapter
for FC5124, others



LEFT

BH-7514-53 (Ref FC577)
Right Sliding Base & Adapter
for FC5124, others



RIGHT

BH-7514-55 (Ref FC5185-7)
Left Sliding Base & Adapter
for FC5269, FC5277, FC5278,
FC5279, others

LEFT



LEFT

BH-7525-73 (Ref FC5185-10)
Right Sliding Base & Adapter
for FC5269, FC5277, FC5278,
FC5279, others



RIGHT

Height Extensions and Adapters For Rotary Lifts

Please always confirm dimensions before ordering. Height Extensions and Adapters come in many different styles and dimensions. SVI is well-known as the adapter expert, specializing in top quality standard and custom adapters. SVI is your answer.

MANY MORE AVAILABLE!
*See common adapters and pads at the beginning of this catalog:
 Height Extensions & Adapters By Type / Style
 Includes Nesting Style Height Extensions, Nesting Pad Adapters,
 Slip-On Style, Drop-On Style, Adjustable and Fixed Adapters, and more!*

Additional Height Extensions for Rotary Lifts

FOR ROLLING BRIDGE JACKS

<p>BH-7530-69 (Ref FC5701) Left Sliding Base & Adapter for FC5655, FC5656, FC5657, FC5660, FC5661, FC5662, FC5751, others</p> <div style="text-align: center;"> <p>LEFT</p> </div>	<p>BH-7530-68 (Ref FC5700) Right Sliding Base & Adapter for FC5655, FC5656, FC5657, FC5660, FC5661, FC5662, FC5751, others</p> <div style="text-align: center;"> <p>RIGHT</p> </div>	<p>BH-7530-56 (Ref FC5682-5) Left Sliding Base & Adapter for FC5682-50, FC5710, others</p> <div style="text-align: center;"> <p>LEFT</p> </div>	<p>BH-7530-59 (Ref FC5682-6) Right Sliding Base & Adapter for FC5682-50, FC5710, others</p> <div style="text-align: center;"> <p>RIGHT</p> </div>
<p>BH-7531-85 (Ref FC5818-24) Left Sliding Base & Adapter for FC5818, RJ9000, RJ9001, RJ4100, others</p> <div style="text-align: center;"> <p>LEFT</p> </div>	<p>BH-7531-87 (Ref FC5818-37) Right Sliding Base & Adapter for FC5818, RJ9000, RJ9001, RJ4100, others</p> <div style="text-align: center;"> <p>RIGHT</p> </div>		

Flip-Up Axle Engagement Adapters for Dual Saddle and others types

FOR 10210 & 1012 Models, and others...

<p>BH-9790-92 (Ref FD2215) Flip-Up Adapter DSE 8"</p> <div style="text-align: center;"> </div>	<p>BH-9790-92A Flip-Up Adapter DSE 10"</p> <div style="text-align: center;"> </div>
---	---



Height Extensions and Adapters For Rotary Lifts

Please always confirm dimensions before ordering. Height Extensions and Adapters come in many different styles and dimensions. SVI is well-known as the adapter expert, specializing in top quality standard and custom adapters. SVI is your answer.



MANY MORE AVAILABLE!

See common adapters and pads at the beginning of this catalog:
 Height Extensions & Adapters By Type / Style
*Includes Nesting Style Height Extensions, Nesting Pad Adapters,
 Slip-On Style, Drop-On Style, Adjustable and Fixed Adapters, and more!*



For Rotary Lifts - For Both 2-Post Surface Mount and In-Ground Lifts For LIFTS WITH FLIP-UP STYLE ADAPTERS - MANY MODELS









*Includes both Short and Long Swivel Pins—
Varies Per Application.*

Flip-Up Adapter Repair Kits for Rotary Lifts

SVI Part #	Ref #	Description / Details
BH-9755-36	FJ671-7	Adapter Repair Kit for 4 Arms
BH-9755-36-1	FJ671-8	Adapter Repair Kit for 1 Arm
BH-9755-20	FJ671-1	High Step Ductile Iron Adapter
BH-9755-21	FJ671-2	Low Step Ductile Iron Adapter
BH-9755-22	FJ671-3	Adapter Pivot Pin
BH-9755-25	FJ671-5	Adapter Swivel Pin (Short) for In-Ground Applications
BH-9755-25L	FJ79-6	Adapter Swivel Pin (Long) for Surface Mount Applications
BH-9755-26	FJ671-6	3/32" Hog Ring

Sleeve and Adapter Assemblies are Available in Various Sizes / Lengths. Contact SVI today!

<p>BH-9755-20 (Ref FJ671-1, FJ6177) High Step Ductile Iron Adapter</p> 	<p>BH-9755-21 (Ref FJ671-2, FJ6178) Low Step Ductile Iron Adapter</p> 	<p>BH-9755-25 (Ref FJ671-5) Adapter Swivel Pin (Short)</p> <p>BH-9755-25L (Ref FJ79-6) Adapter Swivel Pin (Long)</p>  <p><i>Overall Height: Short: 1.375 Long: 1.625</i></p>	<p>BH-9755-26 (Ref FJ671-6) 3/32" Hog Ring</p> 
<p>BH-9755-22 (Ref FJ671-3) Adapter Pivot Pin <i>Holes at both ends</i></p> 	<p>BH-7533-60 (Ref FJ6179) Adapter Pivot Pin <i>Hole at one end</i></p> 		

Height Extensions and Adapters For Rotary Lifts

Please always confirm dimensions before ordering. Height Extensions and Adapters come in many different styles and dimensions. SVI is well-known as the adapter expert, specializing in top quality standard and custom adapters. SVI is your answer.

SLEEVE AND ADAPTER ASSEMBLIES

Please Confirm Dimensions

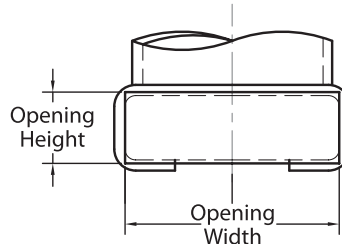
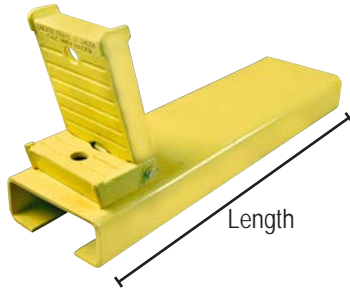

<p>BH-9755-36 (Ref FJ671-7) Adapter Repair Kit for 4 Arms BH-9755-36-1 (Ref FJ671-8) Adapter Repair Kit for 1 Arm</p> 	<p>Sleeve and Adapter Assembly <i>Sold Individually</i></p> <p>BH-9760-25 (Ref FJ692) 19" Long For Front BH-9760-23 (Ref FJ693) 24" Long For Rear BH-9755-31 (Ref FJ6102) 21" Long For Front BH-9755-32 (Ref FJ6103) 26" Long For Rear</p>  <p><i>Opening Dimensions: 5-1/4" x 1-27/32"</i></p>	<p>BH-9755-33 (Ref FJ678, FJ625) Sleeve and Adapter Assembly 14-1/2" Long <i>Sold Individually</i></p>  <p><i>Opening Dimensions: 6-1/8" x 1-7/8"</i></p>
<p>Sleeve and Adapter Assembly <i>Sold Individually</i></p> <p>BH-9755-19 (Ref FJ671) 19" Long For Front BH-9755-27 (Ref FJ672, FJ661) 24" Long For Rear BH-9755-28 (Ref FJ679, FJ654) 16" Long</p>  <p><i>Opening Dimensions: 6-1/4" x 1-19/32"</i></p>	<p>BH-9755-29 (Ref FJ680, FJ628, FJ638) Sleeve and Adapter Assembly 14-11/16" Long <i>Sold Individually</i></p>  <p><i>Opening Dimensions: 6-3/8" x 1-1/8"</i></p>	<p>BH-9755-30 (Ref FJ681) Sleeve and Adapter Assembly 13-5/8" Long <i>Sold Individually</i></p>  <p><i>Opening Dimensions: 8-3/8" x 1-5/8"</i></p>

SVI Part #	Ref. OEM #	Length	Opening Width	Opening Height	For Lift Models / Applications:
BH-9755-31	FJ6102	21"	5-1/4"	1-27/32"	Current Style: Front Side-by-Side WRP90
BH-9755-32	FJ6103	26"	5-1/4"	1-27/32"	Current Style: Rear Side-by-Side DTO28H
BH-9760-23	FJ693	24"	5-1/4"	1-27/32"	Current Style for Rear Side by Side DTO28H
BH-9760-25	FJ692	19"	5-1/4"	1-27/32"	Current Style for Front Side by Side DTO28H and Single Post FP46A & H
BH-9755-33	FJ678	14-1/2"	6-1/8"	1-7/8"	Rounded Corner Obsolete Style
BH-9755-19	FJ671	19"	6-1/4"	1-19/32"	Old Style for Front Side-by-Side and DTO28H and Single Post FP46A & H
BH-9755-27	FJ672	24"	6-1/4"	1-19/32"	Old Style for Rear Side-by-Side DTO28H
BH-9755-28	FJ679	16"	6-1/4"	1-19/32"	Obsolete Style
BH-9755-29	FJ680	14-11/16"	6-3/8"	1-1/8"	Obsolete Style
BH-9755-30	FJ681	13-5/8"	8-3/8"	1-5/8"	Obsolete Style



Height Extensions and Adapters For Rotary Lifts

Please always confirm dimensions before ordering. Height Extensions and Adapters come in many different styles and dimensions. SVI is well-known as the adapter expert, specializing in top quality standard and custom adapters. SVI is your answer.





MANY MORE AVAILABLE!

See common adapters and pads at the beginning of this catalog:
 Height Extensions & Adapters By Type / Style
 Includes Nesting Style Height Extensions, Nesting Pad Adapters,
 Slip-On Style, Drop-On Style, Adjustable and Fixed Adapters, and more!



For Rotary Lifts - For Both 2-Post Surface Mount and In-Ground Lifts

For LIFTS WITH FLIP-UP STYLE ADAPTERS - MANY MODELS

SPR1 Slip-Over Protective Pad
 Drop-On Protective Rectangle Rubber Pad Adapter for Flip-Up
 Protects Vehicle Undercoating
 BH-9789-98 (Ref FJ697)



Fits over Flip Up Adapters

Opening Dimensions:
4-11/16" x 1"

Type SPR1

Replaceable Pad: BH-7101-00



BH-9789-98

Pictured on Flip-Ups and Arm. Sold Separately.

BH-7502-01 (Ref FJ697)
 Rubber Pad Adapter (Low)

BH-7511-68 (Ref FJ6138BK)
 Kit of 4 Adapters with
 Hanger Brackets & Fasteners



SVI Recommends # BH-9789-98

BH-7502-06 (Ref FJ698)
 Rubber Pad Adapter (High)



Opening Dimensions:
4-5/8" x 1-5/8"

Also See BH-7533-65 Adapter Kit

SPR Slip-Over Protective Pad - FIXED
 Drop-On FIXED Height with Rectangle Rubber Arm Pad

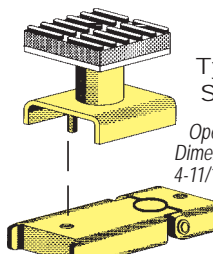

Fits over Flip Up Adapters

Opening Dimensions:
4-11/16" x 1"

Type SPR

BH-9789-93 • 3" Extension
 BH-9789-94 • 4" Extension
 BH-9789-95 • 5" Extension
 BH-9789-96 • 6" Extension

Replaceable Pad: BH-7101-00

ASPR Slip-Over Protective Pad-ADJUSTABLE
 4" to 6" Adjustable Drop-On Height Extension
 with Rectangle Rubber Arm Pad
 BH-9789-97



Opening Dimensions:
4-11/16" x 1"

Fits over Flip Up Adapters

Replaceable Pad: BH-7101-00

Type ASPR



Height Extensions and Adapters For Rotary Lifts

Please always confirm dimensions before ordering. Height Extensions and Adapters come in many different styles and dimensions. SVI is well-known as the adapter expert, specializing in top quality standard and custom adapters. SVI is your answer.

For Rotary Lifts - For Both 2-Post Surface Mount and In-Ground Lifts

For LIFTS WITH FLIP-UP STYLE ADAPTERS - MANY MODELS

SOR Drop-On Extension Without Pad

BH-9755-50 (Ref FJ696YL, FJ696)
9" Drop-On Height Extension without Pad

For Kit with Brackets, See BH-9755-50S or BH-7533-65

Fits over Flip Up Adapters

4-3/4" ID
Type SOR
Opening Dimensions: 4-5/8" x 1-5/8"

NOTE: Also available as wide style GMT Adapters for use with 2019, 2020, and newer Chevrolet 1500 Silverado and GMC Sierra Trucks.

SOR Drop-On Extension Without Pad

BH-9755-50A (Ref FJ6196)
12" Drop-On Height Extension without Pad

For Kit with Brackets, See BH-9755-50SL

Fits over Flip Up Adapters

4-3/4" ID
Type SOR
Opening Dimensions: 4-5/8" x 1-5/8"

NOTE: Also available as wide style GMT Adapters for use with 2019, 2020, and newer Chevrolet 1500 Silverado and GMC Sierra Trucks.

SORP Drop-On Extension With Pad

BH-9755-50B (Ref FJ6101)
9" Drop-On Height Extension with Pad

Replaceable Pad: BH-9755-50-1
Don't forget Hanger Brackets: BH-9755-50H

Fits over Flip Up Adapters

4-3/4" ID
Type SORP
Opening Dimensions: 4-5/8" x 1-5/8"

NOTE: Also available as wide style GMT Adapters for use with 2019, 2020, and newer Chevrolet 1500 Silverado and GMC Sierra Trucks.

SORP Drop-On Extension With Pad

BH-9755-50C
12" Drop-On Height Extension with Pad

Replaceable Pad: BH-9755-50-1
Don't forget Hanger Brackets: BH-9755-50H

Fits over Flip Up Adapters

4-3/4" ID
Type SORP
Opening Dimensions: 4-5/8" x 1-5/8"

NOTE: Also available as wide style GMT Adapters for use with 2019, 2020, and newer Chevrolet 1500 Silverado and GMC Sierra Trucks.

SORNA Screw-Up Drop-On - ADJ.

Slip-On Adjustable Spin-Up Height Extension with Heavy Duty Octagon Pad

BH-9755-49

Fits over Flip Up Adapters

Adjustable 7"-11"
Type SORNA
Opening Dimensions: 4-7/8" x 1"

With Octagon Pad
Replaceable Pad: BH-7235-90AX

SONRW Narrow Drop-On Extension

For Close to Frame Obstructions

BH-9755-48 • 9" Drop-On Height Extension with Pad

Fits over Flip Up Adapters

Fuel Tank
Frame
Brake Lines
Type SONRW
Replaceable Pad: BH-9900-10

Avoids denting or puncturing fuel tank and smashing brake lines. Commonly sold for use on the rear of late model trucks and SUVs.

Specialty ADJUSTABLE

Adjustable Adapter and Mounting Rack Kit (Set of 4 Adapters with Pads)

For Mini-Vans with Running Boards

BH-7500-90 (Ref FJ6137)

Fits over Flip Up Adapters

Replaceable Pad: BH-7508-61

BH-9755-50H (Ref FJ6114)
Hanger Brackets - Set of 2

This pair of brackets holds (4) BH-9755-50 Series Extensions



Height Extensions and Adapters For Rotary Lifts

Please always confirm dimensions before ordering. Height Extensions and Adapters come in many different styles and dimensions. SVI is well-known as the adapter expert, specializing in top quality standard and custom adapters. SVI is your answer.

For Rotary Lifts - For Both 2-Post Surface Mount and In-Ground Lifts

For LIFTS WITH FLIP-UP STYLE ADAPTERS - MANY MODELS

BH-9755-50S (Ref FJ6115)
9" Drop-On Height Extension Adapters and Rack Set
 Kit Includes (4) BH-9755-50 (Ref FJ696YL) Adapters
 and BH-9755-50H (Ref FJ6114) Hanger Brackets - Pair
 4-3/4" ID



Fits over Flip Up Adapters
 Type SOR

Also See Adapter Kit BH-7533-65 (Ref FJ6100)

BH-9755-50SL (Ref FJ6195)
12" Drop-On Height Extension Adapters and Rack Set
 Kit Includes (4) BH-9755-50A (Ref FJ696YL) Adapters
 and BH-9755-50H (Ref FJ6114) Hanger Brackets - Pair



Fits over Flip Up Adapters
 Type SOR

BH-7533-65 (Ref FJ6100)
Adapter Kit with Hanger Bracket Rack Kit

Kit Includes:
 (4) BH-9755-50 (Ref FJ696) 9" Drop-On Height Extension **(No Pad)**
 (4) BH-9789-98 (Ref FJ697) Protective Rubber Pad Adapter
 (4) BH-7502-06 (Ref FJ698) Rubber Pad Adapter (High)
 (1) BH-7533-70 (Ref FJ6108) Mixed Rack Kit Brackets Set

Type SOR
Fits over Flip Up Adapters



Hanger Brackets Included

BH-7533-68 (Ref FJ6104)
Adapter Kit with Hanger Bracket Rack Kit

Kit Includes:
 (4) BH-9755-50B (Ref FJ6101) 9" Drop-On Height Extension **w/ Pad**
 (4) BH-9789-98 (Ref FJ697) Protective Rubber Pad Adapter
 (4) BH-7502-06 (Ref FJ698) Rubber Pad Adapter (High)
 (1) BH-7533-70 (Ref FJ6108) Mixed Rack Kit Brackets Set

Type SORP
Fits over Flip Up Adapters

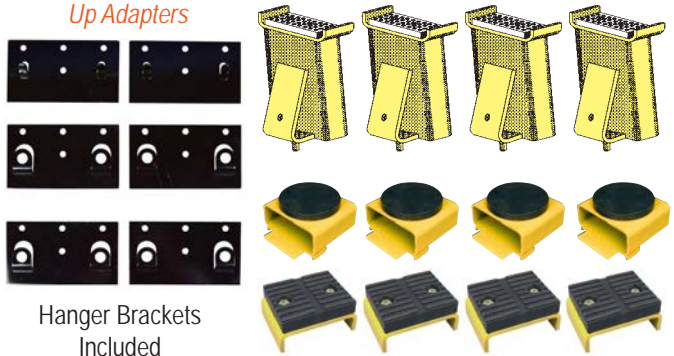

Hanger Brackets Included

BH-7533-69 (Ref FJ6105)
Adapter Kit with Hanger Bracket Rack Kit

Kit Includes:
 (2) BH-9755-50 (Ref FJ696) 9" Drop-On Height Extension **No Pad**
 (2) BH-9755-50B (Ref FJ6101) 9" Drop-On Height Extension **with Pad**
 (4) BH-9789-98 (Ref FJ697) Protective Rubber Pad Adapter
 (4) BH-7502-06 (Ref FJ698) Rubber Pad Adapter (High)
 (1) BH-7533-70 (Ref FJ6108) Mixed Rack Kit Brackets Set

Fits over Flip Up Adapters
 Type SOR / SORP

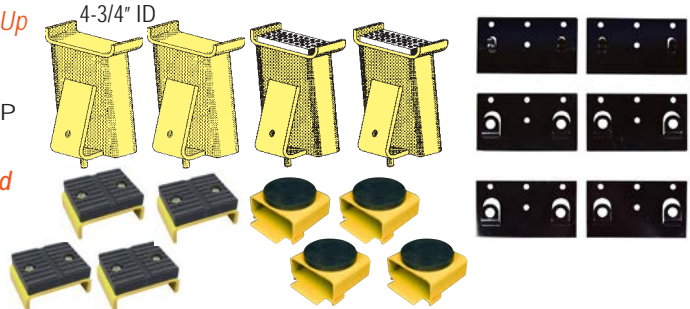



Height Extensions and Adapters For Rotary Lifts

Please always confirm dimensions before ordering. Height Extensions and Adapters come in many different styles and dimensions. SVI is well-known as the adapter expert, specializing in top quality standard and custom adapters. SVI is your answer.



MANY MORE AVAILABLE!

See common adapters and pads at the beginning of this catalog:
 Height Extensions & Adapters By Type / Style
 Includes Nesting Style Height Extensions, Nesting Pad Adapters,
 Slip-On Style, Drop-On Style, Adjustable and Fixed Adapters, and more!



For Rotary Lifts - For Both 2-Post Surface Mount and In-Ground Lifts For LIFTS WITH FLIP-UP STYLE ADAPTERS - MANY MODELS



Specialty Lift Adapters



FOR 2019, 2020 AND NEWER

Chevrolet 1500 Silverado and GMC Sierra Truck Models



Adapter Kit
 for Use over
 Flip-Ups
 BH-9755-50GMT
 (ref FJ6259)

Front
 BH-9755-50GMT-1
 BH-9755-50GMT-2

Rear
 BH-9755-50GMT-3
 BH-9755-50GMT-4

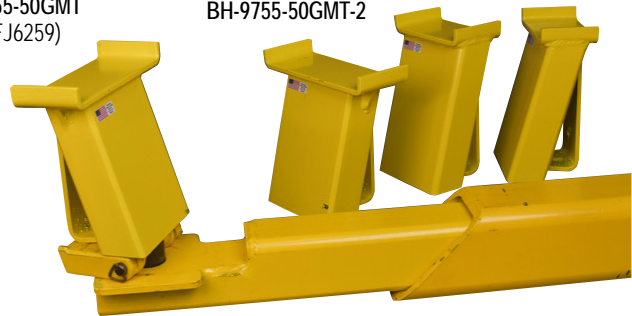

Front Adapters have 7" Wide Lifting Area



Inside Dimensions:
 4-5/8" x 1.61"

FOR ANY ROTARY MODEL WITH FLIP-UP ADAPTERS

BH-9755-50GMT	FJ6259	Flip-Up Adapter Height Ext KIT (Set of 4)
	FJ6259KIT	Includes (2) Front / (2) Rear
BH-9755-50GMT-1	FJ6259x	Flip-Up Height Ext - Front
BH-9755-50GMT-2	FJ6259xx	Flip-Up Height Ext - Front (Set of 2)
BH-9755-50GMT-3	FJ6259xxx	Flip-Up Height Ext - Rear
BH-9755-50GMT-4	FJ6259xxx	Flip-Up Height Ext - Rear (Set of 2)
BH-9755-50H-GMT	FJ6114x	Hanger Brackets for BH-9755-50GMT

On-going SVI engineering and production activities are occurring to provide lifting adapters for many makes and models of lifts so the new 2019, 2020 and after GM Trucks can be correctly accommodated on virtually any lift. SVI employs a professional staff of engineers who are well-suited to design products to satisfy the requirements and internal self testing is also routinely performed, where applicable.

SOLD SEPARATELY:

BH-9755-50H-GMT (Ref FJ6114-x)
Specialty Wide-Style Hanger Brackets
(Set of 2) for BH-9755-50GMT

Each pair of brackets holds
 (4) BH-9755-50GMT Series Adapters

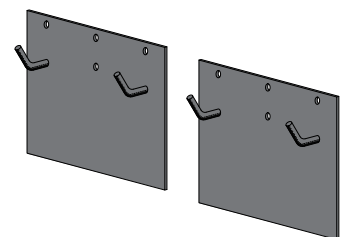

Have another type of lift? Call 800-321-8173 for GMT style adapters for any lift make.

More Styles Available—See common "Height Extensions & Adapters By Type / Style" at the beginning of this catalog!

Page



Height Extensions and Adapters For Rotary Lifts

Please always confirm dimensions before ordering. Height Extensions and Adapters come in many different styles and dimensions. SVI is well-known as the adapter expert, specializing in top quality standard and custom adapters. SVI is your answer.



MANY MORE AVAILABLE!
See common adapters and pads at the beginning of this catalog:
 Height Extensions & Adapters By Type / Style
*Includes Nesting Style Height Extensions, Nesting Pad Adapters,
 Slip-On Style, Drop-On Style, Adjustable and Fixed Adapters, and more!*



Additional Height Extensions for Rotary Lifts

FOR VARIOUS PAD LIFTS AND LOW RISE / MID RISE MODELS

RUBBER PADS

FOR SPO82, SPOA82, WOA83, SL9-FP, SL90204
 BH-9756-25 (Ref FJ2252-5, FJ2195-4-KIT) **Standard Replacement Pad (1)**
 BH-9756-26 (Ref FJ2252-6 / FJ2195-5-KIT) **Heat Resistant Pad**

Other Pads Available!
Call SVI Today!

FOR SPOA82 (100-199 Series, 200-299 Series, 300 Series)
 BH-7528-26 (Ref N22-7) **Rubber Pad (Left Front)**
 BH-7528-13 (Ref N21-12) **Rubber Pad (Right Front)**
 Call SVI (Ref N217-5) **Rubber Pad (Left Rear)**
 Call SVI (Ref N216-9) **Rubber Pad (Right Rear)**



Pictured
 BH-7546-002
 (Ref FJ2433)

FOR SPOA82 (500 Series), A7Pi
 BH-7546-002 (Ref FJ2433) **Rubber Pad with Reinforcement**
Dimensions: 18-7/8" x 19-5/8" x 1/2" Thick
Bolts Sold Separately: BH-7546-002B (Ref 40077)

FOR MPFXA, MPFXE
 BH-9756-26 (Ref FJ2252-6) **Heat Resistant Pad**

FOR PFX-1
 BH-7505-10 (Ref FJ2195-3) **Rubber Pad (right front)**
 BH-7505-13 (Ref FJ2196-20) **Rubber Pad**



FOR PFXA, PFXE, SL29-FP, SL28
 BH-9756-25 (Ref FJ2252-5, FJ2195-4-KIT) **Standard Replacement Pad (1)**
 BH-9756-26 (Ref FJ2252-6 / FJ2195-5-KIT) **Heat Resistant Pad**

FOR VLX6 SERIES AND VLXS6
 BH-7546-002 (Ref FJ2433) **Rubber Pad with Reinforcement for VLX6 Series**

FOR PF10A-100 / PF10H-100 AND ABOVE,
 PT20H-11, PT20H MKIII, SL29-SPA, SL9-SPA,
 OTHERS

Dimensions 18" x 8" x 1/2"

BH-7505-12 (Ref FJ2177-2) **Rubber Pad (1)**
 BH-7505-12K (Ref GP1012) **Rubber Pad Kit (Set of 4)**

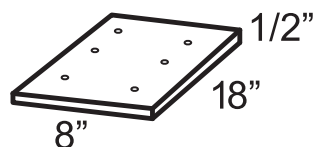



Height Extensions and Adapters For Stenhoj

Please always confirm dimensions before ordering. Height Extensions and Adapters come in many different styles and dimensions. SVI is well-known as the adapter expert, specializing in top quality standard and custom adapters. SVI is your answer.



MANY MORE AVAILABLE!
 See common adapters and pads at the beginning of this catalog:
 Height Extensions & Adapters By Type / Style
 Includes Nesting Style Height Extensions, Nesting Pad Adapters,
 Slip-On Style, Drop-On Style, Adjustable and Fixed Adapters, and more!

Additional Height Extensions for Stenhoj Lifts

FOR VARIOUS MODELS

1.57" (40 MM) NUT/COLLAR OD
Spin-Up Adapter (1) for Stenhoj • BH-7588-29
 1.57" (40mm) Pin Diameter • Pin Length 1-1/8"



For Stenhoj

Replaceable Rubber Arm Pad: BH-7450-02



Height Extensions and Adapters For Tuxedo Lifts

Please always confirm dimensions before ordering. Height Extensions and Adapters come in many different styles and dimensions. SVI is well-known as the adapter expert, specializing in top quality standard and custom adapters. SVI is your answer.



MANY MORE AVAILABLE!

See common adapters and pads at the beginning of this catalog:
 Height Extensions & Adapters By Type / Style
 Includes Nesting Style Height Extensions, Nesting Pad Adapters,
 Slip-On Style, Drop-On Style, Adjustable and Fixed Adapters, and more!



Additional Height Extensions for Tuxedo Lifts FOR VARIOUS MODELS

<p>Rectangle Rubber Arm Pad (Ref 82365, others) BH-7101-00 1 Pad Only BH-7101-00-4 Kit of 4 Pads and Hardware</p>  <p style="text-align: center;">3-7/8" x 4-7/8" x 7/8"</p>	<p>5" Octagon Rubber Arm Pad BH-7270-048 Individual Pad</p>  <p style="text-align: center;">1/2" Thick Pad Holes are 3.6" Apart</p>	<p>Steel Adapter Base for Kernel 9,000 Lb. Lift Models such as 9000BF, 9000BSA, GTX-09-OH-T, GTX-09-FP, MTP-9A, MTP-9F, and Tuxedo BH-7486-01</p> <p style="text-align: center;">Replaceable Pad: BH-7270-048</p>	<p>Adapter Base and Rubber Pad Assembly for Tuxedo Lifts and Kernel 11,000 Lb Lift Models GTX-10-OH, 11000BSA, MTP-11A BH-7487-02</p>  <p style="text-align: center;">Replaceable Pad: BH-7270-048</p>
--	---	---	---

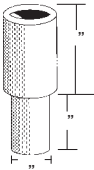
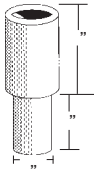
<p>Nesting Height Extensions for for Kernel 9,000 Lb. Lift Models such as 9000BF, 9000BSA, GTX-09-OH-T, GTX-09-FP, MTP-9A, MTP-9F, and Tuxedo BH-7486-44 - Short BH-7486-45 - Long</p> 	<p>Nesting Height Extensions for for Tuxedo Lifts and Kernel 11,000 Lb Lift Models GTX-10-OH, 11000BSA, MTP-11A BH-7487-42 - Short BH-7487-43 - Long</p> 
---	---

More Rubber Pads and Adapters for Tuxedo Lifts and other makes and models are available!

See the front of this catalog and contact SVI if you don't see what you need.

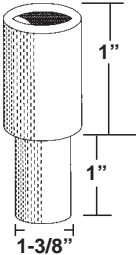
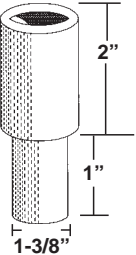
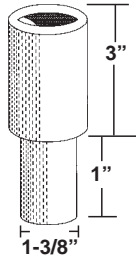
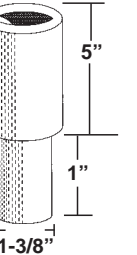
<p>BH-7485-0108A (Ref TP9-1038.1) 1" Nesting Style Height Extension. 1-3/8" (35 mm) Pin</p>  <p style="text-align: center;">Type NS</p>	<p>BH-7485-0109A (Ref TP9-1039.1) 2" Nesting Style Height Extension. 1-3/8" (35 mm) Pin</p>  <p style="text-align: center;">Type NS</p>	<p>BH-7485-0108 (Ref TP9-1038) 3" Nesting Style Height Extension. 1-3/8" (35 mm) Pin</p>  <p style="text-align: center;">Type NS</p>	<p>BH-7485-0109 (Ref TP9-1039) 5" Nesting Style Height Extension. 1-3/8" (35 mm) Pin</p>  <p style="text-align: center;">Type NS</p>
--	--	--	---



Height Extensions and Adapters For W-K Rolling Bridge Jacks

Please always confirm dimensions before ordering. Height Extensions and Adapters come in many different styles and dimensions. SVI is well-known as the adapter expert, specializing in top quality standard and custom adapters. SVI is your answer.



MANY MORE AVAILABLE!

See common adapters and pads at the beginning of this catalog:
 Height Extensions & Adapters By Type / Style
 Includes Nesting Style Height Extensions, Nesting Pad Adapters,
 Slip-On Style, Drop-On Style, Adjustable and Fixed Adapters, and more!



For W-K - Rolling Bridge Jacks

For 6,000 LB. ROLLING JACKS

Also for MLM Rolling Bridge Jacks

<p>Low Adapter (Ref ML-06RAJ-006) BH-7773-20: Without Pad ML-06RAJ-006P: With Pad</p> <div style="text-align: center;">  </div> <p style="text-align: center;">Adapter with Pad Pictured</p>	<p>High Adapter (Ref ML-06RAJ-007) BH-7773-21: Without Pad ML-06RAJ-007P: With Pad</p> <div style="text-align: center;">  </div> <p style="text-align: center;">Adapter with Pad Pictured</p>
--	---

For 12,000 LB. ROLLING JACKS

Also for MLM Rolling Bridge Jacks

<p>Low Adapter for 12,000 lb (Ref ML-12RAJ-006) BH-7773-22 Without Pad Also Available: With Pad</p>	<p>High Adapter for 12,000 lb (Ref ML-12RAJ-007) BH-7773-23 Without Pad Also Available: With Pad</p>	<p>4" Adapter Without Rubber Pad BH-7773-25 (Ref ML-12RAJ-009)</p>	<p>8" Adapter Without Rubber Pad BH-7773-26 (Ref ML-12RAJ-010)</p>
<p>5" Adapter with Rubber Pad BH-7773-27 (Ref 111P)</p>	<p>Pin Adapter without Rubber Pad (Ref ML-12RAJ-008) BH-7773-24 Without Pad</p>		



Height Extensions and Adapters For Weaver Lifts

Please always confirm dimensions before ordering. Height Extensions and Adapters come in many different styles and dimensions. SVI is well-known as the adapter expert, specializing in top quality standard and custom adapters. SVI is your answer.



MANY MORE AVAILABLE!
 See common adapters and pads at the beginning of this catalog:
 Height Extensions & Adapters By Type / Style
 Includes Nesting Style Height Extensions, Nesting Pad Adapters,
 Slip-On Style, Drop-On Style, Adjustable and Fixed Adapters, and more!



Additional Height Extensions for Weaver Lifts

For LIFTS WITH FLIP-UP STYLE ADAPTERS - MANY MODELS

SPCW1 Slip-Over Protective Pad
 Drop-On Protective Rectangle Rubber Pad Adapter for Flip-Up
 Protects Vehicle Undercoating
 BH-9681-06 • 1" Height

Fits over Flip Up Adapters

Opening Dimensions:
 5-7/8" x 1"
 Type
 SPCW1

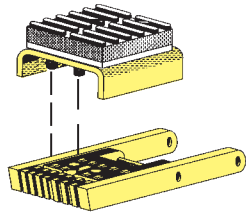

*Pictured on Flip-Ups,
 Sold Separately.*

Replaceable Pad: BH-7101-00

SPCW Slip-Over Protective Pad - FIXED
 Drop-On FIXED Height Extension with Pad for Flip-Ups

BH-9681-01 • 3" Adapter
 BH-9681-02 • 4" Adapter
 BH-9681-03 • 5" Adapter
 BH-9681-04 • 6" Adapter

Fits over Flip Up Adapters

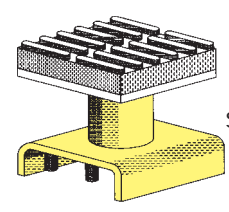

Type
 SPCW

Opening Dimensions:
 5-7/8" x 1"

Replaceable Pad: BH-7101-00

ASPCW Slip-Over Protective Pad-ADJ.
 4" to 6" Drop-On ADJUSTABLE Height Extension with
 Rectangle Rubber Arm Pad
 BH-9681-05

Fits over Flip Up Adapters

Opening Dimensions:
 5-7/8" x 1"



TYPE
 ASPCW

Pictured on Flip-Ups, Sold Separately.

Replaceable Pad: BH-7101-00

SONRW Narrow Drop-On Extension
 For Close to Frame Obstructions
 BH-9680-00 • 9" Drop-On Height Extension with Rectangle Pad

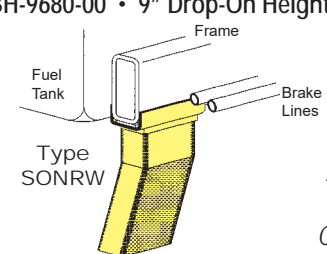

Opening Dimensions:
 5-5/8" x 1-3/16"

Fits over Flip Up Adapters

Avoids denting or puncturing fuel tank and smashing brake lines. Commonly sold for use on the rear of late model trucks and SUVs.

Replaceable Pad: BH-9900-10

SOCW Drop-On Extension Without Pad
SOCWP Drop-On Extension With Pad

Drop-On Height Extension for Flip-Ups
 BH-9680-01 (Ref KL-305) 9" Tall • SOCW Style without Pad
 BH-9380-01A 11" Tall • SOCW Style without Pad
 BH-9680-01B (Ref KL-305x) 9" Tall • SOCWP Style with Pad
 BH-9380-01C 11" Tall • SOCWP Style with Pad

Fits over Flip Up Adapters

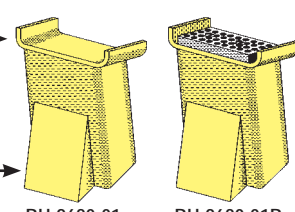

Inside Dimensions: 5-3/4" Wide

Opening Dimensions: 5-5/8" x 1-3/16"

BH-9680-01
 BH-9680-01A
 Type
 SOCW

BH-9680-01B
 BH-9680-01C
 Type
 SOCWP

NOTE: Also available as wide style GMT Adapters for use with 2019, 2020, and newer Chevrolet 1500 Silverado and GMC Sierra Trucks.

For SOCWP, Replacement Rubber Pad: BH-9900-10 (3" x 5" x 3/8")



Height Extensions and Adapters For Werther Lifts

Please always confirm dimensions before ordering. Height Extensions and Adapters come in many different styles and dimensions. SVI is well-known as the adapter expert, specializing in top quality standard and custom adapters. SVI is your answer.



MANY MORE AVAILABLE!
 See common adapters and pads at the beginning of this catalog:
 Height Extensions & Adapters By Type / Style
 Includes Nesting Style Height Extensions, Nesting Pad Adapters,
 Slip-On Style, Drop-On Style, Adjustable and Fixed Adapters, and more!



Additional Height Extensions for Werther Lifts VARIOUS MODELS

FOR WERTHER
 Adjustable Slip-On Height Extension with Octagon Pad

BH-7587-12 • 4"–6" Adjustable
 BH-7587-13 • 6"–9-1/2" Adjustable

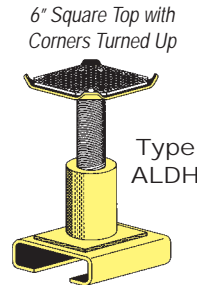

6" Square Top with
Corners Turned Up

Type
ALDH

Opening Dimensions:
5-5/8" x 1-3/16"

Replacement Pad—See BH-7225-01

FOR WERTHER LIFTS
 Slip-On Narrow Height Extension for Close to Frame Obstructions

BH-7587-14 • 3" Extension
 BH-7587-15 • 6" Extension
 BH-7587-16 • 9" Extension

Adjustable version also available.

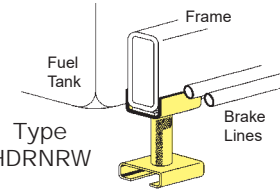

Fuel Tank

Frame

Brake Lines

Type
HDRNRW

Opening Dimensions:
5-5/8" x 1-3/16"

Replacement Pad Available

FOR WERTHER LIFTS
 Adjustable Slip-On Narrow Height Extension for Close to Frame Obstructions

BH-7587-17 • 4"–6" Adjustable
 BH-7587-18 • 6"–9" Adjustable

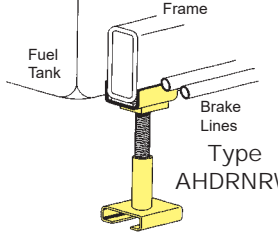

Fuel Tank

Frame

Brake Lines

Type
AHDRNRW

Opening Dimensions:
5-5/8" x 1-3/16"

Replacement Pad: BH-9755-50-1



Height Extensions and Adapters For Western Hoist

Please always confirm dimensions before ordering. Height Extensions and Adapters come in many different styles and dimensions. SVI is well-known as the adapter expert, specializing in top quality standard and custom adapters. SVI is your answer.







MANY MORE AVAILABLE!
 See common adapters and pads at the beginning of this catalog:
 Height Extensions & Adapters By Type / Style
 Includes Nesting Style Height Extensions, Nesting Pad Adapters,
 Slip-On Style, Drop-On Style, Adjustable and Fixed Adapters, and more!

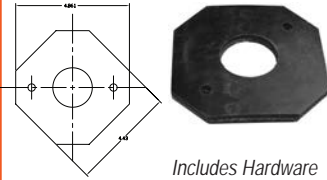

Additional Height Extensions for Western Hoist

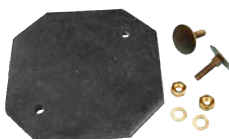
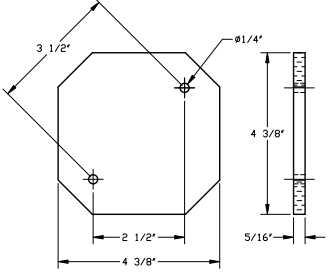
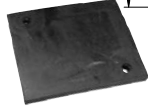
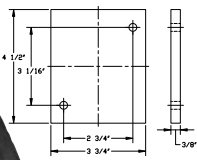
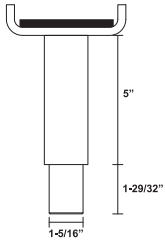
VARIOUS MODELS

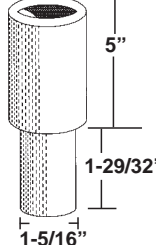
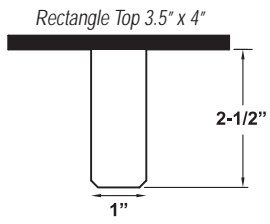
<p>Nesting Adapter Screw Base with Center Hole For Before 1/1/2000 BH-7771-31S (Ref S-2000TP)</p> <p style="text-align: center;">1-5/8"-8 Threads</p> <p style="text-align: center;">Use with Pad: BH-7771-32H</p>	<p>Bolt-On Octagon Rubber Pad with Center Hole (Before 01-01-2000) (Ref S-2001x) BH-7771-32H 1 Pad</p> <div style="text-align: center;">  <p>Includes Hardware</p> </div>	<p>Arm Pad Adapter with Replaceable Pad with 1-3/8" (35 mm) Pin Dia. (Ref 5170105x)</p> <p>BH-7475-01R Adapter and Pad BH-7101-00 Replacement Rubber Pad Only BH-7475-01-4 Replacement Rubber Pad Kit of 4 Rubber Pads & Fasteners for 7475-01R</p> <div style="display: flex; align-items: center;"> <div style="text-align: center; margin-right: 10px;">  <p>(Ref 5170105)</p> </div> <div style="margin-right: 10px;"> <p>◀ If you had this old molded style, now order # BH-7475-01R</p> </div> <div style="text-align: center;">  <p>1-3/8"</p> </div> </div>
<p>Y2K Pad Adapter For After 1/1/2000 BH-7771-31 (Ref S-2000)</p> <p style="text-align: center;">Use with Pad: BH-7771-32</p>	<p>Bolt-On Octagon Rubber Pad without Hole for Use After Date 01-01-2000 (Ref S-2001) BH-7771-32 1 Pad BH-7771-32-4 Kit of 4 Pads</p> <div style="display: flex; align-items: center;"> <div style="text-align: center; margin-right: 20px;">  <p>Includes Hardware</p> </div> <div>  </div> </div>	
<p>Bolt-On Rectangle Rubber Pad for WSO-90A / Y2K, SVT-1 (Ref S-2002) BH-7771-51P 1 Pad</p> <div style="display: flex; align-items: center;"> <div style="text-align: center; margin-right: 10px;">  </div> <div>  </div> </div>	<p>Height Adapter for WSO-90A / Y2K BH-7771-51 (Ref SVT-1)</p> <div style="text-align: center;">  <p>Replaceable Pad BH-7771-51P</p> </div>	<p>Nesting Style Height Extension (Ref SVT-2) BH-7771-52 5" Adapter BH-7771-52A 3" Adapter</p> <div style="display: flex; align-items: center;"> <div style="text-align: center; margin-right: 20px;">  <p>Roll Pin on Bottom Type NS</p> </div> <div style="text-align: center;">  </div> </div>
<p>BH-7760-40 Adapter Base for Rolling Jack (no pad) - For Holmac</p> <div style="text-align: center;">  <p>Rectangle Top 3.5" x 4" 2-1/2" 1" Pin Diameter</p> </div>		

Height Extensions and Adapters For Western Hoist

Please always confirm dimensions before ordering. Height Extensions and Adapters come in many different styles and dimensions. SVI is well-known as the adapter expert, specializing in top quality standard and custom adapters. SVI is your answer.





MANY MORE AVAILABLE!
See common adapters and pads at the beginning of this catalog:
Height Extensions & Adapters By Type / Style
Includes Nesting Style Height Extensions, Nesting Pad Adapters,
Slip-On Style, Drop-On Style, Adjustable and Fixed Adapters, and more!



Additional Height Extensions for Western Hoist

For LIFTS WITH FLIP-UP STYLE ADAPTERS - MANY MODELS

SPW1 Slip-Over Protective Pad
Drop-On Protective Rectangle Rubber Pad Adapter for Flip-Up
Protects Vehicle Undercoating
BH-9712-13 • 1" Height

Fits over Flip Up Adapters



Type SPW1

Opening Dimensions:
5-1/4" x 1-3/16"

Replaceable Pad: BH-7101-00

SOM Drop-On Extension Without Pad
SOMP Drop-On Extension With Pad

Drop-On Height Extension for Flip-Ups
BH-9712-07 9" Tall • SOM Style without Pad
BH-9712-07A 9" Tall • SOMP Style with Rectangle Pad

Inside Dimensions:
5-5/8" Wide

Opening Dimensions:
5-5/8" x 1-5/8"

Fits over Flip Up Adapters



BH-9712-07 Type SOM

BH-9712-07A Type SOMP

NOTE: Also available as wide style GMT Adapters for use with 2019, 2020, and newer Chevrolet 1500 Silverado and GMC Sierra Trucks.

For SOMP, Replacement Rubber Pad: BH-9900-10 (3" x 5" x 3/8")

SOWNA Screw-Up Drop-On - ADJ.

Slip-Over Adjustable Spin-Up Height Extension
with Heavy Duty Octagon Pad
BH-9712-07N

Fits over Flip Up Adapters

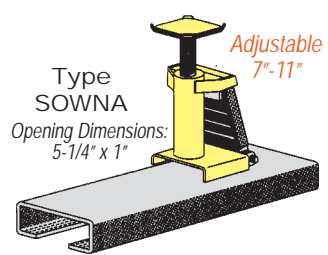

Type SOWNA

Adjustable 7"-11"

Opening Dimensions:
5-1/4" x 1"

With Octagon Pad
Replaceable Pad: BH-7235-90AX



Height Extensions and Adapters For Wheeltronic Lifts

Please always confirm dimensions before ordering. Height Extensions and Adapters come in many different styles and dimensions. SVI is well-known as the adapter expert, specializing in top quality standard and custom adapters. SVI is your answer.



MANY MORE AVAILABLE!

See common adapters and pads at the beginning of this catalog:
 Height Extensions & Adapters By Type / Style
 Includes Nesting Style Height Extensions, Nesting Pad Adapters,
 Slip-On Style, Drop-On Style, Adjustable and Fixed Adapters, and more!



Additional Height Extensions for Wheeltronic Lifts and Others FOR VARIOUS MODELS

Wheeltronic private-labeled lifts for many other companies including Ammco®* / Hennessy, Hofmann, John Bean (JBC), Magnum, Pepboys, Snap-On, TAG, Sun, others

Rectangular Adapter Base with Pad (Ref 2-1993)
 Various Options Available including Pad Choice and Step/Height
 Pin Diameter: 1-1/4"

Top Pad: 4-7/8" x 3-7/8"



Adapter with BH-7101-00 Pad

Top Pad: 5-1/4" x 4-1/4"



Adapter with BH-7805-168 Pad

BH-7796-10B • 1/2" Step	BH-7796-10AP • 1/2" Step
BH-7796-10NS • No Step (Base Only)	BH-7793-56 • No Step
BH-7796-10C • 1" Step (Base Only)	BH-7796-10C • 1" Step (Base Only)
BH-7796-10T • 3" Step (Base Only)	BH-7796-10T • 3" Step (Base Only)

SVI Part #	Ref #	Description
BH-7796-10B	2-1993x	Rectangular Adapter Base—With 1/2" Step With Pad <i>BH-7101-00</i>
BH-7796-10AP	2-1993x	Rectangular Adapter Base—With 1/2" Step With Pad <i>BH-7805-168</i>
BH-7796-10	2-1993	Rectangular Adapter Base Only—With 1/2" Step
BH-7796-10C	2-1993x	Rectangular Adapter Base Only—With 1" Step
BH-7796-10T	2-1993x	Rectangular Adapter Base Only—With 3" Step
BH-7793-56	1-3278	Rectangular Adapter—No Step with Pad BH-7805-168
BH-7796-10NS	2-1993x	Rectangular Adapter Base Only—No Step

Do you use these Adapters, but need a Wider Lifting Base for Lifting Newer Chevy 1500 Silverado and GM Sierra Trucks? See BH-7796-10GMT

BH-7793-45 (Ref 1-1993)
 3-1/4" Nesting Style Height Extension / Stack Pad Adapter

Type NS



BH-7793-45L (Ref 1-1993)
 4-1/2" Nesting Style Height Extension / Stack Pad Adapter

Type NS

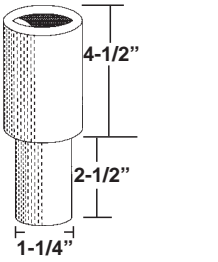

BH-7796-04 (Ref 2-1580)
 6" Nesting Style Height Extension / Stack Pad Adapter

Type NS



Specialty Wide Adapter for 2019, 2020 and newer Chevrolet 1500 Silverado and GM Sierra Trucks - 1-1/4" Pin Dia.
Features 7" Wide Lifting Area • Ref 2-1993x

- BH-7796-10GMT (1) Adapter Base and Pad
- BH-7796-10GMT-2 (2) Adapter Bases and Pads
- BH-7542-75P Replacement Pad Only
- BH-7542-75P-4 Replacement Pads (Set of 4)

TYPE
GMT

7" Wide Lifting Area



1-1/4" Pin Dia.



Height Extensions and Adapters For Wheeltronic Lifts

Please always confirm dimensions before ordering. Height Extensions and Adapters come in many different styles and dimensions. SVI is well-known as the adapter expert, specializing in top quality standard and custom adapters. SVI is your answer.





MANY MORE AVAILABLE!
 See common adapters and pads at the beginning of this catalog:
 Height Extensions & Adapters By Type / Style
 Includes Nesting Style Height Extensions, Nesting Pad Adapters,
 Slip-On Style, Drop-On Style, Adjustable and Fixed Adapters, and more!



Additional Height Extensions for Wheeltronic Lifts and Others FOR VARIOUS MODELS

Wheeltronic private-labeled lifts for many other companies including Ammco® / Hennessy, Hofmann, John Bean (JBC), Magnum, Pepboys, Snap-On, TAG, Sun, others

BH-7793-94 (Ref 2-0304)
 Standard Low Lifting Pad
 4" Screw Up Adapter



Replaceable Pad: BH-7235-90A

Screw Up Height Extension with 4" x 4.5" Rectangle Slip On Pad
 1-1/4"-7 Threads
 Replaces Ref 3-0170 (BH-7090-80)

SVI Part #	Height	Threads
BH-7090-80	4"	1-1/4"-7
BH-7090-81	5"	1-1/4"-7
BH-7090-82	6"	1-1/4"-7
BH-7090-83	7"	1-1/4"-7
BH-7090-84	8"	1-1/4"-7

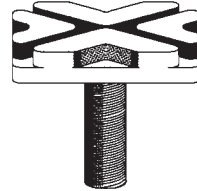

Type
SURX



Features BH-7750-02 Replaceable Rubber Pad

BH-7796-48 (Ref 3-0194)
 6" Height Extension

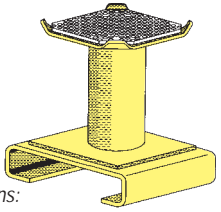

Opening
 Dimensions:
 4-5/8" x 1-5/16"

Replaceable Pad: BH-7235-90A



Height Extensions and Adapters For Wheeltronic Lifts

Please always confirm dimensions before ordering. Height Extensions and Adapters come in many different styles and dimensions. SVI is well-known as the adapter expert, specializing in top quality standard and custom adapters. SVI is your answer.



MANY MORE AVAILABLE!

See common adapters and pads at the beginning of this catalog:
 Height Extensions & Adapters By Type / Style
*Includes Nesting Style Height Extensions, Nesting Pad Adapters,
 Slip-On Style, Drop-On Style, Adjustable and Fixed Adapters, and more!*



For Wheeltronic Lifts and Snap-On Lifts

For LIFTS WITH FLIP-UP STYLE ADAPTERS - MANY MODELS

Wheeltronic private-labeled lifts for many other companies including Ammco®* / Hennessy, Hofmann, John Bean (JBC), Magnum, Pepboys, Snap-On, TAG, Sun, others

BH-7797-38 (Ref 3-0583)
Low Step Position Adapter
Also replaces ref 2-0532
Old Style—If lift still has old style, you must also replace high step to mate properly.



BH-7797-37 (Ref 3-0582)
High Step Position Adapter
Also replaces ref 3-0342
Old Style—If lift still has old style, you must also replace low step to mate properly.



BH-7797-37P SVI Exclusive
Rubber Adapter Pad for Wheeltronic Lifts
Fits over high step adapter

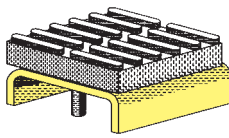

Fits over Flip Up Adapters

Drop-On FIXED Height Extension with Pad
Drop-On 6" Fixed Height Extension with Pad for Wheeltronic and Snap-On Lifts
BH-7798-19 • 6" Adapter



Fits over Flip Up Adapters
BH-7797-37 (Ref 3-0582)

Replaceable Pad: BH-9755-50-1

SOWNA Screw-Up Drop-On - ADJ.

Slip-Over Adjustable Spin-Up Height Extension with Octagon Pad
BH-7790-00

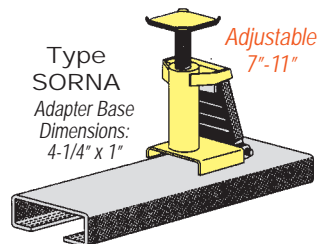

Fits over Flip Up Adapters

With Octagon Pad
Replaceable Pad: BH-7235-90A

Type SORNA Adapter Base Dimensions: 4-1/4" x 1" Adjustable 7"-11"

Specialty Wide Adapter for 2019, 2020 and newer Chevrolet 1500 Silverado and GM Sierra Trucks
Features 7" Wide Lifting Area

BH-7798-19GMT Flip-Up Adapter Height Extension KIT (2 Front / 2 Rear)

BH-7798-19GMT-F (1) 7" Height Extension - FRONT
BH-7798-19GMT-R (1) 8" Height Extension - REAR



TYPE GMT

7" Wide Lifting Area

BH-7790-00MR
Slip Over Adjustable with Heavy Duty Octagon Pad For Mid Rise



Fits over Flip Up Adapters

Adjustable 7"-10"

Adapter Base Dimensions: 5" x 1"

Replaceable Pad: BH-7235-90AX

P a g e

152 **More Styles Available—See common "Height Extensions & Adapters By Type / Style" at the beginning of this catalog!**



Height Extensions and Adapters For Wheeltronic Lifts

Please always confirm dimensions before ordering. Height Extensions and Adapters come in many different styles and dimensions. SVI is well-known as the adapter expert, specializing in top quality standard and custom adapters. SVI is your answer.



MANY MORE AVAILABLE!
 See common adapters and pads at the beginning of this catalog:
 Height Extensions & Adapters By Type / Style
 Includes Nesting Style Height Extensions, Nesting Pad Adapters,
 Slip-On Style, Drop-On Style, Adjustable and Fixed Adapters, and more!

For Wheeltronic Lift - Rolling Jack

FOR VARIOUS MODELS

Wheeltronic private-labeled lifts for many other companies including Ammco®* / Hennessy, Hofmann, John Bean (JBC), Magnum, Pepboys, Snap-On, TAG, Sun, others

BH-7795-33
 (Ref 2-0264, 2-1174)
 Rolling Jack Adapter
 with Rubber Pad



Replaceable Pad: BH-7101-00

Height Extensions and Adapters By Size

Please always confirm dimensions before ordering. Height Extensions and Adapters come in many different styles and dimensions. SVI is well-known as the adapter expert, specializing in top quality standard and custom adapters. SVI is your answer.

1-1/8" Pin OD Pin Length Varies

For Some Models:
Mohawk, Weaver

BH-7340-15BK
(Ref 025-002-026)
Height Extension Bracket
for 1-1/8" Adapters

Nesting Style Height Extension for Weaver

BH-7606-36 (ref 1086636)	2-1/2" Extension
BH-7606-37	3" Extension
BH-7606-38	4" Extension
BH-7606-35 (ref 1086635)	5" Extension
BH-7606-39	6" Extension

Type NS 1-1/8"

BH-7340-12 (Ref 025-002-127)
3" Nesting Style Height
Extension - 1-1/8" Pin Dia.

Type NS 1-1/8"

BH-7340-13 (Ref)
4" Nesting Style Height
Extension - 1-1/8" Pin Dia.

Type NS 1-1/8"

BH-7340-14 (Ref)
5" Nesting Style Height
Extension - 1-1/8" Pin Dia.

Type NS 1-1/8"

BH-7340-15 (Ref 025-002-128)
6" Nesting Style Height
Extension - 1-1/8" Pin Dia.

Type NS 1-1/8"

Nesting Style Adapter with Pad - 1-1/8" Pin Dia.
****Alternative Pad to Steel Teeth Pad** (Ref 025-002-035)
For use with System 1A, others

BH-7340-11	Adapter with Pad
BH-7101-00	Replacement Pad Only

Alternative to:
BH-7341-58 Steel Tooth Pad
(ref 025-002-035) Not Shown

1-1/8"

1-1/2" Riser Nesting Style Adapter with Pad - 1-1/8" Pin Dia.
For use with System 1A, others

BH-7340-40	Adapter with Pad 1-1/2" Riser
BH-7101-00	Replacement Pad Only

1-1/8"

Specialty Wide Adapter for 2019, 2020 and newer Chevrolet
1500 Silverado and GM Sierra Trucks - 1-1/8" (35 mm) Pin Dia.
Features 7" Wide Lifting Area. 1-1/8" Pin dia. x 2-1/4" Long Pin

BH-7341-58GMT-1	(1) Adapter Base with Pad
BH-7341-58GMT	Adapter Base with Pad (Set of 2)
BH-7542-75P	Replacement Pad Only
BH-7542-75P-4	Replacement Pads (Set of 4)

Pin: 1-1/8" Dia. x 2-1/4" Long

Nesting Style Narrow Top with 1-1/8" Pin Diameter
For close to frame obstructions. For use on the rear of late model trucks. Avoids denting or puncturing fuel tank and smashing brake lines. Adapter has a 4-1/2" x 3" rectangular top formed from heavy 3/16" and 3/8" steel plate with a replaceable rubber pad.

BH-7091-59	Nesting Adapter (Narrow Top) with Pad 1-1/8" Pin
BH-9900-10A	Replacement Rubber Pad Only







Type NSPNRW
Narrow

Height Extensions and Adapters By Size

Please always confirm dimensions before ordering. Height Extensions and Adapters come in many different styles and dimensions. SVI is well-known as the adapter expert, specializing in top quality standard and custom adapters. SVI is your answer.

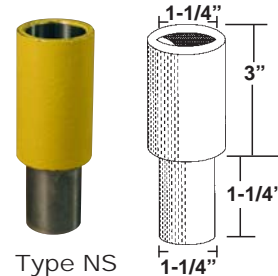
1-1/4" Pin OD Pin Length Varies

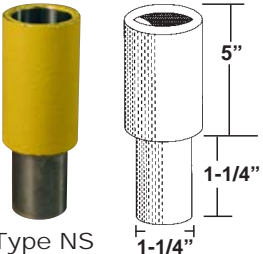
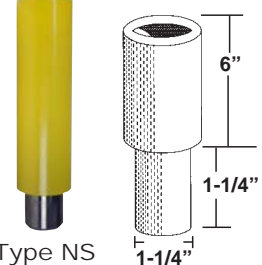
For Some Models:
Forward Lifts

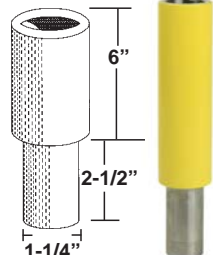
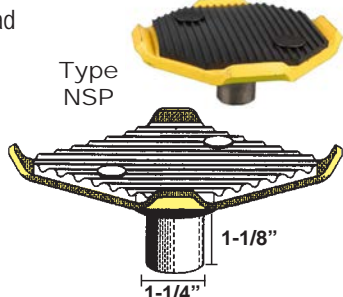
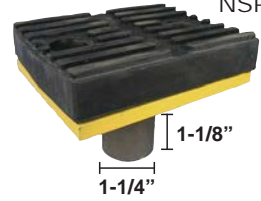
<p>Nesting Height Extension Kit for Forward Lifts 1-1/4" Pin Diameter</p> <p>BH-7239-120 (Ref 994257) Kit Includes 4 Each of 1-1/2", 3" and 6" Adapters</p>  <p>Type NSP</p>	<p>BH-7235-72 (Ref 996220) 1-1/2" Nesting Style Height Extension</p>  <p>Type NS</p>	<p>BH-7089-98 (Ref 995560) 3" Nesting Style Height Extension</p>  <p>Type NS</p>	<p>BH-7089-99 4" Nesting Style Height Extension</p>  <p>Type NS</p>
<p>BH-7089-99A 5" Nesting Style Height Extension</p>  <p>Type NS</p>	<p>BH-7089-99B (Ref 995550) 6" Nesting Style Height Extension</p>  <p>Type NS</p>	<p>BH-7793-45 (Ref 1-1993) 3-1/4" Nesting Style Height Extension / Stack Pad Adapter</p>  <p>Type NS</p>	<p>BH-7793-45L (Ref 1-1993x) 4-1/2" Nesting Style Height Extension / Stack Pad Adapter</p>  <p>Type NS</p>
<p>BH-7796-04 (Ref 2-1580) 6" Nesting Style Height Extension / Stack Pad Adapter</p>  <p>Type NS</p>	<p>Nesting Adapter Pad for Forward Lifts (Ref 106605) Features 5-1/2" Square Top with Corners Turned Up</p> <p>BH-7089-97 Adapter and Pad</p>  <p>Type NSP</p> <p>For those that prefer a thicker, longer lasting pad, see BH-7089-97R.</p> <p>Replacement Pad: BH-7235-90A</p>		<p>Rectangle Adapter Base & Pad Assembly 1-1/4" Pin Diameter</p> <p>BH-7089-97R Type NSP</p>  <p>Replacement Pad: BH-7101-00</p>



Height Extensions and Adapters By Size

Please always confirm dimensions before ordering. Height Extensions and Adapters come in many different styles and dimensions. SVI is well-known as the adapter expert, specializing in top quality standard and custom adapters. SVI is your answer.

1-1/4" Pin OD Pin Length Varies

For Some Models:
Forward Lifts

Round Lift Pad Adapter with 1-1/4" Pin
BH-7235-94RC



Type NSP

Replacement Pad: BH-7474-78

Nesting Style Adapter with 5" Top
1-1/4" Pin Diameter

BH-7091-53

Type NSP

Nesting Style Narrow Top with 1-1/4" Pin Diameter

For close to frame obstructions. For use on the rear of late model trucks. Avoids denting or puncturing fuel tank and smashing brake lines. Adapter has a 4-1/2" x 3" rectangular top formed from heavy 3/16" and 3/8" steel plate with a replaceable rubber pad.

BH-7091-58 Nesting Adapter (Narrow Top) with Pad 1-1/4" Pin

BH-9900-10A Replacement Rubber Pad Only

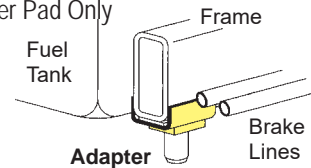

Type NSPNRW

Rectangular Adapter Base with Pad (Ref 2-1993)
Various Options Available including Pad Choice and Step/Height
Pin Diameter: 1-1/4"

Top Pad: 4-7/8" x 3-7/8"



Top Pad: 5-1/4" x 4-1/4"



Adapter with BH-7101-00 Pad

BH-7796-10B • 1/2" Step

BH-7796-10NS • No Step (Base Only)

BH-7796-10C • 1" Step (Base Only)

BH-7796-10T • 3" Step (Base Only)

Adapter with BH-7805-168 Pad

BH-7796-10AP • 1/2" Step

BH-7793-56 • No Step

BH-7796-10C • 1" Step (Base Only)

BH-7796-10T • 3" Step (Base Only)

SVI Part #	Ref #	Description
BH-7796-10B	2-1993x	Rectangular Adapter Base—With 1/2" Step With Pad BH-7101-00
BH-7796-10AP	2-1993x	Rectangular Adapter Base—With 1/2" Step With Pad BH-7805-168
BH-7796-10	2-1993	Rectangular Adapter Base Only—With 1/2" Step
BH-7796-10C	2-1993x	Rectangular Adapter Base Only—With 1" Step
BH-7796-10T	2-1993x	Rectangular Adapter Base Only—With 3" Step
BH-7793-56	1-3278	Rectangular Adapter—No Step with Pad BH-7805-168
BH-7796-10NS	2-1993x	Rectangular Adapter Base Only—No Step

Do you use these Adapters, but need a Wider Lifting Base for Lifting Newer Chevy 1500 Silverado and GM Sierra Trucks? See BH-7796-10GMT

Specialty Wide Adapter for 2019, 2020 and newer Chevrolet 1500 Silverado and GM Sierra Trucks - 1-1/4 Pin Diameter
Features 7" Wide Lifting Area

BH-7089-97GMT-1 (1) Adapter with 1-1/4" Pin & Pad

BH-7089-97GMT-2 Set of (2) Adapters with 1-1/4" Pin & Pad

BH-7542-75P Replacement Pad Only

BH-7542-75P-4 Replacement Pads (Set of 4)



1-1/4 Pin Diameter
1-3/16" Pin Length



Specialty Wide Adapter for 2019, 2020 and newer Chevrolet 1500 Silverado and GM Sierra Trucks - 1-1/4" Pin Dia.
Features 7" Wide Lifting Area • Ref 2-1993x

BH-7796-10GMT (1) Adapter Base and Pad

BH-7796-10GMT-2 (2) Adapter Bases and Pads

BH-7542-75P Replacement Pad Only

BH-7542-75P-4 Replacement Pads (Set of 4)



1-1/4 Pin Diameter
2-1/2" Pin Length



Height Extensions and Adapters By Size

Please always confirm dimensions before ordering. Height Extensions and Adapters come in many different styles and dimensions. SVI is well-known as the adapter expert, specializing in top quality standard and custom adapters. SVI is your answer.

1-3/8" Pin OD / 35mm Pin OD Pin Length Varies For Some Models: BendPak, Dannmar, Globe, Magnum, Mohawk, Pro-Lift, Others

<p>BH-7090-10 (Ref 5746390, 66501) 3" Nesting Style Height Extension. 1-3/8" (35 mm) Pin</p>  <p>Type NS</p>	<p>BH-7090-11 4" Nesting Style Height Extension. 1-3/8" (35 mm) Pin</p>  <p>Type NS</p>	<p>BH-7090-12 5" Nesting Style Height Extension. 1-3/8" (35 mm) Pin</p>  <p>Type NS</p>	<p>BH-7479-95 (Ref 5746395) 5-3/4" Nesting Style Height Extension. 1-3/8" (35 mm) Pin</p>  <p>Type NS</p>
<p>BH-7090-13 (Ref 81691, 27982, 66502) 6" Nesting Style Height Extension. 1-3/8" (35 mm) Pin</p>  <p>Type NS</p>	<p>BH-7485-0108A (Ref TP9-1038.1) 1" Nesting Style Height Extension. 1-3/8" (35 mm) Pin</p>  <p>Type NS</p>	<p>BH-7485-0109A (Ref TP9-1039.1) 2" Nesting Style Height Extension. 1-3/8" (35 mm) Pin</p>  <p>Type NS</p>	<p>BH-7485-0108 (Ref TP9-1038) 3" Nesting Style Height Extension. 1-3/8" (35 mm) Pin</p>  <p>Type NS</p>
<p>BH-7485-0109 (Ref TP9-1039) 5" Nesting Style Height Extension. 1-3/8" (35 mm) Pin</p>  <p>Type NS</p>	<p>Arm Pad Adapter with Replaceable Pad with 1-3/8" (35 mm) Pin Dia. (Ref 5170105x)</p> <p>BH-7475-01R Adapter and Pad BH-7101-00 Replacement Rubber Pad Only BH-7475-01-4 Replacement Rubber Pad Kit of 4 Rubber Pads & Fasteners for 7475-01R</p>  <p>(Ref 5170105) ◀ If you had this old rubber molded-on steel style, now order # BH-7475-01R</p>  <p>Type NSP</p>		
<p>Round Lift Pad Adapter with 1-3/8" (35 mm) Pin (Ref 5215507)</p> <p>BH-7474-79C Adapter and Pad BH-7474-79 Adapter Only (without pad) BH-7474-80C Adapter and Pad - 1-11/16" Taller BH-7474-80 Adapter Only - 1-11/16" Taller BH-7474-78 Replacement Pad Only</p>  <p>Type NSP</p>		<p>Adapter with Square Pad with 1-3/8" (35 mm) Diameter Pin</p> <p>BH-7475-28 (Ref 5210700) Individual Adapter & Pad BH-7479-55 (Ref 5715365) Replacement Pad Only</p>  <p>Type NSP</p>	

Height Extensions and Adapters By Size

Please always confirm dimensions before ordering. Height Extensions and Adapters come in many different styles and dimensions. SVI is well-known as the adapter expert, specializing in top quality standard and custom adapters. SVI is your answer.

1-3/8" Pin OD / 35mm Pin OD Pin Length Varies For Some Models: BendPak, Danmar, Globe Magnum, Mohawk, Pro-Lift, Others

Frame Cradle Adapter Base & Rubber Pad with 1-3/8" (35 mm) Diameter Pin

BH-7480-07 (Ref 17107022, 5215754) Adapter Base with Pad
 BH-7480-07-1 (Ref 17107021) Adapter Base Only
 BH-7256-20P (Ref 17108189) Replacement Pad Only

4.75" Flat
 1-3/8" Type NSP

Hex Adapter Base & Pad Assembly with 1-3/8" (35 mm) Pin Dia.
 5-1/2" Square Top with Turned Up Corners
 Uses Replacement Octagon Pad BH-7235-90A

5-1/2" 1-3/8" Type NSP

BH-7089-97-13 Adapter and Pad
 BH-7235-90A Replacement Octagon Pad
 BH-7235-90AX Replacement Octagon Pad - Heavy Duty

Specialty Wide Adapter for 2019, 2020 and newer Chevrolet 1500 Silverado and GM Sierra Trucks - 1-3/8" (35 mm) Pin Dia.
 Features 7" Wide Lifting Area

BH-7479-348GMT-1 (1) Adapter with 35mm Pin & Pad
 BH-7479-348GMT-2 (2) Adapters with 35mm Pin & Pad
 BH-7542-75P Replacement Pad Only
 BH-7542-75P-4 Replacement Pads (Set of 4)

1-3/8" (35 mm) Pin Dia.
 1-13/16" Pin Length

TYPE GMT
 7" Wide Lifting Area

Nesting Style Adjustable 1-3/8" (35 mm) Pin Dia.
 Adapter has a 5" x 4" rectangular top formed from heavy 3/8" steel plate with a replaceable rubber pad. Adapters adjust by simply turning the contact pad to the heights listed.

5" x 4" Heavy Duty

BH-7340-16 Adapter & Pad
 Adjusts 7-1/2" to 9-1/2"
 BH-7101-00 Replacement Rubber Pad Only

Nesting Style Narrow Top with 1-3/8" (35 mm) Pin Dia.
 For close to frame obstructions. For use on the rear of late model trucks. Avoids denting or puncturing fuel tank and smashing brake lines.

BH-7091-57 Nesting Adapter (Narrow Top) with Pad 1-3/8" Pin
 BH-9900-10A Replacement Rubber Pad Only

1-3/8" Pin Dia.
 1-13/16" Pin Length

Fuel Tank Frame Brake Lines Adapter

Type NSPNRW

Frame Cradle Adapter Base & Rubber Pad with 1-3/8" (35 mm) Diameter Pin

BH-7472-30 Adapter Base with Pad
 BH-7101-00 Replacement Pad Only

4.16" ID 1-1/2" 1-3/8"

Nesting Adapter 1-3/8" Pin OD x 3-3/8" Long Pin

BH-7536-92X (1) Adapter with 1-3/8" OD Pin

(Pad sold separately—Ask for Kit)
 Would Use Replaceable Pad: BH-7536-92P



1-3/8" (35 mm) Pin Dia.
 3-3/16" Pin Length
 1-3/8"

Height Extensions and Adapters By Size

Please always confirm dimensions before ordering. Height Extensions and Adapters come in many different styles and dimensions. SVI is well-known as the adapter expert, specializing in top quality standard and custom adapters. SVI is your answer.

1-1/2" Pin OD Pin Length Varies

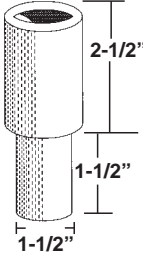
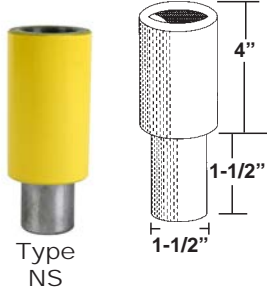
For Some Models: ALM, Ammco, Ben Pearson, Direct Lift, Rotary, others

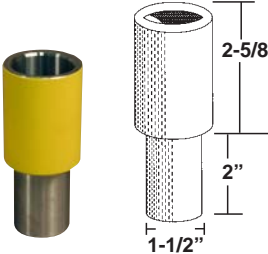
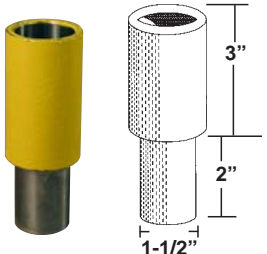
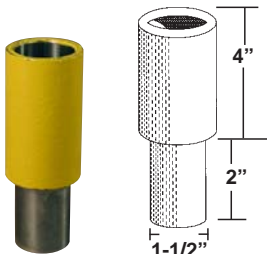
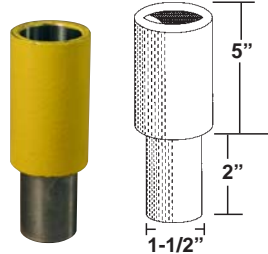
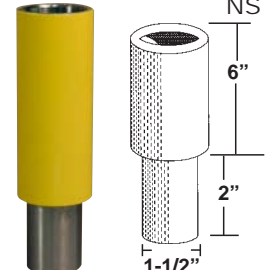
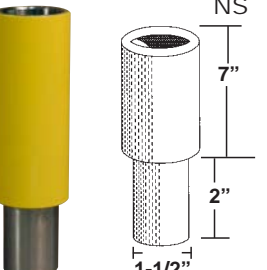
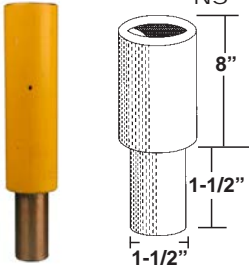
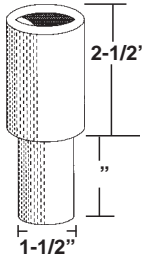
<p>Holder Bracket for Height Extensions with 1-1/2" Pin Diameters BH-7500-95 (Ref FJ6145)</p> 	<p>BH-7533-98S (Ref FJ6180) 2-1/2" Nesting Height Extension</p> <p>Type NS</p> 	<p>BH-7533-96 (Ref FJ6143) 4" Nesting Height Extension</p> 	
<p>BH-7101-02 (Ref 81693, 27984) 2-5/8" Nesting Style Height Extension</p> <p>Type NS</p> 	<p>BH-7090-14 3" Nesting Style Height Extension</p> <p>Type NS</p> 	<p>BH-7101-04 (Ref 81692) 3-1/2" Nesting Style Height Extension</p> <p>Type NS</p> 	<p>BH-7090-15 4" Nesting Style Height Extension</p> <p>Type NS</p> 
<p>BH-7101-03 (Ref 81691, 27982) 5" Nesting Style Height Extension</p> <p>Type NS</p> 	<p>BH-7090-16 6" Nesting Style Height Extension</p> <p>Type NS</p> 	<p>BH-7090-17 7" Nesting Style Height Extension</p> <p>Type NS</p> 	
<p>BH-7533-97 (Ref FJ6144) 8" Nesting Style Height Extension</p> <p>Type NS</p> 	<p>BH-7166-260 (Ref 209052B) 2-1/2" (63mm) Nesting Height Extension</p> <p>Type NS</p> 	<p>BH-7166-261 (Ref 209053B) 5" (127mm) Nesting Height Extension</p> <p>Type NS</p> 	



Height Extensions and Adapters By Size

Please always confirm dimensions before ordering. Height Extensions and Adapters come in many different styles and dimensions. SVI is well-known as the adapter expert, specializing in top quality standard and custom adapters. SVI is your answer.

1-1/2" Pin OD Pin Length Varies For Some Models: ALM, Ammco, Ben Pearson, Direct Lift, Rotary, others

BH-7101-01C
 (Ref 82591, 82361 - Base)
Adapter Base and Pad
 1-1/2" OD Pin
 1-13/16" Long Pin



Type NSP
 1-13/16"
 1-1/2"
 Replacement Pad: BH-7101-00

Hex Adapter Base & Pad Assembly with 1-1/2" Pin Dia.
 5-1/2" Square Top with Turned Up Corners
 Uses Replacement Octagon Pad BH-7235-90A

For those that prefer a thicker, longer lasting pad, see BH-7101-01C.

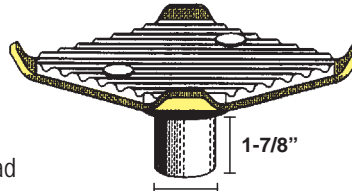

1-7/8"
 1-1/2"

BH-7089-97-15 Adapter and Pad
BH-7235-90A Replacement Octagon Pad
BH-7235-90AX Replacement Octagon Pad - Heavy Duty
 Type NSP

Nesting Style Adjustable Adapter with Pad
 1-1/2" Pin Dia.

Adapter has a 5" x 4" rectangular top formed from heavy 3/16" and 3/8" steel plate with a replaceable rubber pad. Adapters adjust by simply turning the contact pad to the heights listed.

BH-7091-70 Adjusts 5" to 6-3/4"
BH-7091-71 Adjusts 8" to 9-3/4"
BH-7091-72 Adjusts 10" to 12-3/4"
BH-7101-00 Replacement Rubber Pad Only



2-1/2"
 1-1/2"
 Heavy Duty

Specialty Wide Adapter for 2019, 2020 and newer Chevrolet 1500 Silverado and GM Sierra Trucks - 1-1/2" Pin OD
 Features 7" Wide Lifting Area • (Ref FJ6257, FJ6257KIT)

BH-7542-74K (2) Adapters with 1-1/2" OD Pin & Pad
BH-7542-74 (1) Adapter with 1-1/2" OD Pin & Pad
BH-7542-75P Replacement Pad Only
BH-7542-75P-4 Replacement Pad Kit (4)

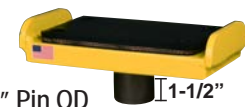

1-1/2" Pin OD
 1-1/2"

TYPE GMT
 7" Wide Lifting Area

BH-7091-56 Nesting Adapter with 1-1/2" Pin Dia. (Narrow Top)
 Top Dimensions: 2.88" ID x 4.5"

For close to frame obstructions

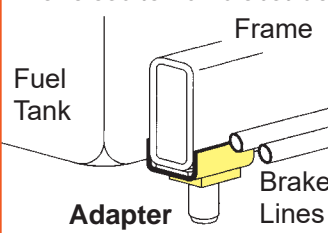

Frame
 Fuel Tank
 Adapter
 Brake Lines

Type NSPNRW Narrow
 Avoids denting or puncturing fuel tank and smashing brake lines. Adapter has a 4-1/2" x 3" rectangular top formed from heavy 3/16" and 3/8" steel plate with a replaceable rubber pad. Commonly sold for use on the rear of late model trucks.
 Replacement Pad: BH-9900-10A

BH-7166-246 (Ref 680030C)
Adapter Base Assembly with Round Pad

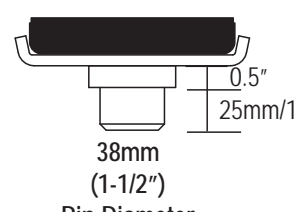

0.5"
 25mm/1"
 38mm (1-1/2")
 Pin Diameter

Replacement Pad: BH-7588-465

Call SVI (Ref 217114A)
Adapter Base Assembly with Round Pad - 1" Step

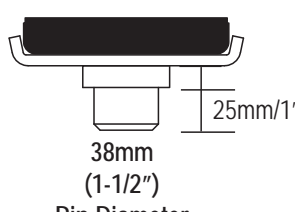

25mm/1"
 38mm (1-1/2")
 Pin Diameter

Replacement Pad: BH-7588-465

Specialty Frame Engaging Adapter for Challenger
 1-1/2" OD Pin

BH-7234-121P
 (Ref 10314xx, B2201x)



1-1/2" Pin Diameter

NOTE: Confirm Collar Pin OD before ordering. Also available as 2.359" OD.

BH-7536-92 (Ref FJ6158)
Lift Adapter Base Assembly with Rubber Pad



3-3/16"
 1-1/2"

Replacement Rubber Pad: BH-7536-92P
 Pad Dimensions: 4-1/8" x 3-1/4"

BH-9434-04 (Ref 060016C)
Complete Adapter Assembly



2"
 1-1/2"

Replacement Pad: BH-7205
 Pad Dimensions: 4-1/8" x 3-1/2"

BH-7101-01FC Adapter Base & Pad Assembly
 Replacement Pad: BH-7101-00
 Also See BH-7101-01C Above



BH-7101-01F (Ref 82361)
Adapter Base Only - Formed 1-1/2" Diameter Pin (No Pad)

Height Extensions and Adapters By Size

Please always confirm dimensions before ordering. Height Extensions and Adapters come in many different styles and dimensions. SVI is well-known as the adapter expert, specializing in top quality standard and custom adapters. SVI is your answer.

1-1/2" Pin OD Pin Length Varies

Adapter with Rubber Pad
 Features BH-7820-04 Octagon Rubber Arm Pad
 BH-7820-09 (Ref ALIF-209-086)

1-1/2" ID

Use with Height Extensions Below: BH-7820-15 thru BH-7820-19

For Some Models:
Whip Lifts



Made in the USA

BH-7820-15 thru -19

Nesting Style Height Extensions

2" Nesting Height Extension
 1-1/2" Diameter Pin
 BH-7820-15
 (Ref ALIF-209-076-XX)

Works with BH-7820-09 Adapter and Pad

4" Nesting Height Extension
 1-1/2" Diameter Pin
 BH-7820-16
 (Ref ALIF-209-077-XX)

Works with BH-7820-09 Adapter and Pad

6" Nesting Height Extension
 1-1/2" Diameter Pin
 BH-7820-17
 (Ref ALIF-209-078-XX)

Works with BH-7820-09 Adapter and Pad

8" Nesting Height Extension
 1-1/2" Diameter Pin
 BH-7820-18
 (Ref ALIF-209-210-XX)

Works with BH-7820-09 Adapter and Pad

10" Nesting Height Extension
 1-1/2" Diameter Pin
 BH-7820-19
 (Ref ALIF-209-205-XX)

Works with BH-7820-09 Adapter and Pad



Height Extensions and Adapters By Size

Please always confirm dimensions before ordering. Height Extensions and Adapters come in many different styles and dimensions. SVI is well-known as the adapter expert, specializing in top quality standard and custom adapters. SVI is your answer.

1.575" (40mm) Pin OD For Some Models: Stenhoj, Rotary, Forward Lifts

<p>Spin-Up Adapter (1) • BH-7588-29 1.57" (40mm) Pin Diameter • Pin Length 1-1/8"</p>  <p>Replaceable Rubber Arm Pad: BH-7450-02</p>	<p>BH-7548-004 (Ref V12TP-4410) Lift Pad Weldment 40mm (1.575") Pin Diameter <i>Pad Sold Separately</i></p>  <p>Type NSP 1.575" Dia. (40mm)</p> <p>Use with Pad BH-7270-048 or BH-7820-04</p>	<p>Nesting Height Extension for Direct PV10, PROV10, others BH-7274-073 • 3" Extension (Ref 30500-6200) BH-7274-074 • 6-1/2" Extension (Ref 30500-6201)</p>  <p>Type NS 1.575" (40mm) Extension Height 1"</p>
<p>BH-7548-003 (Ref V12TP-4303) 2" Nesting Style Height Extension</p>  <p>Type NS 1.575" (40mm) 2" 1-1/2"</p>	<p>BH-7548-001 (Ref V12TP-4301) 4-1/2" Nesting Style Height Extension</p>  <p>Type NS 1.575" (40mm) 4-1/2" 1-1/2"</p>	<p>BH-7548-002 (Ref V12TP-4302) 8-1/2" Tall Nesting Style Height Extension</p>  <p>Type NS 1.575" (40mm) 8-1/2" 1-1/2"</p>

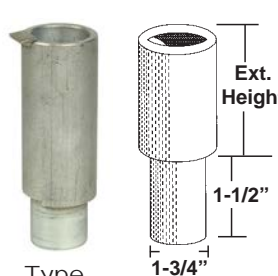
1-3/4" Pin OD For Some Models: Rotary, Nussbaum

<p>Nesting Height Extension 1-3/4" OD Pin x 1-1/2" Long Pin</p> <p>BH-7533-98 3-1/2" Extension (Ref FJ6146)</p> <p>BH-7533-99 5" Extension (Ref FJ6147)</p>  <p>Type NS 1-3/4" Ext. Height 1-1/2"</p>	<p>1-3/4" PIN OD • 1-3/16" LONG PIN Nesting Style Steel Pad Adapter with Round Rubber Pad for Nussbaum (Ref 245SPL28217)</p> <p>BH-7454-10 Adapter with Pad</p>  <p>Replacement Pad: BH-7450-02 1-3/4" 1-3/16"</p>
---	--

Height Extensions and Adapters By Size

Please always confirm dimensions before ordering. Height Extensions and Adapters come in many different styles and dimensions. SVI is well-known as the adapter expert, specializing in top quality standard and custom adapters. SVI is your answer.

2" Pin OD

For Some Models: Benwil, Bishamon Rotary

FOR ROTARY LIFTS
 For Many Models with Round Adapter "RA" and Truck Adapter "TA" Models with Conventional Arms (NOT Trio Arms)

Nesting Style Height Extension
 2" Pin OD • 1-3/4" Pin Length • Extension Height Varies (Listed Below)

BH-7515-67 (Ref FJ6171-1B)	3-1/2" (90mm) Extension Height
BH-7515-66 (Ref FJ6171-2B, FJ6171-2ZN)	5" (130mm) Extension Height
BH-7515-68 (Ref FJ6171-2X)	8" (200mm) Extension Height

BH-7536-90A Height Extension Hanger Bracket for 2" Pin OD
 Holds 4 Adapters (Includes 1 Rack & Hardware)

BH-7536-90 (Ref FJ7880 / FJ7880BK) Height Extension Kit
 (Includes 4 Each 3-1/2" & 5" and Brackets)

Kit includes:
 (4) 5" Nesting Extension
 (4) 3-1/2" Nesting Extension
 (2) Hanger Brackets

Pick Up Adapter Pad Assembly with 2" Collar
 BH-7209-99 (Ref 100946)

1-1/2"-6 Thread
 2" Collar For Benwil
 Replacement Pad: BH-7205

Truck Pick Up Adapter Pad with 2" Collar
 BH-7210-03A (Ref 100945) 1 Adapter Only
 BH-7210-03 (Ref 101005) Kit of 4 Adapters and Hanger Bracket # BH-7210-03B (Ref 300972) For Benwil

Specialty Wide Adapter for 2019, 2020 and newer Chevrolet 1500 Silverado and GM Sierra Trucks 2" Collar Diameter
 Features 7" Wide Lifting Area (Ref 100946x)

BH-7209-99GMT-1 (1) Adapter with 2" Collar & Pad
 BH-7209-99GMT-2 (2) Adapters with 2" Collar & Pad
 BH-7542-75P Replacement Pad Only
 BH-7542-75P-4 Replacement Pads (Set of 4)

TYPE GMT
 7" Wide Lifting Area
 2" Collar Diameter

Height Extensions and Adapters By Size

Please always confirm dimensions before ordering. Height Extensions and Adapters come in many different styles and dimensions. SVI is well-known as the adapter expert, specializing in top quality standard and custom adapters. SVI is your answer.

2-1/8" Pin OD

For Some Models:
Challenger

Complete Pad Assembly
2-1/8" OD Collar
Not Frame Engaging
BH-7232-67 (Ref 12563)



1-3/8"-6
Threads

2-1/8" OD
Collar

Replacement Pad—See BH-7101-00

2-1/4" Pin OD / Nut/Collar OD

For Some Models:
Benwil / Bishamon

3" Nesting Style Height Extension • 2-1/4" Pin OD
BH-7208-66-3

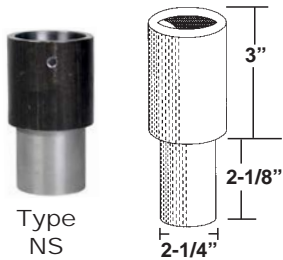

Type
NS

Pick Up Adapter Pad Assembly with 2-1/4" Collar
BH-7208-66B
(Ref 100965, 100967)



Replacement Pad: BH-7205

Truck Pick Up Adapter Pad (1) with 2-1/4" Collar
BH-7207-01 (Ref 101086)



Max Height is
about 9"

(Other Ref 101085, 100958, 100961)

Truck Pick Up Adapter Pad with 2-1/4" Collar

BH-7207-97A (Ref 100963)
1 Adapter Only
BH-7207-97 (Ref 101006)
Kit of 4 Adapters



8.625" Min. Height
14.25" Max. Height

Specialty Wide Adapter for 2019, 2020 and newer Chevrolet 1500 Silverado and GM Sierra Trucks 2-1/4" Collar Diameter
Features 7" Wide Lifting Area (Ref 100965x)

- BH-7208-66GMT-1 (1) Adapter with 2-1/4" Collar & Pad
- BH-7208-66GMT-2 (2) Adapters with 2-1/4" Collar & Pad
- BH-7542-75P Replacement Pad Only
- BH-7542-75P-4 Replacement Pads (Set of 4)



2-1/4" Collar Diameter



Height Extensions and Adapters By Size

Please always confirm dimensions before ordering. Height Extensions and Adapters come in many different styles and dimensions. SVI is well-known as the adapter expert, specializing in top quality standard and custom adapters. SVI is your answer.

2-3/8" Pin OD / 60mm Pin OD Pin Length Varies

For Some Models: BendPak, Challenger, Others



Height Extension Kit for Challenger CL9/CL10

Pin Diameter 2-3/8" • Pin Length 1-1/2"

BH-7234-119 (Ref 10315) KIT COMES WITH:
 3" Tall Height Extension - Qty (4)
 6" Tall Height Extension - Qty (2)
 Qty (2) Hanging Brackets With Hardware

SVI Part #	OEM #	Pin Diameter	Pin Length	Description
BH-7234-119	10315	2-3/8"	1-1/2"	Height Extension Kit
BH-7234-119A	B2206-3	2-3/8"	1-1/2"	3" Height Extension
BH-7234-119B	B2206-6	2-3/8"	1-1/2"	6" Height Extension
BH-7234-119C	B2209			Hanging Bracket
<i>Included with Kit</i>				Pan Head Screws

Type NS

BH-7232-98 (Ref B2260 / B2250)
 Drop-In Adapter /
 Foot Pad Assembly
 with Round Rubber Pad

*Works well with
 BH-7234-119 (ref 10315)
 Height Extension Kit*



5-7/16" OD Pad
 1-2/5" Pin Length
 2.358" Pin Diameter

Replacement Pad: BH-7232-93

BH-7232-01UPB (Ref B2270)
 Drop-In Adapter /
 Foot Pad Assembly
 with Urethane Pad

*Works well with
 BH-7234-119 (ref 10315)
 Height Extension Kit*



Top • 4-1/8" ID
 1-2/5" Pin Length
 2.358" Pin Diameter

Replacement Pad: BH-7232-01U (Ref A1104H, Urethane) or BH-7232-01OHD (Rubber)

Complete Pad Assembly
 2.359" OD (60 mm) Collar
 Not Frame Engaging

BH-7234-120 (Ref B12062-12)



2"-4 Threads
 2.359" OD Collar

Replacement Pad—See BH-7101-00

Complete Pad Assembly
 2.359" OD (60mm) Collar
 Frame Engaging

BH-7234-128 (Ref B12162S-12)



2-4-1/2 UNC-2A Threads
 2.359" OD Collar

Replacement Pad—See BH-7232-01U

7" Nesting Height Extension
 2-3/8" (60 mm) Diameter Pin

BH-7234-119D (Ref B2206-7)

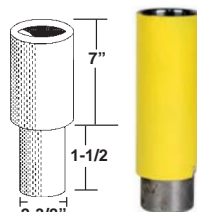

7"
 1-1/2"
 2-3/8"

Type NS



Height Extensions and Adapters By Size

Please always confirm dimensions before ordering. Height Extensions and Adapters come in many different styles and dimensions. SVI is well-known as the adapter expert, specializing in top quality standard and custom adapters. SVI is your answer.

2-3/8" Pin OD / 60mm Pin OD Pin Length Varies

For Some Models: BendPak, Challenger, Others



Type NS
Nesting Style
Height Extensions
for BendPak
2-3/8" (60mm) Diameter Pin

2" Nesting Height Extension
2-3/8" (60 mm) Diameter Pin
(Ref 5215757)
BH-7474-84 (1) Adapter
BH-7474-84-4 (4) Adapters



2-3/4" Nesting Height Extension
2-3/8" (60 mm) Diameter Pin
(Ref 5215758, 5746192)
BH-7474-85 (1) Adapter
BH-7474-85-4 (4) Adapters

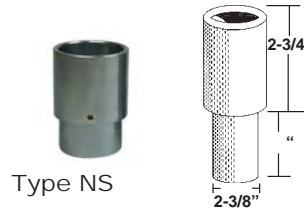

4-7/8" Nesting Height Extension
2-3/8" (60 mm) Diameter Pin
(Ref 5215759, 5746193)
BH-7474-86 (1) Adapter
BH-7474-86-4 (4) Adapters



Round Lift Pad Adapter with 2-3/8" (60 mm) Pin (Ref 5215760)

BH-7474-83-4 (4) Adapters with 60mm Pin & Pad Kit

BH-7474-83 (1) Adapter with 60mm Pin & Pad

BH-7474-78 Replacement Pad Only



Type NSP

Telescopic / Spin-Up Round Lift Pad Adapter 60 mm

Gives an extra 3" height clearance on 9,000 and 10,000 Lb Lifts (not for use on lifts with low profile arms)

Individual Adapter
BH-7474-79TP (Ref 5215704)

Set of 4 Adapters
BH-7474-79TP-4 (Ref 5215762)



Replacement Slip-Over Pad: BH-7474-78

Specialty Wide Adapter for 2019, 2020 and newer Chevrolet 1500 Silverado and GM Sierra Trucks - 2-3/8" (60 mm) Pin Dia.
Features 7" Wide Lifting Area

BH-7479-349GMT-1 (1) Adapter with 60mm Pin & Pad

BH-7479-349GMT-2 (2) Adapters with 60mm Pin & Pad

BH-7542-75P Replacement Pad Only

BH-7542-75P-4 Replacement Pads (Set of 4)



2-3/8" (60 mm) Pin Dia.



2.359" Pin Diameter

Frame Engaging Adapters for Challenger
2.359" OD Pin

BH-7234-121A (Ref B2201) 1 Adapter

BH-7234-125 (Ref 10314) Set of 2

BH-7234-121 (Ref 10318) Set of 4

BH-7234-121K (Ref 10319) KIT - Set of 4 Adapters, Hangers, and Height Extensions

NOTE: Confirm Pin OD before ordering.



Frame Engaging Adapter Kit for Challenger Lifts

(Ref 10319, 10318, B2201, 10314)

2.359" OD Pin

BH-7234-121K (Ref 10319)

Kit Includes Set of 4 Adapters, (2) Tall and (4) Short Height Extensions, (2) Extension Holders

NOTE: Confirm Pin OD before ordering.

2.359" Pin Diameter



Height Extensions and Adapters By Size

Please always confirm dimensions before ordering. Height Extensions and Adapters come in many different styles and dimensions. SVI is well-known as the adapter expert, specializing in top quality standard and custom adapters. SVI is your answer.

2-7/16" Pin OD Pin Length Varies

For Some Models: Benwil / Bishamon

Steel Support & Adjustable Nut Adapter Pad Assembly with 2-7/16" Collar with Lip on Top / 1-1/2"-4 Acme Screw
 BH-7205-02 (Ref 00102500, LAE000000)

Kit Assembly Includes:

- BH-7205-02B (ref 00102500) Steel Support
- BH-7205-04 (ref 11319950) Adjust Nut
- BH-7205 Rubber Arm Pad
- Pad Fasteners
- Roll Pin



Replacement Pad: BH-7205
 or Pad Kit: BH-7205-4

Looking for a custom adapter with anti-slip sides on the pad, contact SVI!

Adjustable Truck Pick Up Adapter 7-1/2" to 11.5"
 2-7/16" Collar

BH-7201-81 (Ref TA-7)
 Truck Height Extension Adapter
 No Pad Style



BH-7201-81
 Pictured

BH-7201-81P (Ref TA-7P)
 Truck Height Extension Adapter
 with BH-7205 Pad Rectangle Top

Specialty Wide Adapter for 2019, 2020 and newer Chevrolet 1500 Silverado and GM Sierra Trucks 2-7/16" Collar Diameter
 Features 7" Wide Lifting Area (Ref 100946x)

- BH-7205-02GMT (1) Adapter with 2-7/16" Collar & Pad
 - BH-7205-02GMT-2 (2) Adapters with 2-7/16" Collar & Pad
- Features BH-7542-75P Rectangle Rubber Pad



1-1/2"-4 Screw
 with 2-7/16" Collar



Height Extensions and Adapters By Size

Please always confirm dimensions before ordering. Height Extensions and Adapters come in many different styles and dimensions. SVI is well-known as the adapter expert, specializing in top quality standard and custom adapters. SVI is your answer.

2-3/4" Pin OD Pin Length Varies

For Some Models: Rotary





<p>BH-7536-52 (Ref FJ7822-3) Height Extension Holder Rack</p> 	<p>BH-7536-53A 4" Nesting Height Extension Aluminum</p> 	<p>BH-7536-53 (Ref FJ7822-4) 5" Nesting Height Extension Aluminum</p> 	<p>BH-7536-53B 6" Nesting Height Extension Aluminum</p> 
<p>BH-7536-55 (Ref FJ7822-6) 7-1/2" Nesting Height Extension Aluminum</p> 	<p>BH-7536-54 (Ref FJ7822-5) 10" Nesting Height Extension Aluminum</p> 	<p>5" Nesting Style Height Extension BH-7548-028 (Ref FJ71013)</p> 	<p>10" Nesting Style Height Extension BH-7548-029 (Ref FJ71014)</p> 
<p>Specialty Wide Adapter for 2019, 2020 and newer Chevrolet 1500 Silverado and GM Sierra Trucks - 2-3/4" Collar / Nut OD <i>Features 7" Wide Lifting Area • (Ref FJ7822-1x)</i></p> <p>BH-7536-50GMT (2) Adapters with 2-3/4" Collar & Pad BH-7536-50GMT-1 (1) Adapter with 2-3/4" Collar & Pad BH-7542-75P Replacement Pad Only BH-7542-75P-4 Replacement Pad Kit (4)</p>  <p>TYPE GMT 7" Wide Lifting Area</p> <p>2-3/4" OD Collar</p>		<p>BH-7536-50 (Ref FJ7822-1) Swing Arm Adapter Assembly</p>  <p>2-3/4"</p>	<p>BH-7536-51 (Ref FJ7822-2, FJ7822-2YL) Rubber Adapter Pad</p> 
<p>BH-9791-42 (Ref FD2339) 5" Nesting Style Height Extension - Aluminum</p> 	<p>BH-9791-43 (Ref FD2338) 8" Nesting Style Height Extension - Aluminum</p> 		

Height Extensions and Adapters By Size

Please always confirm dimensions before ordering. Height Extensions and Adapters come in many different styles and dimensions. SVI is well-known as the adapter expert, specializing in top quality standard and custom adapters. SVI is your answer.

3-1/8" Pin OD Pin Length Varies

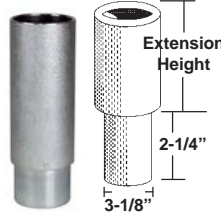
For Some Models: Challenger

<p>Complete Screw-Up Pad Adapter Assembly <i>Not Frame Engaging</i></p> <p>BH-7234-208 (Ref B12062, 12062-12)</p>  <p>1-3/4"-5 UNC Threads 3-1/8" OD Collar</p> <p><i>Replacement Pad—See BH-7101-00</i></p>	<p>Complete Screw-Up Pad Adapter Assembly <i>Frame Engaging</i></p> <p>BH-7234-128-15 (Ref B12162S)</p>  <p>2"-4-1/2 UNC Threads 3-1/8" OD Collar</p> <p><i>Replacement Pad—See BH-7232-01U</i></p>	<p>Nesting Height Extensions 3-1/8" Diameter Pin</p> <p>BH-7234-210 (Ref B12069, 12069) 4" Extension BH-7234-208-5 (Ref 12062-12x) 5" Extension BH-7234-208-6 (Ref 12062-12x) 6" Extension BH-7234-211 (Ref 12068) 8" Extension</p> <p>ALSO AVAILABLE BH-7234-211H (Ref 12071) Extension Holder Rack</p>  <p>3-1/8" Pin Diameter Type NS</p>
<p>Specialty Wide Adapter for 2019, 2020 and newer Chevrolet 1500 Silverado and GM Sierra Trucks - Screw Up Adapter <i>Features 7" Wide Lifting Area • SVI Exclusive</i></p> <p>BH-7234-208GMT 12062-12x (1) Adapter with Pad BH-7542-75P Replacement Pad Only BH-7542-75P-4 Replacement Pads (Set of 4)</p>  <p>2"-4-1/2 UNC Threads 3-1/8" OD Collar</p>		



Height Extensions and Adapters By Size

Please always confirm dimensions before ordering. Height Extensions and Adapters come in many different styles and dimensions. SVI is well-known as the adapter expert, specializing in top quality standard and custom adapters. SVI is your answer.

Featuring 1"-8 Threads

For Some Models: Western

4" Screw Up Height Extension with 4" x 4.5" Rectangle Slip On Pad



BH-7090-79
(Replaces Ref S-351)

1"-8 Threads

Type SURX



Replaceable Pad: BH-7750-02

Featuring 1-1/8"-7 Threads

Spin-Up Height Extension with Octagon Rubber Pad
Features Replaceable Rubber Pad BH-7235-90A

BH-7091-17 • 4" Adapter • 5" Top



Type SUH5
Threads 1-1/8"-7

Replacement Rubber Pad: BH-7235-90A / BH-7235-90 (Kit) or Heavy Duty Version BH-7235-90AX / BH-7235-90K (Kit)

Screw Up Height Extension for Close to Frame Obstructions

1-1/8"-7 Threads
Features BH-9755-50-1 Rubber Pad

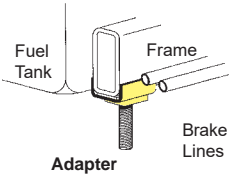

Commonly sold for use on the rear of late model trucks. Avoids denting or puncturing fuel tank and smashing brake lines.

SVI Part #	Height	Threads
BH-7091-48	4"	1-1/8"
BH-7091-49	6"	1-1/8"

Type SUNRW

Height Extensions and Adapters By Size

Please always confirm dimensions before ordering. Height Extensions and Adapters come in many different styles and dimensions. SVI is well-known as the adapter expert, specializing in top quality standard and custom adapters. SVI is your answer.

Featuring 1-1/4"-7 Threads

For Some Models:
HydraLift, Globe / Ford Smith, Snap-On, Wheeltronic

BH-7287-02 (Ref 28191)
Low Profile Adapter for Hydra-Lift
(Does not use a pad.)

Top:
4.5" x 5"

1-1/4"-7
Threads

BH-7287-59 (Ref 30)
Optional High Lift Adapter for Hydra-Lift
(Does not use a pad.)

Top:
4.5" x 5"

1-1/4"-7
Threads

Conversion Pad Assembly 1-1/4"-7 Screw
Features Octagon Pad BH-7225-01
Slip-Over Extensions Available!

6" Square Top with
Corners Turned Up

Type
SUH6

SVI Part #	Ref #	Description
BH-7090-20		Screw-Up Adapter 1-1/4"-7 Height 4"
BH-7090-21		Screw-Up Adapter 1-1/4"-7 Height 5"
BH-7090-22		Screw-Up Adapter 1-1/4"-7 Height 6"
BH-7090-23		Screw-Up Adapter 1-1/4"-7 Height 7"
BH-7090-24		Screw-Up Adapter 1-1/4"-7 Height 8"
BH-7227-41		Screw-Up Adapter 1-1/4"-7 Height 10"
BH-7227-42		Screw-Up Adapter 1-1/4"-7 Height 12"

Spin-Up Height Extension with Octagon Rubber Pad
Features Replaceable Rubber Pad BH-7235-90A
Slip-Over Height Extensions Available, too! Ask SVI!

5" Top

Type
SUH5

Threads
1-1/4"-7

BH-7091-22 • 4" Adapter
BH-7091-23 • 5" Adapter
BH-7091-24 • 6" Adapter
BH-7091-25 • 7" Adapter
BH-7091-26 • 8" Adapter

Replacement Rubber Pad: BH-7235-90A / BH-7235-90 (Kit)
or Heavy Duty Version BH-7235-90AX / BH-7235-90K (Kit)

Screw Up Height Extension with 4-15/16" Bolt On Round Pad
1-1/4"-7 Threads
Features BH-7450-02 Rubber Pad
Slip-Over Height Extensions Available, too! Ask SVI!

Type
SUR5

BH-7090-60 • 4" Adapter
BH-7090-61 • 5" Adapter
BH-7090-62 • 6" Adapter
BH-7090-63 • 7" Adapter
BH-7090-64 • 8" Adapter

Features Replaceable Rubber Pad BH-7450-02

Screw Up Height Extension with 4" x 4.5" Rectangle Slip On Pad
1-1/4"-7 Threads
Replaces Ref 3-0170 (BH-7090-80)

Type
SURX

BH-7090-80 • 4" Adapter
BH-7090-81 • 5" Adapter
BH-7090-82 • 6" Adapter
BH-7090-83 • 7" Adapter
BH-7090-84 • 8" Adapter

Features BH-7750-02 Replaceable Rubber Pad

Screw Up Adapter with Pad

BH-7090-40 • 4" Adapter
BH-7090-41 • 5" Adapter
BH-7090-42 • 6" Adapter
BH-7090-43 • 7" Adapter
BH-7090-44 • 8" Adapter

Round Pad
Diameter:
6-5/16"

1-1/4"-7
Threads

Type
SUR6

Replacement Pad: BH-7150-02

Screw Up Height Extension for Close to Frame Obstructions
1-1/4"-7 Threads
Features BH-9755-50-1 Rubber Pad

Commonly sold for use on the rear of late model trucks. Avoids denting or puncturing fuel tank and smashing brake lines.

Type
SUNRW

BH-7091-45 • 4" Adapter
BH-7091-46 • 6" Adapter
BH-7091-47 • 8" Adapter

Screw Adapter with Slip-Over Square Pad for Globe / Ford Smith
BH-7250-03 (Ref FS-207526, 207526, 203556, FS-203556)

Type
SUH6

1-1/4"-7
Threads

BH-7250-03P
Pad Dimensions
4-1/2" x 4-1/2"

Replacement Pad—See BH-7250-03P



Height Extensions and Adapters By Size

Please always confirm dimensions before ordering. Height Extensions and Adapters come in many different styles and dimensions. SVI is well-known as the adapter expert, specializing in top quality standard and custom adapters. SVI is your answer.

Featuring 1-3/8" -4 Acme Threads

For Some Models:
Benwil / Bishamon, Gilbarco

Steel Support Original Version
for TP-7, TPO-7, TP-55, TPO-55
Fits Original Arm Only •
Threads 1-3/8" -4 Acme
BH-7205-020V (Ref 205176)



For Benwil
Replacement Pad:
BH-7205
or Pad Kit: BH-7205-4

Conversion Pad Assembly
Features Octagon Pad
BH-7090-32 • 4" Adapter
BH-7090-33 • 5" Adapter
BH-7090-34 • 6" Adapter
BH-7090-35 • 7" Adapter
BH-7090-36 • 8" Adapter

1-3/8" -4 Acme
Screw Threads
Type SUH6



Replacement Pad: BH-7225-01

Screw Up Adapter
with 4-15/16" OD Round Pad
BH-7090-72 • 4" Adapter
BH-7090-73 • 5" Adapter

Round Pad Diameter: 4-15/16"

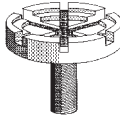

1-3/8" -4
ACME
Threads
Type SUR5
Replacement Pad: BH-7450-02

Screw Up Adapter
with 6-5/16" OD Round Pad
BH-7090-52 • 4" Adapter
BH-7090-53 • 5" Adapter

Round Pad Diameter: 6-5/16"



1-3/8" -4
ACME
Threads
Type SUR6
Replacement Pad: BH-7150-02

Pick Up Pad Support
Adapter for Gilbarco
ATF-55, ATF-70, ATF-70B
BH-7352-02
(Ref R18220-51)



For Gilbarco
1-3/8" -4 Acme
Threads

Screw Up Height Extension for Close to Frame Obstructions
1-3/8" -4 Acme Threads
Features BH-9755-50-1 Rubber Pad
Commonly sold for use on the rear of late model trucks. Avoids denting or puncturing fuel tank and smashing brake lines.

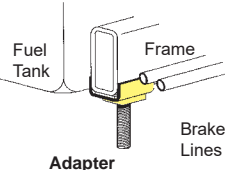

Fuel Tank
Frame
Adapter
Brake Lines
Type SUNRW

SVI Part #	Height	Threads
BH-7091-41	4"	1-3/8" -4
BH-7091-42	6"	1-3/8" -4
BH-7091-43	8"	1-3/8" -4
BH-7091-44	10"	1-3/8" -4

Height Extensions and Adapters By Size

Please always confirm dimensions before ordering. Height Extensions and Adapters come in many different styles and dimensions. SVI is well-known as the adapter expert, specializing in top quality standard and custom adapters. SVI is your answer.

Featuring 1-3/8"-6 Threads

For Some Models:
ALM, Ammco®, Challenger, Others

Specialty Wide Adapter for 2019, 2020 and newer Chevrolet 1500 Silverado and GM Sierra Trucks 1-3/8"-6
Features 7" Wide Lifting Area • SVI Exclusive

BH-7232-17GMT-1 (1) Screw Up Adapter with Pad
BH-7232-17GMT (2) Screw Up Adapters with Pad
BH-7542-75P Replacement Pad Only
BH-7542-75P-4 Replacement Pads (Set of 4)

TYPE GMT
7" Wide Lifting Area

1-3/8"-6 Screw

Conversion Pad Adapter Assembly
Features Octagon Pad BH-7225-01
1-3/8"-6 Screw

Available in Various Heights

Type SUH6

SVI Part #	Ref #	Description
BH-7225-03	31133	Screw-Up Adapter 1-3/8"-6 Height 3-1/2" 4B31133, 4B100066
BH-7090-25*		Screw-Up Adapter 1-3/8"-6 Height 4"
BH-7090-26*		Screw-Up Adapter 1-3/8"-6 Height 5"
BH-7090-27*		Screw-Up Adapter 1-3/8"-6 Height 6"
BH-7090-28*		Screw-Up Adapter 1-3/8"-6 Height 7"
BH-7225-04	10062 / 200083	Screw-Up Adapter 1-3/8"-6 Height 8"
BH-7090-30*		Screw-Up Adapter 1-3/8"-6 Height 9"
BH-7090-31*		Screw-Up Adapter 1-3/8"-6 Height 10"

Screw Up Height Extension with 3-7/8" x 5" Rectangle Top
1-3/8"-6 Threads
Features BH-7101-00 Rubber Pad

BH-7091-86 • 4" Adapter
BH-7091-87 • 5" Adapter
BH-7091-88 • 6" Adapter
BH-7091-89 • 7" Adapter
BH-7091-90 • 8" Adapter

Type - SUH
3-7/8" x 5"

Spin-Up Height Extension with Octagon Rubber Pad
Features Replaceable Rubber Pad BH-7235-90A

BH-7091-27 • 4" Adapter
BH-7091-28 • 5" Adapter
BH-7091-29 • 6" Adapter
BH-7091-30 • 7" Adapter
BH-7091-31 • 8" Adapter

Type SUH5
Threads 1-3/8"-6

Replacement Rubber Pad: BH-7235-90A / BH-7235-90 (Kit) or Heavy Duty Version BH-7235-90AX / BH-7235-90K (Kit)

Screw Up Height Extension for Close to Frame Obstructions
1-3/8"-6 Threads
Features BH-9755-50-1 Rubber Pad

Commonly sold for use on the rear of late model trucks. Avoids denting or puncturing fuel tank and smashing brake lines.

BH-7091-37 • 4" Adapter
BH-7091-38 • 6" Adapter
BH-7091-39 • 8" Adapter
BH-7091-40 • 10" Adapter

Type SUNRW

Spin-Up Height Extension with Octagon Rubber Pad
Features Replaceable Rubber Pad BH-7235-90A

BH-7091-32 • 4" Adapter
BH-7091-33 • 5" Adapter
BH-7091-34 • 6" Adapter
BH-7091-35 • 7" Adapter
BH-7091-36 • 8" Adapter

Type SUH5
Threads 1-3/8"-6

Replacement Rubber Pad: BH-7235-90A / BH-7235-90 (Kit) or Heavy Duty Version BH-7235-90AX / BH-7235-90K (Kit)



Height Extensions and Adapters By Size

Please always confirm dimensions before ordering. Height Extensions and Adapters come in many different styles and dimensions. SVI is well-known as the adapter expert, specializing in top quality standard and custom adapters. SVI is your answer.

Featuring 1-3/8" -6 Threads

For Some Models:
ALM, Ammco®, Challenger, Others

Screw Up Height Extension with 4-15/16" Bolt On Round Pad
1-3/8"-6 Threads
Features BH-7450-02 Rubber Pad

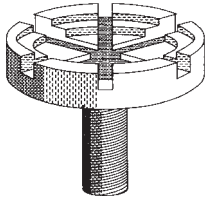

Type
SUR5

- BH-7090-65 • 4" Adapter
- BH-7090-66 • 5" Adapter
- BH-7090-67 • 6" Adapter
- BH-7090-68 • 7" Adapter
- BH-7090-69 • 8" Adapter
- BH-7090-70 • 9" Adapter
- BH-7090-71 • 10" Adapter

Screw Up Adapter with Round Pad
Features Replaceable Rubber Pad BH-7150-02

- BH-7090-45 • 4" Adapter
- BH-7090-46 • 5" Adapter
- BH-7090-47 • 6" Adapter**
- BH-7090-48 • 7" Adapter
- BH-7090-49 • 8" Adapter
- BH-7090-50 • 9" Adapter**
- BH-7090-51 • 10" Adapter

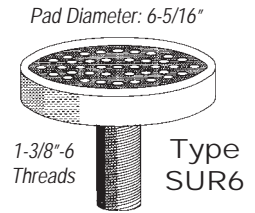

1-3/8"-6
Threads Type
SUR6

Includes Replaceable Pad—See BH-7150-02

Screw Up Height Extension with 4" x 4.5" Rectangle Slip On Pad
1-3/8"-6 Threads
Features BH-7750-02 Rubber Pad

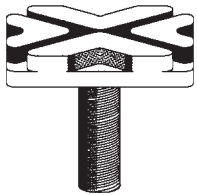

Type
SURX

- BH-7090-85 • 4" Adapter
- BH-7090-86 • 5" Adapter
- BH-7090-87 • 6" Adapter
- BH-7090-88 • 7" Adapter
- BH-7090-89 • 8" Adapter



BH-7150-93 (Ref 15-4027A)
10" Height Extension
1-3/8"-6 Threads

Please Confirm Threads

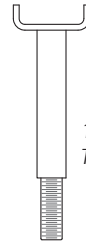

1-3/8"-6
Threads

BH-7225-03-DP
3-1/2" Screw-Up Adapter with
4" x 4" Diamond Plate Top
1-3/8"-6 Threads

Please Confirm Threads

1-3/8"-6
Threads



Height Extensions and Adapters By Size

Please always confirm dimensions before ordering. Height Extensions and Adapters come in many different styles and dimensions. SVI is well-known as the adapter expert, specializing in top quality standard and custom adapters. SVI is your answer.

Featuring 1-1/2"-6 Threads

Screw Up Adapter with Round Pad

BH-7090-56 • 3" Adapter
 BH-7090-57 • 5" Adapter
 BH-7090-58 • 8" Adapter

Pad Diameter: 6-5/16"

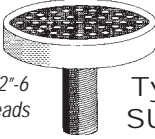

1-1/2"-6 Threads Type SUR6

Replacement Pad: BH-7150-02

Spin-Up Height Extension with Octagon Rubber Pad
 Features Replaceable Rubber Pad BH-7235-90A

BH-7091-80 • 5" Adapter
 BH-7091-81 • 6" Adapter
 BH-7091-82 • 7" Adapter
 BH-7091-83 • 8" Adapter
 BH-7091-84 • 9" Adapter
 BH-7091-85 • 10" Adapter

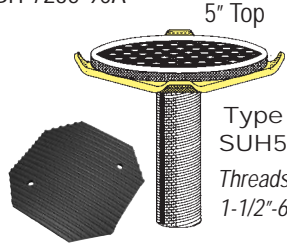

5" Top
 Type SUH5
 Threads 1-1/2"-6

Replacement Rubber Pad: BH-7235-90A / BH-7235-90 (Kit)
 or Heavy Duty Version BH-7235-90AX / BH-7235-90K (Kit)

Featuring 1-3/4"-5 Threads

For Some Models:
 Challenger, Forward Lifts, Others

4" Spin Up Height Extension
 BH-7237-90 (Ref 137603-1) Individual (1) Adapter
 BH-7237-89 (Ref 137603) Set of 4 Adapters

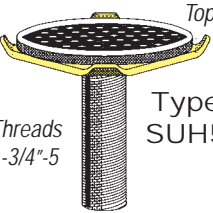

Top 5.5"
 Threads 1-3/4"-5 Type SUH5

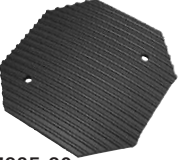

Replacement Rubber Pad: BH-7235-90A / BH-7235-90,
 or Heavy Duty Version BH-7235-90AX / BH-7235-90K

1-3/4"-5" THREADS • SCREW-UP ADAPTER AND PAD

Specialty Wide Adapter for 2019, 2020 and newer Chevrolet 1500 Silverado and GM Sierra Trucks
 Features 7" Wide Lifting Area • SVI Exclusive

BH-7237-95GMT 5" Adapter Base and Pad (Set of 2)
 BH-7237-95GMT-1 5" Adapter Base and Pad (1)

BH-7237-99GMT 9" Adapter Base and Pad (Set of 2)
 BH-7237-99GMT-1 9" Adapter Base and Pad (1)

Features BH-7542-75P Rectangle Rubber Pad

FOR DPO15



1-3/4"-5 Threads

BH-7237-95GMT
 BH-7237-95GMT-1



1-3/4"-5 Threads

BH-7237-99GMT
 BH-7237-99GMT-1

TYPE GMT

7" Wide Lifting Area



Height Extensions and Adapters By Size

Please always confirm dimensions before ordering. Height Extensions and Adapters come in many different styles and dimensions. SVI is well-known as the adapter expert, specializing in top quality standard and custom adapters. SVI is your answer.

Featuring 2"-4.5 UNC 2A Threads

For Some Models: ALM

BH-7150-97 (Ref 15-4031A)

Arm Adapter - Standard

Please Confirm Threads



Also see BH-7150-97FRP

BH-7150-97FRP (Ref 15-4031Ax)

**Flat Adapter Assembly
with Rubber Pad
For ALM 15,000 Lb Lift**

Please Confirm Threads



**Features Rectangle
Rubber Pad BH-7101-00**

*With Rectangle Pad
3-7/8" x 5" Top*



Height Extensions and Adapters By Size

Please always confirm dimensions before ordering. Height Extensions and Adapters come in many different styles and dimensions. SVI is well-known as the adapter expert, specializing in top quality standard and custom adapters. SVI is your answer.

Slip-On Style—Opening Dimensions: 3-3/8" x 1-5/16"

For Some Models:
Globe

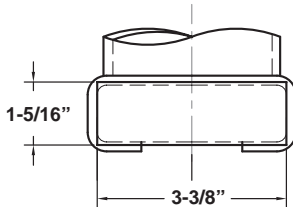

Adapter Base Inside Dimensions
Shape may vary depending on height extension.

Adjustable Height Extension With Rectangle Pad

BH-7253-23
4"–6" Adjustable

BH-7253-24
6"–9-1/2" Adjustable

Type
AHDR

Opening
Dimensions:
3-3/8" x 1-5/16"

Replacement Pad—See BH-7205

Slip-On Height Extension LDR Style

BH-7253-10 3" Extension
 BH-7253-11 4" Extension
 BH-7253-12 5" Extension
 BH-7253-13 6" Extension
 BH-7253-14 7" Extension

Type
LDR

Opening
Dimensions:
3-3/8" x 1-5/16"

Replacement Pad: BH-7205

Slip-On Height Extension with Rectangle Pad

BH-7253-15 3" Extension
 BH-7253-16 4" Extension
 BH-7253-17 5" Extension
 BH-7250-05 6" Extension
 BH-7253-19 7" Extension
 BH-7253-20 8" Extension
 BH-7253-21 9" Extension
 BH-7253-22 10" Extension

Type
HDR

Opening Dimensions:
3-3/8" x 1-5/16"

Replacement Pad: BH-7205



Height Extensions and Adapters By Size

Please always confirm dimensions before ordering. Height Extensions and Adapters come in many different styles and dimensions. SVI is well-known as the adapter expert, specializing in top quality standard and custom adapters. SVI is your answer.

Slip-On Style—Opening Dimensions: 3-3/4" x 1-1/4"

These Slip-On Adapters Fit Over Spin-Up Adapters with BH-7205 (Ref 100533) Rectangle Rubber Pad

For Some Models:
Benwil
Bishamon

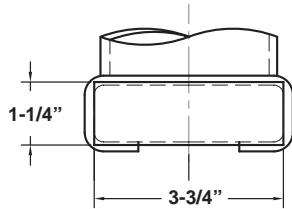

Adapter Base Inside Dimensions
Shape may vary depending on height extension.

Fits Over
BH-7205 ▶



Available in Different
Threads / Collars.

Rubber Arm Pad (1)
BH-7205 (Ref 100533)

Rubber Arm Pad Kit of 4 Pads
Kit Includes Fasteners
BH-7205-4 (Ref 100533)



4-3/8" x 3-1/2"

Slip-On Height Extension with Rectangle Pad

Fits over BH-7205 Rectangle Pad on Spin-Up

- BH-7202-55 3" Extension
- BH-7202-56 4" Extension
- BH-7200-12 6" Extension (Ref 100987)
- BH-7202-58 7" Extension
- BH-7202-59 8" Extension
- BH-7200-12L 9" Extension

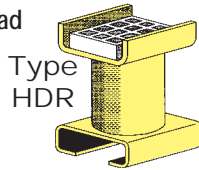

Type
HDR

Opening
Dimensions:
3-3/4" x 1-1/4"

(Not for square pads)

Replacement Pad: BH-7205

Slip-On Adjustable Height Extension AHDR Style

- BH-7202-63 4" to 6"
- BH-7202-64 6" to 9-1/2"

*Fits over BH-7205
Rectangle Pads on
Spin Up Adapter*

Opening Dimensions:
3-3/4" x 1-1/4"



Slip-On Height Extension BH-7202-50 3" Extension BH-7202-53 6" Extension

*Fits over BH-7205 Rectangle Pad
on Spin-Up*

Type
LDR

Opening
Dimensions:
3-3/4" x 1-1/4"

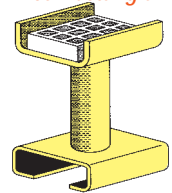

Replacement Pad: BH-7205

Adjustable Height Extension for Close to Frame Obstructions BH-7202-69 6" to 9"

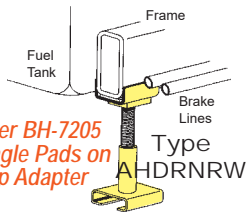

*Fits over BH-7205
Rectangle Pads on
Spin Up Adapter*

Opening Dimensions: 3-3/4" x 1-1/4"
Replacement Pad: BH-9755-50-1

Specialty Arm Receiver and Wide Adapter for Lifting 2019, 2020 and newer Chevrolet 1500 Silverado and GM Sierra Trucks Features 7" Wide Lifting Area

- BH-7200-99 (1) Arm Receiver Only—Use with BH-7542-74
- BH-7542-74 (1) Adapters with Pad—Use with BH-7200-99
- BH-7542-75P Replacement Pad Only
- BH-7542-75P-4 Replacement Pads (Set of 4)



TYPE
GMT
7" Wide
Lifting Area



BH-7542-74
Sold Separately

Arm Receiver
BH-7200-99



Height Extensions and Adapters By Size

Please always confirm dimensions before ordering. Height Extensions and Adapters come in many different styles and dimensions. SVI is well-known as the adapter expert, specializing in top quality standard and custom adapters. SVI is your answer.

Slip-On Style—Opening Dimensions: 4-1/8" x 3/4"

These Slip-On Adapters Fit Over Spin-Up with 4 Corners Turned Up and Rectangular Pad BH-7165-02

For Some Models:
Alamo
ASSSA

BH-7165-10
4"–6" Adjustable Height
Extension with Octagon Pad
Fits over BH-7165-02 Pad

Type
ALDH

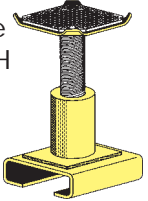

Opening
Dimensions:
4-1/8" x 3/4"

Replacement Pad—See BH-7235-90A

BH-7165-11
6"–9-1/2" Adjustable Height
Extension with Octagon Pad
Fits over BH-7165-02 Pad

Type
ALDH

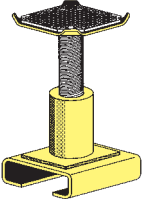

Opening
Dimensions:
4-1/8" x 3/4"

Replacement Pad—See BH-7235-90A



Height Extensions and Adapters By Size

Please always confirm dimensions before ordering. Height Extensions and Adapters come in many different styles and dimensions. SVI is well-known as the adapter expert, specializing in top quality standard and custom adapters. SVI is your answer.

Slip-On Style—Opening Dimensions: 4-3/16" x 13/16"

For Some Models:
Challenger

These Slip-On Adapters Fit Over BH-7232-17HDA-P Style Spin-Up Adapters with BH-7232-01 Square Rubber Pad

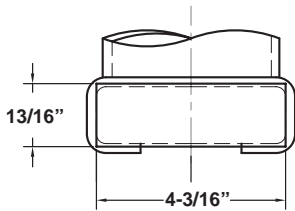

Fits Over
BH-7232-17HDA-P ▶

Adapter Base Inside Dimensions
Shape may vary depending on height extension.

Heavy Duty Screw Up Adapter Base & Pad

Features Replaceable Rubber Pad BH-7232-01

SVI Exclusive: Heavy duty adapter base with increased plate thickness and additional welding process.

Alternative for OE Style A1100, A1101, (B1100 is metric)



SVI Part #

BH-7232-17HDA-P	Heavy Duty Screw Up Adapter with Pad
BH-7232-17HDA	Heavy Duty Screw Up Adapter Base Only
BH-7232-17L	Longer Truck Adapter CL9
BH-7232-17L-4	Longer Truck Adapter CL9 Set of 4

Slip-On Height Extension with Square Pad

Fits over BH-7232-17HDA-P

Features Rubber Pad BH-7232-01

SVI Part #	Ref #	Height	Details
BH-7231-96		3"	Fixed
BH-7232-00	A1105-06	6"	Fixed
BH-7231-99	A1105-10	10"	Fixed
BH-7231-97		4"-6"	Adjustable
BH-7231-98		6"-9-1/2"	Adjustable

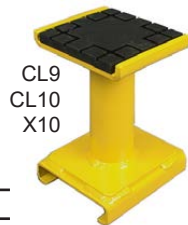

Choose Fixed or Adjustable



*Opening Dimensions:
4-3/16" x 13/16"*



Height Extensions and Adapters By Size

Please always confirm dimensions before ordering. Height Extensions and Adapters come in many different styles and dimensions. SVI is well-known as the adapter expert, specializing in top quality standard and custom adapters. SVI is your answer.

Slip-On Style—Opening Dimensions: 4-3/16" x 1-1/8"

These Slip-On Adapters Fit Over SURX Style Spin-Up Adapters with BH-7750-02 X-Pattern Rectangle Rubber Pad

For Some Models:
Western

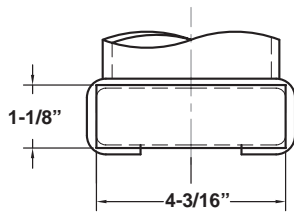

Adapter Base Inside Dimensions
Shape may vary depending on height extension.

Pad Dimensions: 4-1/2" x 4" x 1"

Fits Over
SURX ▶

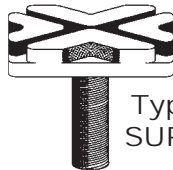

Type
SURX

Available in Different Threads.
See Below

X-Pattern Slip-Over Rectangle Rubber Pad (Ref S-350)

BH-7750-02 1 Pad

Sold Individually

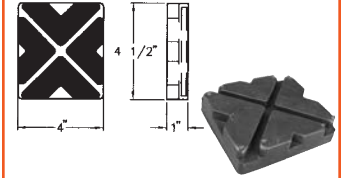

4-1/2" x 4" x 1"

Bottom Side Recessed ID 3.5" x 3/8"

- Slip-On Height Extension**
 BH-7749-97 3" Extension
 BH-7749-98 4" Extension
 BH-7749-99 5" Extension
 BH-7750-01 6" Extension
 BH-7750-09 7" Extension

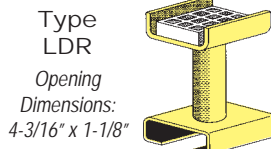

Type
LDR

Opening
Dimensions:
4-3/16" x 1-1/8"

Replacement Pad: BH-7205

- Slip-On Height Extension**
 BH-7749-93 3" Extension
 BH-7749-94 4" Extension
 BH-7749-95 5" Extension
 BH-7749-96 6" Extension

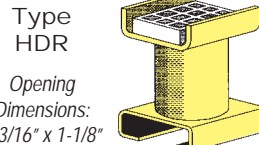

Type
HDR

Opening
Dimensions:
4-3/16" x 1-1/8"

Replacement Pad: BH-7205

- Slip-On Adjustable Height Extension AHDR Style**
 BH-7749-91 4" to 6"
 BH-7749-92 6" to 9-1/2"

Fits over Spin-Up
with X Pattern Pad
BH-7750-02

Opening Dimensions:
4-3/16" x 1-1/8"

Replacement Pad: BH-7205



- Fixed Slip-On Height Extension with Octagon Pad**
 BH-7749-85 • 4" Adapter

Fits over Spin-Up
with X Pattern Pad
BH-7750-02

Opening Dimensions:
4-3/16" x 1-1/8"

Replacement Pad: BH-7225-01

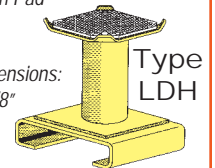

Type
LDH

Adjustable Slip-On Height Extension for Close to Frame Obstructions

Fits over spin-up with flat rectangular pad with X Pattern

- BH-7749-86 4" to 6"
 BH-7749-87 6" to 9"

Replacement Pad: BH-9755-50-1

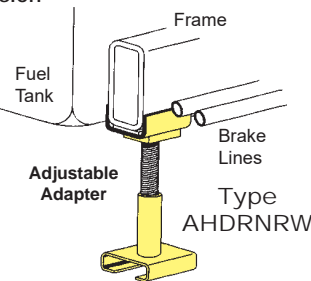

Adjustable
Adapter
Type
AHDRNRW

Opening Dimensions:
4-3/16" x 1-1/8"

Fixed Slip-On Height Extension for Close to Frame Obstructions

Fits over spin-up with flat rectangular pad with X Pattern

- BH-7749-88 3" Adapter
 BH-7749-89 6" Adapter
 BH-7749-90 9" Adapter

Replacement Pad: BH-9755-50-1

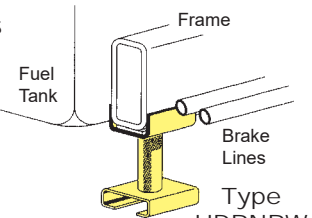

Frame
Fuel Tank
Brake Lines
Type
HDRNRW

Opening Dimensions:
4-3/16" x 1-1/8"

Slip-On Height Extension - Steel Pad

- BH-7760-30 3" Extension
 BH-7760-31 6" Extension
 BH-7760-32 9" Extension

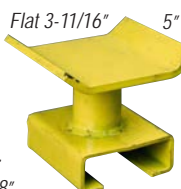

Type
LDM

Opening
Dimensions:
4-3/16" x 1-1/8"

SURX • Screw Up Height Extension Features BH-7750-02 (Ref S-350) 4" x 4.5" Rectangle Slip On Pad

Made to fit any lift using either 1"-8, 1-1/4"-7, or 1-3/8"-6 threads. Identify thread size from the lift you are working on, determine length and select the part number for the items you would like us to ship.

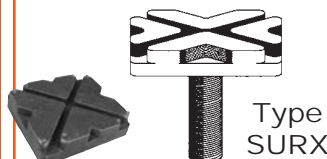

Type
SURX

1"-8 Threads

SVI Part #	Thread Size	Height
BH-7090-79	1"-8	4"

1-1/4"-7 Threads

SVI Part #	Thread Size	Height
BH-7090-80	1-1/4"-7	4"
BH-7090-81	1-1/4"-7	5"
BH-7090-82	1-1/4"-7	6"
BH-7090-83	1-1/4"-7	7"
BH-7090-84	1-1/4"-7	8"

1-3/8"-6 Threads

SVI Part #	Thread Size	Height
BH-7090-85	1-3/8"-6	4"
BH-7090-86	1-3/8"-6	5"
BH-7090-87	1-3/8"-6	6"
BH-7090-88	1-3/8"-6	7"
BH-7090-89	1-3/8"-6	8"



Height Extensions and Adapters By Size

Please always confirm dimensions before ordering. Height Extensions and Adapters come in many different styles and dimensions. SVI is well-known as the adapter expert, specializing in top quality standard and custom adapters. SVI is your answer.

Slip-On Style—Opening Dimensions: 4-1/4" x 3/4"

For Some Models:
Magnum

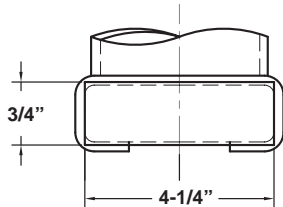

Adapter Base Inside Dimensions
Shape may vary depending on height extension.

Slip-On Height Extension
BH-7496-1005 5" Adapter
BH-7496-1006 6" Adapter

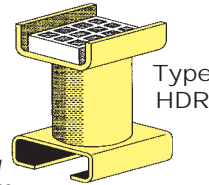

Opening
Dimensions:
4-1/4" x 3/4"

Replacement Pad: BH-7205



Height Extensions and Adapters By Size

Please always confirm dimensions before ordering. Height Extensions and Adapters come in many different styles and dimensions. SVI is well-known as the adapter expert, specializing in top quality standard and custom adapters. SVI is your answer.

Slip-On Style—Opening Dimensions: 4-1/4" x 1-1/8"

These Slip-On Adapters Fit Over SURX Style Spin-Up Adapters with BH-7750-02 X-Pattern Rectangle Rubber Pad

For Some Models:
Grand, American, Eagle, Worth, others

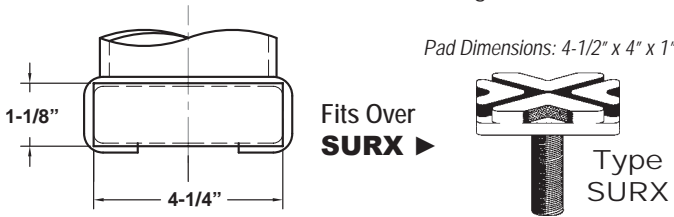

Adapter Base Inside Dimensions
Shape may vary depending on height extension.

Available in Different Threads.
See Below

Slip-On Height Extension with Rectangle Rubber Pad Old Style

- BH-7376-10 3" Extension
- BH-7376-11 4" Extension
- BH-7376-12 5" Extension
- BH-7375-02 6" Extension
- BH-7376-14 7" Extension

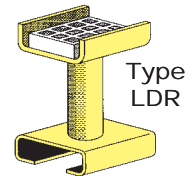

Opening Dimensions:
4-1/4" x 1-1/8"

Fits over Spin-Up with
X-Pattern Rubber Pad

Replacement Pad: BH-7205

Slip-On Height Extension with Rectangle Rubber Pad

- BH-7376-27 3" Extension
- BH-7376-28 4" Extension
- BH-7376-29 5" Extension
- BH-7376-30 6" Extension
- BH-7376-31 7" Extension
- BH-7376-32 8" Extension
- BH-7376-33 9" Extension
- BH-7376-34 10" Extension

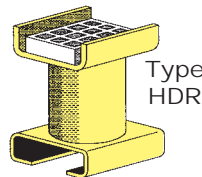

Opening Dimensions:
4-1/4" x 1-1/8"

Fits over Spin-Up with
X-Pattern Rubber Pad

Replacement Pad: BH-7205

Adjustable Slip-On Height Ext.

- BH-7376-40 4" to 6"
- BH-7376-41 6" to 9-1/2"

Type
AHDR

Opening
Dimensions:
4-1/4" x 1-1/8"

Fits over Spin-Up with
X-Pattern Rubber Pad

Replacement Pad: BH-7205

Slip-On Height Extension (No Pad) LDM Style

- BH-7375-40 3" Extension
- BH-7375-41 6" Extension
- BH-7375-42 9" Extension

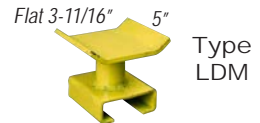

Opening Dimensions: 4-1/4" x 1-1/8"
Fits over Spin-Up with X-Pattern Pad

Adjustable Height Extension for Close to Frame Obstructions AHDNRW Style

- BH-7376-50 4" to 6"
- BH-7376-51 6" to 9"

Fits over Spin-Up with
X-Pattern Rubber Pad

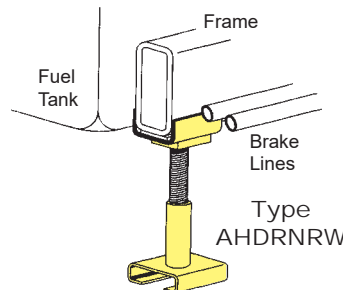

Opening Dimensions:
4-1/4" x 1-1/8"

Replacement Pad: BH-9900-10A

Fixed Slip-On Height Extension for Close to Frame Obstructions

- BH-7376-44 3" Adapter
- BH-7376-45 6" Adapter
- BH-7376-46 9" Adapter

Fits over Spin-Up with
X-Pattern Rubber Pad

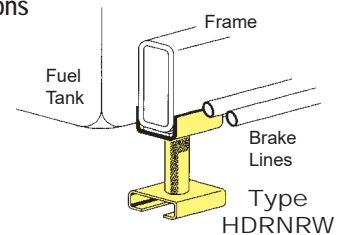

Opening Dimensions:
4-1/4" x 1-1/8"

Replacement Pad: BH-9900-10A

SURX • Screw Up Height Extension Features BH-7750-02 (Ref S-350) 4" x 4.5" Rectangle Slip On Pad

Made to fit any lift using either 1"-8, 1-1/4"-7, or 1-3/8"-6 threads. Identify thread size from the lift you are working on, determine length and select the part number for the items you would like us to ship.

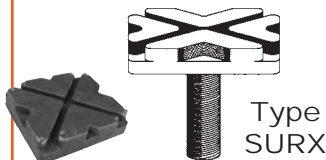

1"-8 Threads

SVI Part #	Thread Size	Height
BH-7090-79	1"-8	4"

1-1/4"-7 Threads

SVI Part #	Thread Size	Height
BH-7090-80	1-1/4"-7	4"
BH-7090-81	1-1/4"-7	5"
BH-7090-82	1-1/4"-7	6"
BH-7090-83	1-1/4"-7	7"
BH-7090-84	1-1/4"-7	8"

1-3/8"-6 Threads

SVI Part #	Thread Size	Height
BH-7090-85	1-3/8"-6	4"
BH-7090-86	1-3/8"-6	5"
BH-7090-87	1-3/8"-6	6"
BH-7090-88	1-3/8"-6	7"
BH-7090-89	1-3/8"-6	8"



Height Extensions and Adapters By Size

Please always confirm dimensions before ordering. Height Extensions and Adapters come in many different styles and dimensions. SVI is well-known as the adapter expert, specializing in top quality standard and custom adapters. SVI is your answer.

Slip-On Style—Opening Dimensions: 4-9/16" x 1-3/16"

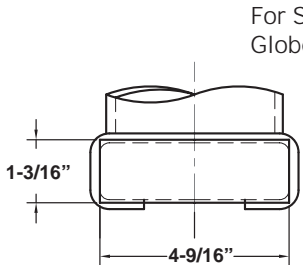

Adapter Base Inside Dimensions
Shape may vary depending on height extension.

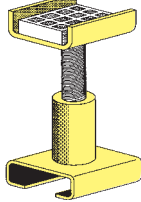
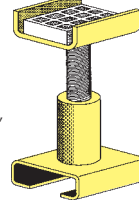
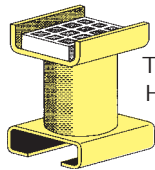
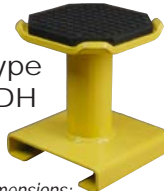
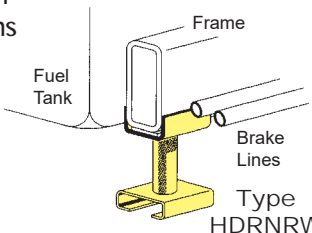
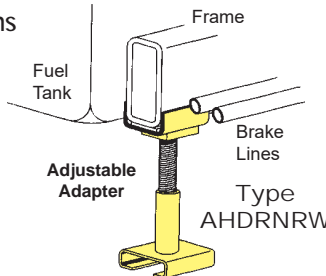
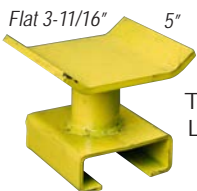
<p>BH-7253-25 4"–6" Adjustable Height Extension w/ Rectangle Pad</p> <p>Type AHDR</p>  <p>Opening Dimensions: 4-9/16" x 1-3/16"</p> <p>Replacement Pad—See BH-7205</p>	<p>BH-7253-26 6"–9-1/2" Adjustable Height Extension w/ Rectangle Pad</p> <p>Type AHDR</p>  <p>Opening Dimensions: 4-9/16" x 1-3/16"</p> <p>Replacement Pad—See BH-7205</p>	<p>Slip-On Height Extension with Rectangle Pad Fits over BH-7250-01 Rubber Pad</p>  <p>Type HDR</p> <p>Opening Dimensions: 4-9/16" x 1-3/16"</p> <table border="0"> <tr><td>BH-7253-27</td><td>3" Extension</td></tr> <tr><td>BH-7253-28</td><td>4" Extension</td></tr> <tr><td>BH-7253-29</td><td>5" Extension</td></tr> <tr><td>BH-7253-30</td><td>7" Extension</td></tr> <tr><td>BH-7253-31</td><td>8" Extension</td></tr> <tr><td>BH-7253-32</td><td>9" Extension</td></tr> <tr><td>BH-7253-33</td><td>10" Extension</td></tr> </table> <p>Replacement Pad: BH-7205</p>	BH-7253-27	3" Extension	BH-7253-28	4" Extension	BH-7253-29	5" Extension	BH-7253-30	7" Extension	BH-7253-31	8" Extension	BH-7253-32	9" Extension	BH-7253-33	10" Extension
BH-7253-27	3" Extension															
BH-7253-28	4" Extension															
BH-7253-29	5" Extension															
BH-7253-30	7" Extension															
BH-7253-31	8" Extension															
BH-7253-32	9" Extension															
BH-7253-33	10" Extension															
<p>Slip-On Height Extension with Octagon Pad Fits over BH-7250-01 Rubber Pad</p> <p>BH-7250-07 6" Extension</p> <p>Other Heights May Be Available Contact SVI Today.</p> <p>Type LDH</p>  <p>Opening Dimensions: 4-9/16" x 1-3/16"</p> <p>Replacement Pad: BH-7235-90A</p>	<p>Fixed Slip-On Height Extension for Close to Frame Obstructions</p> <p>Fits over BH-7250-01 Rectangle Pad</p>  <p>Fuel Tank, Frame, Brake Lines, Type HDRNRW</p> <table border="0"> <tr><td>BH-7253-49</td><td>3" Adapter</td></tr> <tr><td>BH-7253-50</td><td>6" Adapter</td></tr> <tr><td>BH-7253-51</td><td>9" Adapter</td></tr> </table> <p>Opening Dimensions: 4-9/16" x 1-3/16"</p> <p>Replacement Pad: BH-9755-50-1</p>	BH-7253-49	3" Adapter	BH-7253-50	6" Adapter	BH-7253-51	9" Adapter									
BH-7253-49	3" Adapter															
BH-7253-50	6" Adapter															
BH-7253-51	9" Adapter															
<p>Adjustable Slip-On Height Extension for Close to Frame Obstructions</p> <p>Fits over BH-7250-01 Rectangle Pad</p>  <p>Fuel Tank, Frame, Brake Lines, Adjustable Adapter, Type AHDRNRW</p> <table border="0"> <tr><td>BH-7253-54</td><td>4" to 6"</td></tr> <tr><td>BH-7253-55</td><td>6" to 9"</td></tr> </table> <p>Opening Dimensions: 4-9/16" x 1-3/16"</p> <p>Replacement Pad: BH-9755-50-1</p>	BH-7253-54	4" to 6"	BH-7253-55	6" to 9"	<p>Slip-On Height Extension (No Pad) LDM Style</p> <table border="0"> <tr><td>BH-7253-43</td><td>3" Extension</td></tr> <tr><td>BH-7253-44</td><td>6" Extension</td></tr> <tr><td>BH-7253-45</td><td>9" Extension</td></tr> </table>  <p>Flat 3-11/16" 5" Type LDM</p> <p>Opening Dimensions: 4-9/16" x 1-3/16"</p>	BH-7253-43	3" Extension	BH-7253-44	6" Extension	BH-7253-45	9" Extension					
BH-7253-54	4" to 6"															
BH-7253-55	6" to 9"															
BH-7253-43	3" Extension															
BH-7253-44	6" Extension															
BH-7253-45	9" Extension															

Height Extensions and Adapters By Size

Please always confirm dimensions before ordering. Height Extensions and Adapters come in many different styles and dimensions. SVI is well-known as the adapter expert, specializing in top quality standard and custom adapters. SVI is your answer.

Slip-On Style—Opening Dimensions: 4-2/3" x 1"

These Slip-On Adapters Fit Over Some Adapters without Pads

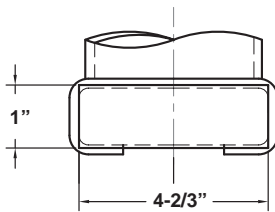

Adapter Base Inside Dimensions
Shape may vary depending on height extension.

For Some Models:
Hydra-Lift

Fixed Slip-On Height Extension with Rectangle Pad

Fits over Hydra-Lift Adapter without Pad

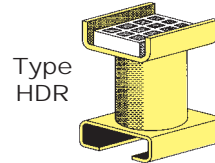

Type HDR

Opening Dimensions:
4-2/3" x 1"

- BH-7290-42 • 3" Adapter
- BH-7290-43 • 4" Adapter
- BH-7290-44 • 5" Adapter
- BH-7290-45 • 6" Adapter
- BH-7290-46 • 7" Adapter
- BH-7290-47 • 8" Adapter
- BH-7290-48 • 9" Adapter
- BH-7290-49 • 10" Adapter

Features Replaceable Rubber Pad BH-7205

Adjustable Height Extension w/ Rectangle Pad

Fits over Adapter without Pad

BH-7290-62 4"–6" Adj.

BH-7290-63 6"–9-1/2" Adj.

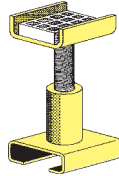

Type AHDR

Opening Dimensions:
4-2/3" x 1"

Replacement Pad—See BH-7205

Fixed Slip-On Height Extension with Octagon Pad

Fits over Hydra-Lift Adapter without Pad

BH-7290-26 • 3" Adapter

BH-7290-27 • 4" Adapter

BH-7290-28 • 5" Adapter

BH-7290-29 • 6" Adapter

BH-7290-30 • 7" Adapter

BH-7290-31 • 8" Adapter

BH-7290-32 • 9" Adapter

BH-7290-33 • 10" Adapter

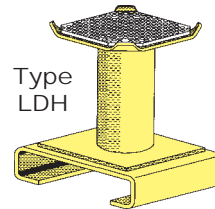

Type LDH

Opening Dimensions:
4-2/3" x 1"

Features Replaceable Rubber Pad BH-7235-90A

Adjustable Height Extension with Octagon Pad

Fits over Adapter without Pad

BH-7290-58 4"–6" Adj.

BH-7290-59 6"–9-1/2" Adj.

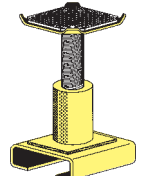

Type ALDH

Opening Dimensions:
4-2/3" x 1"

Replacement Pad—See BH-7235-90A

Adjustable Slip-On Height Extension for Close to Frame Obstructions

Fits over Hydra-Lift Adapter without Pad

BH-7292-54 4" to 6"

BH-7292-55 6" to 9-1/2"

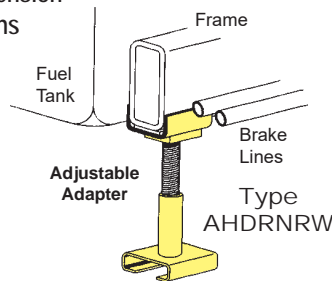

Opening Dimensions:
4-2/3" x 1"

Replacement Pad: BH-9755-50-1

Fixed Slip-On Height Extension for Close to Frame Obstructions

Fits over Hydra-Lift Adapter without Pad

BH-7292-48 3" Adapter

BH-7292-49 6" Adapter

BH-7292-50 9" Adapter

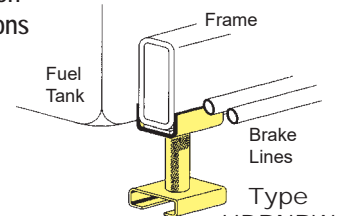

Opening Dimensions:
4-2/3" x 1"

Replacement Pad: BH-9755-50-1

Fixed Slip-On Height Extension with Rectangle Pad

Fits over Hydra-Lift Adapter without Pad

BH-7290-16 • 3" Adapter

BH-7290-17 • 4" Adapter

BH-7290-18 • 5" Adapter

BH-7290-19 • 6" Adapter

BH-7290-20 • 7" Adapter

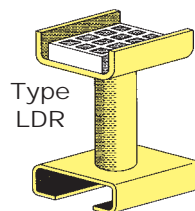

Type LDR

Opening Dimensions:
4-2/3" x 1"

Features Replaceable Rubber Pad BH-7205

Slip-On Height Extension (No Pad)

Fits over Hydra-Lift Adapter without Pad

BH-7290-10 3" Extension

BH-7290-11 6" Extension

BH-7290-12 9" Extension



Type LDM

Opening Dimensions:
4-2/3" x 1"



Height Extensions and Adapters By Size

Please always confirm dimensions before ordering. Height Extensions and Adapters come in many different styles and dimensions. SVI is well-known as the adapter expert, specializing in top quality standard and custom adapters. SVI is your answer.

Slip-On Style—Opening Dimensions: 4-2/3" x 1"

For Some Models:
Hydra-Lift

These Slip-On Adapters Fit Over Some Adapters without Pads

FOR HYDRA-LIFT

Fixed Slip-On Height Extension with Round Pad

Fits over Spin-Up with Round Pad

- BH-7290-66 • 3" Extension
- BH-7290-67 • 4" Extension
- BH-7290-68 • 5" Extension
- BH-7290-69 • 6" Extension
- BH-7290-70 • 7" Extension
- BH-7290-71 • 8" Extension
- BH-7290-72 • 9" Extension
- BH-7290-73 • 10" Extension

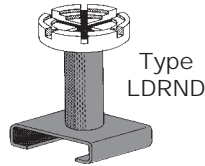

Opening Dimensions:
4-2/3" x 1"

Replacement Pad: BH-7450-02

Slip-On Style—Opening Dimensions: 5-1/8" x 1"

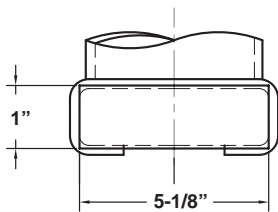

Adapter Base Inside Dimensions
Shape may vary depending on height extension.

For Some Models:
P.M.W.
LINE-O-TRONICS (L.O.T.)
KWIK-WAY

Adjustable Slip-On Height Extension
with Octagon Pad

BH-7438-06 • 6"-9-1/2" Adjustable

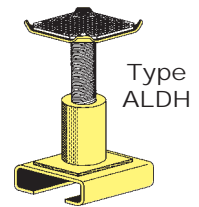

Opening Dimensions:
5-1/8" x 1"

Replacement Pad: BH-7435-07

Height Extensions and Adapters By Size

Please always confirm dimensions before ordering. Height Extensions and Adapters come in many different styles and dimensions. SVI is well-known as the adapter expert, specializing in top quality standard and custom adapters. SVI is your answer.

Slip-On Style—Opening Dimensions: 5-1/8" x 1-5/16"

These Slip-On Adapters Fit Over SUR5 Style Spin-Up Adapters with BH-7450-02 (Ref 10.157) Round Rubber Pad

For Some Models:
Hydra-Lift

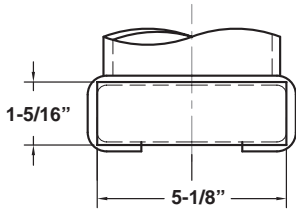

Adapter Base Inside Dimensions
Shape may vary depending on height extension.

Fits Over SUR5
With **BH-7450-02** ▶

Pad Diameter: 4-15/16"

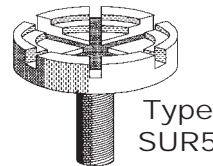

Type
SUR5

Available in Different Threads.
See Next Page.

Round Rubber Arm Pad
(Ref 10.157, 28335)
BH-7450-02 (1) Pad Only
BH-7450-02-4 Set of 4 Pads
with Fasteners

4-15/16" OD
4-25/32" ID
Bottom Side



Fixed Slip-On Height Extension with Round Pad
Fits over Spin-Up with Round Rubber Pad BH-7450-02

- BH-7290-74 • 3" Adapter
- BH-7290-75 • 4" Adapter
- BH-7290-76 • 5" Adapter
- BH-7290-77 • 6" Adapter
- BH-7290-78 • 7" Adapter
- BH-7290-79 • 8" Adapter
- BH-7290-80 • 9" Adapter
- BH-7290-81 • 10" Adapter

Type
LDRND

Opening Dimensions:
5-1/8" x 1-5/16"

Features Replaceable Rubber Pad BH-7450-02

Adjustable Slip-On Height Extension with Round Pad
Fits over Spin-Up with Round Rubber Pad BH-7450-02
Features Replaceable Rubber Pad BH-7450-02

- BH-7290-84 • 4"–6" Adapter
- BH-7290-85 • 6"–9-1/2" Adapter

Type
ALDRND

Opening Dimensions:
5-1/8" x 1-5/16"

Fixed Slip-On Height Extension with Octagon Pad
Fits over Spin-Up with Round Rubber Pad BH-7450-02

- BH-7290-34 • 3" Adapter
- BH-7290-35 • 4" Adapter
- BH-7290-36 • 5" Adapter
- BH-7290-37 • 6" Adapter
- BH-7290-38 • 7" Adapter
- BH-7290-39 • 8" Adapter
- BH-7290-40 • 9" Adapter
- BH-7290-41 • 10" Adapter

Type
LDH

Opening Dimensions:
5-1/8" x 1-5/16"

Features Replaceable Rubber Pad BH-7235-90A

BH-7290-60
4"–6" Adjustable Height
Extension with Octagon Pad
Fits over Spin-Up with Round Rubber Pad BH-7450-02

Type
ALDH

Opening
Dimensions:
5-1/8" x 1-5/16"

Replacement Pad—See BH-7235-90A

BH-7290-61
6"–9-1/2" Adjustable Height
Extension with Octagon Pad
Fits over Spin-Up with Round Rubber Pad BH-7450-02

Type
ALDH

Opening
Dimensions:
5-1/8" x 1-5/16"

Replacement Pad—See BH-7235-90A

Fixed Slip-On Height Extension with Rectangle Pad
Fits over Spin-Up with Round Rubber Pad BH-7450-02

- BH-7290-21 • 3" Adapter
- BH-7290-22 • 4" Adapter
- BH-7290-23 • 5" Adapter
- BH-7290-24 • 6" Adapter
- BH-7290-25 • 7" Adapter

Type
LDR

Opening Dimensions:
5-1/8" x 1-5/16"

Features Replaceable Rubber Pad BH-7205

Fixed Slip-On Height Extension with Rectangle Pad
Fits over Spin-Up with Round Rubber Pad BH-7450-02

- BH-7290-50 • 3" Adapter
- BH-7290-51 • 4" Adapter
- BH-7290-52 • 5" Adapter
- BH-7290-53 • 6" Adapter
- BH-7290-54 • 7" Adapter
- BH-7290-55 • 8" Adapter
- BH-7290-56 • 9" Adapter
- BH-7290-57 • 10" Adapter

Type
HDR

Opening Dimensions:
5-1/8" x 1-5/16"

Features Replaceable Rubber Pad BH-7205



Height Extensions and Adapters By Size

Please always confirm dimensions before ordering. Height Extensions and Adapters come in many different styles and dimensions. SVI is well-known as the adapter expert, specializing in top quality standard and custom adapters. SVI is your answer.

Slip-On Style—Opening Dimensions: 5-1/8" x 1-5/16"

For Some Models:
Hydra-Lift

FOR HYDRA-LIFTS

Slip-On Narrow Height Extension for Close to Frame Obstructions

Fits over Hydra-Lift Adapter with Round Pad

- BH-7292-51 • 3" Extension
- BH-7292-52 • 6" Extension
- BH-7292-53 • 9" Extension

Adjustable version also available.

Replacement Pad: BH-9755-50-1

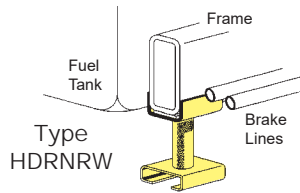

Opening Dimensions:
5-1/8" x 1-5/16"

FOR HYDRA-LIFT

Adjustable Slip-On Narrow Height Extension for Close to Frame Obstructions

Fits over Hydra-Lift Adapter with Round Pad

- BH-7292-56 • 4"-6" Adjustable
- BH-7292-57 • 6"-9-1/2" Adjustable

Replacement Pad: BH-9755-50-1

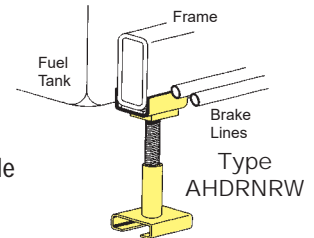

Opening Dimensions:
5-1/8" x 1-5/16"

SUR5 • Screw Up Adapter with Round Pad • Features Replaceable Rubber Pad BH-7450-02 (Ref 10.157, 28335)

Made to fit any lift using either 1-1/4"-7 or 1-3/8"-6 threads. Identify thread size from the lift you are working on, determine length and select the part number for the item(s) you would like us to ship.

Pad Diameter: 4-15/16"

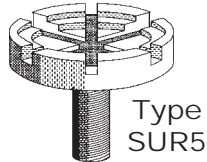

Type SUR5

Includes Replaceable Pad
BH-7450-02

1-1/4"-7 Threads

SVI Part #	Thread Size	Height
BH-7090-60	1-1/4"-7	4"
BH-7090-61	1-1/4"-7	5"
BH-7090-62	1-1/4"-7	6"
BH-7090-63	1-1/4"-7	7"
BH-7090-64	1-1/4"-7	8"

1-3/8"-6 Threads

SVI Part #	Thread Size	Height
BH-7090-65	1-3/8"-6	4"
BH-7090-66	1-3/8"-6	5"
BH-7090-67	1-3/8"-6	6"
BH-7090-68	1-3/8"-6	7"
BH-7090-69	1-3/8"-6	8"
BH-7090-70	1-3/8"-6	9"
BH-7090-71	1-3/8"-6	10"



Height Extensions and Adapters By Size

Please always confirm dimensions before ordering. Height Extensions and Adapters come in many different styles and dimensions. SVI is well-known as the adapter expert, specializing in top quality standard and custom adapters. SVI is your answer.

Slip-On Style—Opening Dimensions: 5-3/16" x 3/4"

These Slip-On Adapters Fit Over BH-7350-00 (K93223) Rubber Arm Pads

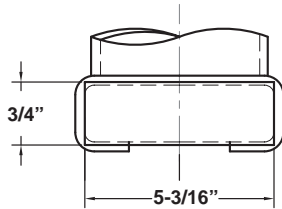

Adapter Base Inside Dimensions
Shape may vary depending on height extension.

Fits Over
BH-7350-00 ▶

Pad: 5-1/8" x 3/4"



Available in Different Threads.
See Next Page.

For Some Models:
Gilbarco
Manitowoc Lifts

Rubber Arm Pad (Ref K93223)

BH-7350-00 1 Arm Pad

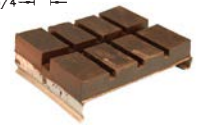
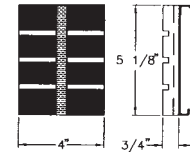

Slip-On Height Extension with Rectangle Rubber Pad

- BH-7353-06 3" Extension
- BH-7353-07 4" Extension
- BH-7353-08 5" Extension
- BH-7353-09 6" Extension
- BH-7353-10 7" Extension

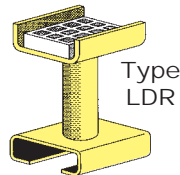

Type
LDR

Opening Dimensions:
5-3/16" x 3/4"

Fits over BH-7350-00 / K93223 Pad

Replacement Pad: BH-7205

Slip-On Height Extension with Rectangle Rubber Pad

- BH-7353-32 3" Extension
- BH-7353-33 4" Extension
- BH-7353-34 5" Extension
- BH-7353-35 6" Extension
- BH-7353-36 7" Extension
- BH-7353-37 8" Extension
- BH-7353-38 9" Extension
- BH-7353-39 10" Extension

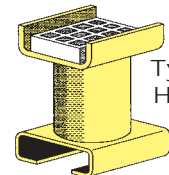

Type
HDR

Opening Dimensions:
5-3/16" x 3/4"

Fits over BH-7350-00 / K93223 Pad

Replacement Pad: BH-7205

Adjustable Slip-On Height Ext.

- BH-7353-52 4" to 6"
- BH-7353-53 6" to 9-1/2"

Type
AHDR

Opening
Dimensions:
5-3/16" x 3/4"

Fits over BH-7350-00 / K93223 Pad

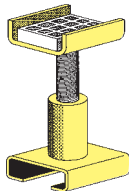

Replacement Pad: BH-7205

Slip-On Height Extension Adapter with Octagon Rubber Pad

- BH-7353-16 3" Extension
- BH-7353-17 4" Extension
- BH-7353-18 5" Extension
- BH-7353-19 6" Extension
- BH-7353-20 7" Extension
- BH-7353-21 8" Extension
- BH-7353-22 9" Extension
- BH-7353-23 10" Extension

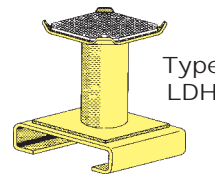

Type
LDH

Opening Dimensions:
5-3/16" x 3/4"

Fits over BH-7350-00 / K93223 Pad

Replacement Pad: BH-7235-90A

Adjustable Slip-On Height Ext.

- BH-7353-48 4" to 6"
- BH-7353-49 6" to 9.5"

Type
ALDH

Opening
Dimensions:
5-3/16" x 3/4"

Fits over BH-7350-00 / K93223 Pad

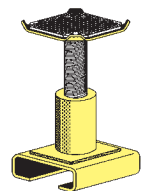

Replacement Pad: BH-7235-90A



Height Extensions and Adapters By Size

Please always confirm dimensions before ordering. Height Extensions and Adapters come in many different styles and dimensions. SVI is well-known as the adapter expert, specializing in top quality standard and custom adapters. SVI is your answer.

Slip-On Style—Opening Dimensions: 5-3/16" x 3/4"

For Some Models:
Gilbarco
Manitowoc Lifts

These Slip-On Adapters Fit Over BH-7350-00 (K93223) Rubber Arm Pads

Adjustable Height Extension for Close to Frame Obstructions AHDRNRW Style

- BH-7353-62 4" to 6"
- BH-7353-63 6" to 9"

Type
AHDRNRW

Fits over BH-7350-00 / K93223 Pad

Replacement Pad: BH-9900-10A

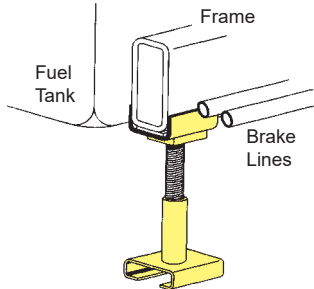

Opening Dimensions:
5-3/16" x 3/4"

Fixed Slip-On Height Extension for Close to Frame Obstructions

- BH-7353-56 3" Adapter
- BH-7353-57 6" Adapter
- BH-7353-58 9" Adapter

Fits over BH-7350-00 / K93223 Pad

Replacement Pad: BH-9900-10A

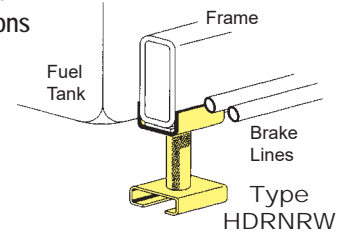

Opening Dimensions:
5-3/16" x 3/4"

Slip-On Height Extension (No Pad) LDM Style

- BH-7353-00 3" Extension
- BH-7353-01 6" Extension
- BH-7353-02 9" Extension

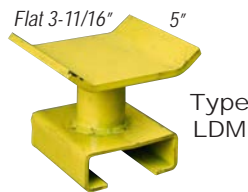

Opening Dimensions:
5-3/16" x 3/4"

Height Extensions and Adapters By Size

Please always confirm dimensions before ordering. Height Extensions and Adapters come in many different styles and dimensions. SVI is well-known as the adapter expert, specializing in top quality standard and custom adapters. SVI is your answer.

Slip-On Style—Opening Dimensions: 5-3/16" x 25/32" For Some Models: Grand

These Slip-On Adapters Fit Over Spin-Up With 4 Corners Turned Up

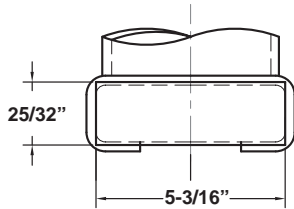

Adapter Base Inside Dimensions
Shape may vary depending on height extension.

Slip-On Height Extension with Rectangle Rubber Pad

- BH-7376-15 3" Extension
- BH-7376-16 4" Extension
- BH-7376-17 5" Extension
- BH-7376-18 6" Extension
- BH-7376-18L 7" Extension

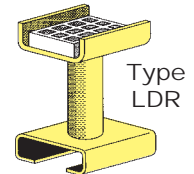

*Opening Dimensions:
5-3/16" x 25/32"*
*Fits over Spin-Up with
four Corners turned up.*

Replacement Pad: BH-7205

Slip-On Height Extension with Rectangle Rubber Pad

- BH-7376-35 3" Extension
- BH-7376-36 4" Extension
- BH-7376-37 5" Extension
- BH-7376-38 6" Extension

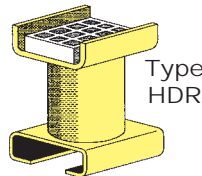

*Opening Dimensions:
5-3/16" x 25/32"*
*Fits over Spin-Up with
four Corners turned up.*

Replacement Pad: BH-7205

Adjustable Slip-On Height Ext.

- BH-7376-42 4" to 6"
- BH-7376-43 6" to 9-1/2"

Type
AHDR

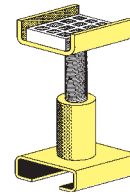

*Opening
Dimensions:
5-3/16" x 25/32"*

*Fits over Spin-Up with
four Corners turned up.*

Replacement Pad: BH-7205

Adjustable Slip-On Height Ext.

- BH-7376-39 4" to 6"
- BH-7376-39H 6" to 9.5"

Type
ALDH

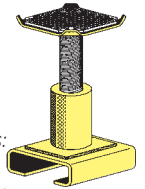

*Opening Dimensions:
5-3/16" x 25/32"*

*Fits over Spin-Up with
four Corners turned up.*

Replacement Pad: BH-7235-90A

Slip-On Height Extension Adapter with Octagon Rubber Pad

- BH-7376-19 3" Extension
- BH-7376-20 4" Extension
- BH-7376-21 5" Extension
- BH-7376-22 6" Extension
- BH-7376-23 7" Extension
- BH-7376-24 8" Extension
- BH-7376-25 9" Extension
- BH-7376-26 10" Extension

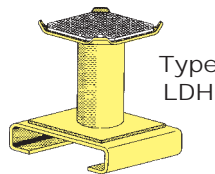

*Opening Dimensions:
5-3/16" x 25/32"*
*Fits over Spin-Up with
four Corners turned up.*

Replacement Pad: BH-7235-90A

Adjustable Height Extension for Close to Frame Obstructions AHDRNRW Style

- BH-7376-52 4" to 6"
- BH-7376-53 6" to 9"

*Fits over Spin-Up with
four Corners turned up.*

Replacement Pad: BH-9900-10A

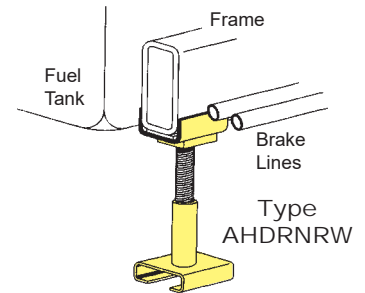

*Opening Dimensions:
5-3/16" x 25/32"*

Fixed Slip-On Height Extension for Close to Frame Obstructions

- BH-7376-47 3" Adapter
- BH-7376-48 6" Adapter
- BH-7376-49 9" Adapter

*Fits over Spin-Up with
four Corners turned up.*

Replacement Pad: BH-9900-10A

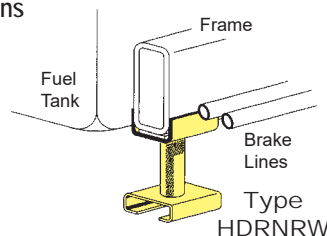

*Opening Dimensions:
5-3/16" x 25/32"*

Slip-On Height Extension (No Pad) LDM Style

- BH-7375-43 3" Extension
- BH-7375-44 6" Extension

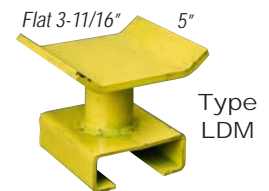

*Opening Dimensions:
5-3/16" x 25/32"*



Height Extensions and Adapters By Size

Please always confirm dimensions before ordering. Height Extensions and Adapters come in many different styles and dimensions. SVI is well-known as the adapter expert, specializing in top quality standard and custom adapters. SVI is your answer.

Slip-On Style—Opening Dimensions: 5-1/4" x 1/2"

These Slip-On Adapters Fit Over Some Spin-Up Adapters without Pad

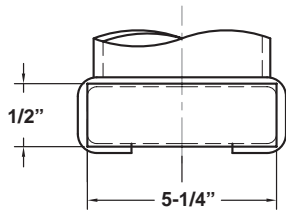

Fits Over Spin-Up Adapter ▶



For Some Models:
Gilbarco
Manitowoc Lifts

Adapter Base Inside Dimensions

Shape may vary depending on height extension.

Slip-On Height Extension with Rectangle Rubber Pad

- BH-7353-11 3" Extension
- BH-7353-12 4" Extension
- BH-7353-13 5" Extension
- BH-7353-14 6" Extension
- BH-7353-15 7" Extension

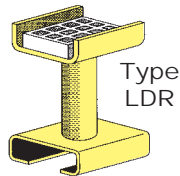

Type LDR

Opening Dimensions:
5-1/4" x 1/2"

Fits over spin-up with 2 sides turned up that had BH-7350-00 / K93223 Pad

Replacement Pad: BH-7205

Slip-On Height Extension with Rectangle Rubber Pad

- BH-7353-40 3" Extension
- BH-7353-41 4" Extension
- BH-7353-42 5" Extension
- BH-7353-43 6" Extension
- BH-7353-44 7" Extension
- BH-7353-45 8" Extension
- BH-7353-46 9" Extension
- BH-7353-47 10" Extension

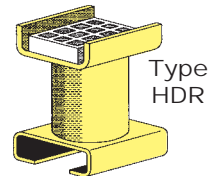

Type HDR

Opening Dimensions:
5-1/4" x 1/2"

Fits over spin-up with 2 sides turned up that had BH-7350-00 / K93223 Pad

Replacement Pad: BH-7205

Adjustable Slip-On Height Ext.

- BH-7353-54 4" to 6"
- BH-7353-55 6" to 9-1/2"

Type AHDR

Opening Dimensions:
5-1/4" x 1/2"

Fits over spin-up with 2 sides turned up that had BH-7350-00 / K93223 Pad

Replacement Pad: BH-7205

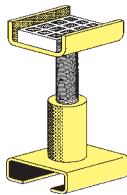

Slip-On Height Extension Adapter with Octagon Rubber Pad

- BH-7353-24 3" Extension
- BH-7353-25 4" Extension
- BH-7353-26 5" Extension
- BH-7353-27 6" Extension
- BH-7353-28 7" Extension
- BH-7353-29 8" Extension
- BH-7353-30 9" Extension
- BH-7353-31 10" Extension
- BH-7353-31L 11" Extension
- BH-7353-31XL 12" Extension

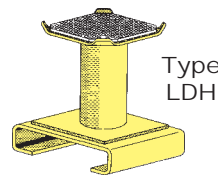

Type LDH

Opening Dimensions:
5-1/4" x 1/2"

Fits over spin-up with 2 sides turned up that had BH-7350-00 / K93223 Pad

Replacement Pad: BH-7235-90A

Adjustable Slip-On Height Ext.

- BH-7353-50 4" to 6"
- BH-7353-51 6" to 9.5"

Type ALDH

Opening Dimensions:
5-1/4" x 1/2"

Fits over spin-up with 2 sides turned up that had BH-7350-00 / K93223 Pad

Replacement Pad: BH-7235-90A

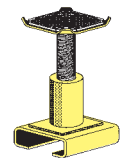

Height Extensions and Adapters By Size

Please always confirm dimensions before ordering. Height Extensions and Adapters come in many different styles and dimensions. SVI is well-known as the adapter expert, specializing in top quality standard and custom adapters. SVI is your answer.

Slip-On Style—Opening Dimensions: 5-1/4" x 1/2"

These Slip-On Adapters Fit Over Some Spin-Up Adapters without Pad

For Some Models:
Gilbarco
Manitowoc Lifts

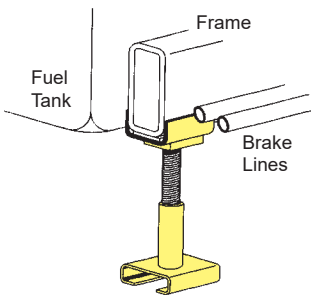
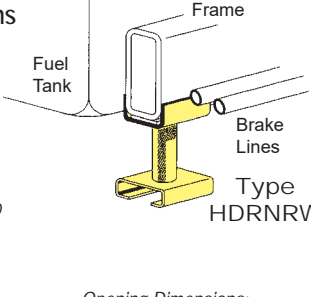
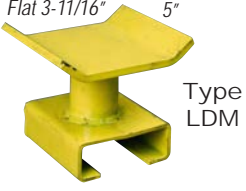
<p>Adjustable Height Extension for Close to Frame Obstructions AHDRNRW Style</p> <p>BH-7353-64 4" to 6" BH-7353-65 6" to 9"</p> <p>Type AHDRNRW</p> <p><i>Fits over spin-up with 2 sides turned up that had BH-7350-00 / K93223 Pad</i></p> <p>Replacement Pad: BH-9900-10A</p>  <p>Opening Dimensions: 5-1/4" x 1/2"</p>	<p>Fixed Slip-On Height Extension for Close to Frame Obstructions</p> <p>BH-7353-59 3" Adapter BH-7353-60 6" Adapter BH-7353-61 9" Adapter</p> <p>Type HDRNRW</p> <p><i>Fits over spin-up with 2 sides turned up that had BH-7350-00 / K93223 Pad</i></p> <p>Replacement Pad: BH-9900-10A</p>  <p>Opening Dimensions: 5-1/4" x 1/2"</p>
<p>Slip-On Height Extension (No Pad) LDM Style</p> <p>BH-7353-03 3" Extension BH-7353-04 6" Extension BH-7353-05 9" Extension</p> <p>Type LDM</p>  <p>Opening Dimensions: 5-1/4" x 1/2"</p>	

FITS OVER • SPIN-UP WITHOUT PAD

Lift Pad Base for Manitowoc / Gilbarco (Ref B-100-62)

BH-7350-44 1 Lift Pad Base

For Use on Models:
CFF-70, CFF-70N, CFF-70S,
CFF-90, CFF-10,000, CBT-70,
CBT-90, and CL-9000





Height Extensions and Adapters By Size

Please always confirm dimensions before ordering. Height Extensions and Adapters come in many different styles and dimensions. SVI is well-known as the adapter expert, specializing in top quality standard and custom adapters. SVI is your answer.

Slip-On Style—Opening Dimensions: 5-3/8" x 1-1/8"

These Slip-On Adapters Fit Over SUR5 Style Spin-Up Adapters with BH-7450-02 (Ref 10.157) Round Rubber Pad

For Some Models:
Force
Nussbaum
Phoenix

Round Rubber Arm Pad
(Ref 10.157, 28335)

BH-7450-02 (1) Pad Only

BH-7450-02-4 Set of 4 Pads with Fasteners

4-15/16" OD
4-25/32" ID
Bottom Side

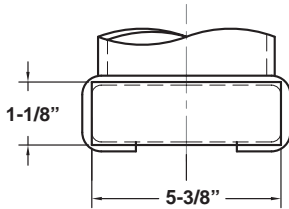

Fits Over SUR5 With **BH-7450-02** ▶

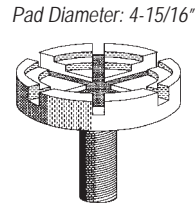

Type SUR5

Available in Different Threads.
See Next Page.

Adapter Base Inside Dimensions
Shape may vary depending on height extension.

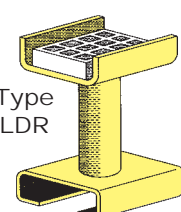
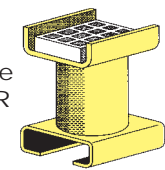
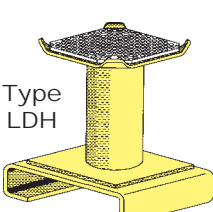
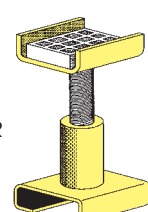
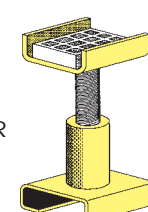
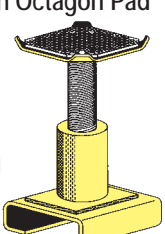
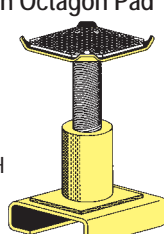
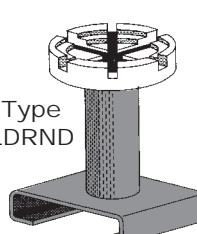
<p>Fixed Slip-On Height Extension Adapter with Rectangle Pad <i>Fits over Spin-Up with Round Pad</i></p> <p>BH-7450-23 • 3" Height Extension BH-7450-24 • 4" Height Extension BH-7450-25 • 5" Height Extension BH-7450-26 • 6" Height Extension BH-7450-27 • 7" Height Extension</p> <p>Type LDR</p>  <p>Opening Dimensions: 5-3/8" x 1-1/8"</p> <p>Features Replaceable Rubber Pad BH-7205</p>	<p>Fixed Slip-On Height Extension with Rectangle Pad <i>Fits over Spin-Up with Round Pad</i></p> <p>BH-7450-36 • 3" Height Extension BH-7450-37 • 4" Height Extension BH-7450-38 • 5" Height Extension BH-7450-39 • 6" Height Extension BH-7450-40 • 7" Height Extension BH-7450-41 • 8" Height Extension BH-7450-42 • 9" Height Extension BH-7450-43 • 10" Height Extension</p> <p>Type HDR</p>  <p>Opening Dimensions: 5-3/8" x 1-1/8"</p> <p>Features Replaceable Rubber Pad BH-7205</p>	
<p>Fixed Slip-On Height Extension Adapter with Octagon Pad <i>Fits over Spin-Up with Round Pad</i></p> <p>BH-7450-28 • 3" Height Extension BH-7450-29 • 4" Height Extension BH-7450-30 • 5" Height Extension BH-7450-03 • 6" Height Extension BH-7450-32 • 7" Height Extension BH-7450-33 • 8" Height Extension BH-7450-34 • 9" Height Extension BH-7450-35 • 10" Height Extension</p> <p>Type LDH</p>  <p>Opening Dimensions: 5-3/8" x 1-1/8"</p> <p>Features Replaceable Rubber Pad BH-7235-90A</p>	<p>BH-7450-46 4"–6" Adjustable Height Extension w/ Rectangle Pad</p> <p><i>Fits over Spin-Up with Round Pad</i></p> <p>Type AHDR</p>  <p>Opening Dimensions: 5-3/8" x 1-1/8"</p> <p>Replacement Pad—See BH-7205</p>	<p>BH-7450-47 6"–9-1/2" Adjustable Height Extension w/ Rectangle Pad</p> <p><i>Fits over Spin-Up with Round Pad</i></p> <p>Type AHDR</p>  <p>Opening Dimensions: 5-3/8" x 1-1/8"</p> <p>Replacement Pad—See BH-7205</p>
<p>BH-7450-44 4"–6" Adjustable Height Extension with Octagon Pad</p> <p><i>Fits over Spin-Up with Round Pad</i></p> <p>Type ALDH</p>  <p>Opening Dimensions: 5-3/8" x 1-1/8"</p> <p>Replacement Pad—See BH-7235-90A</p>	<p>BH-7450-45 6"–9-1/2" Adjustable Height Extension with Octagon Pad</p> <p><i>Fits over Spin-Up with Round Pad</i></p> <p>Type ALDH</p>  <p>Opening Dimensions: 5-3/8" x 1-1/8"</p> <p>Replacement Pad—See BH-7235-90A</p>	<p>Fixed Slip-On Height Extension Adapter with Round Pad <i>Fits over Spin-Up with Round Pad</i></p> <p>BH-7450-48 • 3" Height Extension BH-7450-49 • 4" Height Extension BH-7450-50 • 5" Height Extension BH-7450-04 • 6" Height Extension BH-7450-52 • 7" Height Extension BH-7450-53 • 8" Height Extension BH-7450-54 • 9" Height Extension BH-7450-55 • 10" Height Extension</p> <p>Type LDRND</p>  <p>Opening Dimensions: 5-3/8" x 1-1/8"</p> <p>Features Replaceable Rubber Pad BH-7450-02</p>

Height Extensions and Adapters By Size

Please always confirm dimensions before ordering. Height Extensions and Adapters come in many different styles and dimensions. SVI is well-known as the adapter expert, specializing in top quality standard and custom adapters. SVI is your answer.

Slip-On Style—Opening Dimensions: 5-3/8" x 1-1/8"

For Some Models: Force, Nussbaum, Phoenix

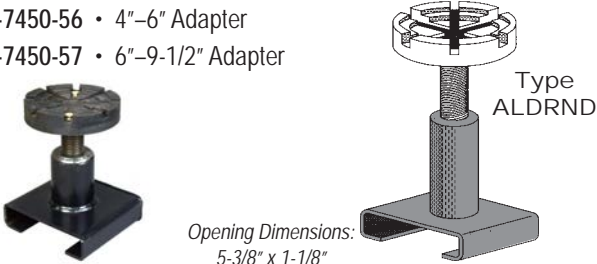
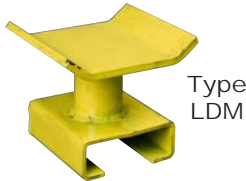
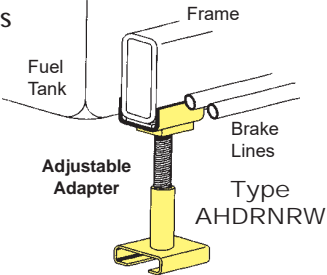
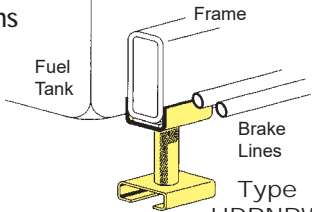

<p>Adjustable Slip-On Height Extension with Round Pad <i>Fits over Spin-Up with Round Pad</i> Features Replaceable Rubber Pad BH-7450-02 BH-7450-56 • 4"–6" Adapter BH-7450-57 • 6"–9-1/2" Adapter</p>  <p>Opening Dimensions: 5-3/8" x 1-1/8"</p>	<p>Slip-On Height Extension (No Pad) <i>Fits over Spin-Up With Round Pad</i></p> <p>BH-7450-20 • 3" Height Extension BH-7450-21 • 6" Height Extension BH-7450-22 • 9" Height Extension</p>  <p>Opening Dimensions: 5-3/8" x 1-1/8"</p>
<p>Adjustable Slip-On Height Extension for Close to Frame Obstructions <i>For Nussbaum Models with Round Rubber Pads</i></p> <p>BH-7450-61 4" to 6" BH-7450-62 6" to 9-1/2"</p>  <p>Opening Dimensions: 5-3/8" x 1-1/8"</p> <p>Replacement Pad: BH-9755-50-1</p>	<p>Fixed Slip-On Height Extension for Close to Frame Obstructions <i>For Nussbaum Models with Round Rubber Pads</i></p> <p>BH-7450-58 3" Adapter BH-7450-59 6" Adapter BH-7450-60 9" Adapter</p>  <p>Opening Dimensions: 5-3/8" x 1-1/8"</p> <p>Replacement Pad: BH-9755-50-1</p>

FITS OVER • SPIN-UP ADAPTER WITH ROUND PAD FOR NUSSAUM, FORCE, PHOENIX, OTHERS

SUR5 • Screw Up Adapter with Round Pad • Features Replaceable Rubber Pad BH-7450-02 (Ref 10.157, 28335)
 Made to fit any lift using either 1-1/4"-7 or 1-3/8"-6 threads. Identify thread size from the lift you are working on, determine length and select the part number for the item(s) you would like us to ship.

Pad Diameter: 4-15/16"

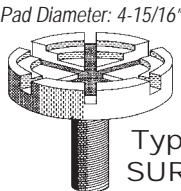
1-1/4"-7 Threads			1-3/8"-6 Threads		
SVI Part #	Thread Size	Height	SVI Part #	Thread Size	Height
BH-7090-60	1-1/4"-7	4"	BH-7090-65	1-3/8"-6	4"
BH-7090-61	1-1/4"-7	5"	BH-7090-66	1-3/8"-6	5"
BH-7090-62	1-1/4"-7	6"	BH-7090-67	1-3/8"-6	6"
BH-7090-63	1-1/4"-7	7"	BH-7090-68	1-3/8"-6	7"
BH-7090-64	1-1/4"-7	8"	BH-7090-69	1-3/8"-6	8"
			BH-7090-70	1-3/8"-6	9"
			BH-7090-71	1-3/8"-6	10"

Includes Replaceable Pad BH-7450-02



Height Extensions and Adapters By Size

Please always confirm dimensions before ordering. Height Extensions and Adapters come in many different styles and dimensions. SVI is well-known as the adapter expert, specializing in top quality standard and custom adapters. SVI is your answer.

Slip-On Style—Opening Dimensions: 5-5/8" x 1-13/16"

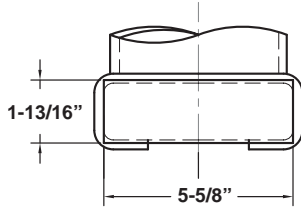

Adapter Base Inside Dimensions
Shape may vary depending on height extension.

For Some Models:
Werther

BH-7587-12
4"–6" Adjustable Height
Extension with Octagon Pad

6" Square Top with
Corners Turned Up

Type
ALDH

Opening
Dimensions:
5-5/8" x 1-3/16"

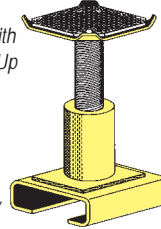

Replacement Pad—See BH-7225-01

BH-7587-13
6"–9-1/2" Adjustable Height
Extension with Octagon Pad

6" Square Top with
Corners Turned Up

Type
ALDH

Opening
Dimensions:
5-5/8" x 1-3/16"

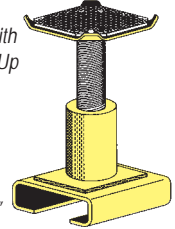

Replacement Pad—See BH-7225-01

Height Extensions and Adapters By Size

Please always confirm dimensions before ordering. Height Extensions and Adapters come in many different styles and dimensions. SVI is well-known as the adapter expert, specializing in top quality standard and custom adapters. SVI is your answer.

Slip-On Style—Opening Dimensions: 5-3/4" x 15/16"

These Slip-On Adapters Fit Over Spin-Up Adapters with Corners Turned Up with BH-7235-90A (Ref 991234, 991222) Octagon Rubber Pad and 5.5" Top
(Note: Fits over VBM Flat Adapters)

For Some Models:
Forward Lifts
VBM (Old Square)
Worth

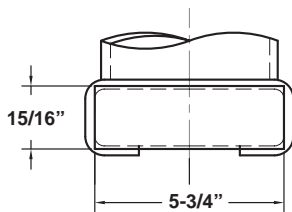

Fits Over SUH5 (5.5" Top)
With **BH-7235-90A** ▶

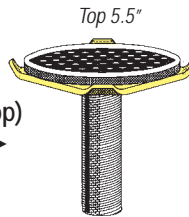

Available in Different Threads.
See Next Page.

Adapter Base Inside Dimensions
Shape may vary depending on height extension.

<p>Fixed Slip-On Height Extension with Octagon Pad <i>Fits over Spin-Up with BH-7235-90A Pad</i></p> <ul style="list-style-type: none"> BH-7236-60 • 3" Adapter BH-7236-61 • 4" Adapter BH-7236-62 • 5" Adapter BH-7235-88 • 6" Adapter BH-7236-63 • 7" Adapter BH-7236-64 • 8" Adapter BH-7236-65 • 9" Adapter BH-7236-66 • 10" Adapter <p>Type LDH Opening Dimensions: 5-3/4" x 15/16"</p> <p>Features Replaceable Rubber Pad BH-7235-90A</p>	<p>BH-7236-77 4"–6" Adjustable Height Extension with Octagon Pad <i>Fits over Spin-Up with BH-7235-90A Pad</i></p> <p>Type ALDH Opening Dimensions: 5-3/4" x 15/16"</p> <p>Replacement Pad: BH-7235-90A</p>	<p>BH-7236-78 6"–9-1/2" Adjustable Height Extension with Octagon Pad <i>Fits over Spin-Up with BH-7235-90A Pad</i></p> <p>Type ALDH Opening Dimensions: 5-3/4" x 15/16"</p> <p>Replacement Pad: BH-7235-90A</p>
<p>Fixed Slip-On Height Extension with Octagon Pad <i>Fits over Spin-Up with BH-7235-90A Pad</i></p> <p>Type HDR Opening Dimensions: 5-3/4" x 15/16"</p> <p>Features Replaceable Rubber Pad BH-7205</p> <ul style="list-style-type: none"> BH-7236-67 • 3" Adapter BH-7236-68 • 4" Adapter BH-7236-69 • 5" Adapter BH-7236-70 • 6" Adapter BH-7236-71 • 7" Adapter BH-7236-72 • 8" Adapter BH-7236-73 • 9" Adapter BH-7236-74 • 10" Adapter BH-7236-75 • 11" Adapter BH-7236-76 • 12" Adapter 	<p>BH-7236-79 4"–6" Adjustable Height Extension w/ Rectangle Pad <i>Fits over Spin-Up with BH-7235-90A Pad</i></p> <p>Type AHDR Opening Dimensions: 5-3/4" x 15/16"</p> <p>Replacement Pad: BH-7205</p>	<p>BH-7236-80 6"–9-1/2" Adjustable Height Extension w/ Rectangle Pad <i>Fits over Spin-Up with BH-7235-90A Pad</i></p> <p>Type AHDR Opening Dimensions: 5-3/4" x 15/16"</p> <p>Replacement Pad: BH-7205</p>
<p>Height Extension for Close to Frame Obstructions</p> <ul style="list-style-type: none"> BH-7236-81 3" Adapter BH-7236-82 6" Adapter BH-7236-83 9" Adapter <p>Type HDRNRW</p> <p><i>Fits over Spin-Up with BH-7235-90A</i></p> <p>Opening Dimensions: 5-3/4" x 15/16"</p> <p>Replacement Pad: BH-9755-50-1</p>	<p>Adjustable Height Extension for Close to Frame Obstructions <i>Fits over Spin-Up with BH-7235-90A Pad</i></p> <ul style="list-style-type: none"> BH-7236-84 4" to 6" BH-7236-85 6" to 9-1/2" <p>Fuel Tank, Frame, Brake Lines, Adjustable Adapter, Type AHDRNRW</p> <p>Opening Dimensions: 5-3/4" x 15/16"</p> <p>Replacement Pad: BH-9755-50-1</p>	<p>Slip-On Height Extension (No Pad) LDM Style</p> <ul style="list-style-type: none"> BH-7235-20 3" Extension BH-7235-21 6" Extension BH-7235-22 9" Extension <p>Type LDM Opening Dimensions: 5-3/4" x 15/16"</p> <p><i>Fits over Spin-Up with BH-7235-90A Pad</i></p>



Height Extensions and Adapters By Size

Please always confirm dimensions before ordering. Height Extensions and Adapters come in many different styles and dimensions. SVI is well-known as the adapter expert, specializing in top quality standard and custom adapters. SVI is your answer.

Slip-On Style—Opening Dimensions: 6-1/8" x 1"

These Slip-On Adapters Fit Over SUH6 Style Spin-Up Adapters with BH-7225-01 (Ref 31057, 200086) Octagon Rubber Pad

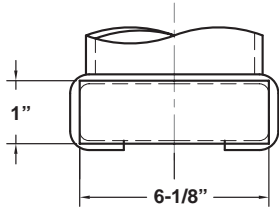

Adapter Base Inside Dimensions
Shape may vary depending on height extension.

Fits Over SUH6
With **BH-7225-01** ▶

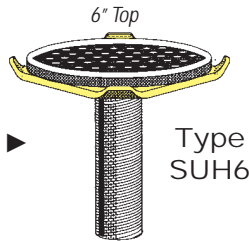

Type SUH6

Available in Different Threads.
See Next Page.

For Some Models:
Ammco (*newer*)
Challenger
VBM

Rubber Arm Pad - Octagon
(Ref 31057, 200086, 11052)

BH-7225-01 1 Pad Only
BH-7225-01-4 Set of 4 Pads
with Fasteners



3/8" Thick
2-Ply

Heavy Duty Version Also Available

Adjustable Slip-On Height Extension with Octagon Pad

Fits over BH-7225-01 Rubber Pad

BH-7227-49 • 4"–6" Adjustable
BH-7227-50 • 6"–9-1/2" Adjustable

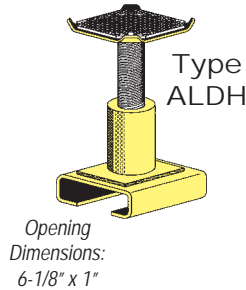

Opening Dimensions:
6-1/8" x 1"

Features Replaceable Rubber Pad BH-7225-01

Adjustable Slip-On Height Extension with Rectangle Pad

Fits over BH-7225-01 Rubber Pad

BH-7227-47 4"–6" Adjustable
BH-7227-48 6"–9-1/2" Adjustable

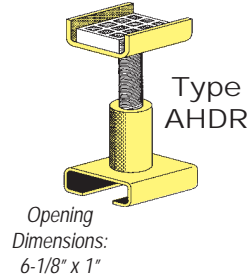

Opening Dimensions:
6-1/8" x 1"

Features Replaceable Rubber Pad BH-7205

Slip-On Height Extension with Octagon Pad

Fits over BH-7225-01 Rubber Pad

BH-7227-23 • 3" Adapter
BH-7227-24 • 4" Adapter
BH-7227-25 • 5" Adapter
BH-7225-02 • 6" Adapter
BH-7227-26 • 7" Adapter
BH-7227-27 • 8" Adapter
BH-7225-05 • 9" Adapter
BH-7227-28 • 10" Adapter
BH-7227-29 • 11" Adapter
BH-7227-30 • 12" Adapter



Opening Dimensions:
6-1/8" x 1"

Features Replaceable Rubber Pad BH-7225-01

Slip-On Height Extension with Rectangle Pad

Fits over BH-7225-01 Rubber Pad

BH-7227-31 • 3" Adapter
BH-7227-32 • 4" Adapter
BH-7227-33 • 5" Adapter
BH-7227-34 • 6" Adapter
BH-7227-35 • 7" Adapter
BH-7227-36 • 8" Adapter
BH-7227-37 • 9" Adapter
BH-7227-38 • 10" Adapter
BH-7227-39 • 11" Adapter
BH-7227-40 • 12" Adapter



Opening Dimensions:
6-1/8" x 1"

Features Replaceable Rubber Pad BH-7205



Height Extensions and Adapters By Size

Please always confirm dimensions before ordering. Height Extensions and Adapters come in many different styles and dimensions. SVI is well-known as the adapter expert, specializing in top quality standard and custom adapters. SVI is your answer.

Slip-On Style—Opening Dimensions: 6-1/8" x 1"

For Some Models:
Ammco (*newer*)
Challenger
VBM

Specialty Wide Adapter for 2019, 2020 and newer Chevrolet 1500 Silverado and GM Sierra Trucks • 3" Slip On
Features 7" Wide Lifting Area • SVI Exclusive

- BH-7227-23GMT (1) 3" Slip On Height Extension
- BH-7542-75P Replacement Pad Only
- BH-7542-75P-4 Replacement Pads (Set of 4)



Fits over BH-7225-01 Rubber Pad
Opening Dimensions 6-1/8" x 1"



FITS OVER • BH-7225-01 RUBBER PAD / SPIN UP WITH 6" TOP

Conversion Pad Assembly 1-1/4"-7 Screw 6" Top
Features Octagon Pad BH-7225-01

Slip-Over Extensions Available!

6" Square Top with Corners Turned Up

Type SUH6



SVI Part #	Ref #	Description
BH-7090-20		Screw-Up Adapter 1-1/4"-7 Height 4"
BH-7090-21		Screw-Up Adapter 1-1/4"-7 Height 5"
BH-7090-22		Screw-Up Adapter 1-1/4"-7 Height 6"
BH-7090-23		Screw-Up Adapter 1-1/4"-7 Height 7"
BH-7090-24		Screw-Up Adapter 1-1/4"-7 Height 8"
BH-7227-41		Screw-Up Adapter 1-1/4"-7 Height 10"
BH-7227-42		Screw-Up Adapter 1-1/4"-7 Height 12"

Conversion Pad Adapter Assembly 6" Top
Features Octagon Pad BH-7225-01
1-3/8"-6 Screw

Slip-Over Height Extensions Available, too! Ask SVI!

6" Square Top with Corners Turned Up

Type SUH6



SVI Part #	Ref #	Description
BH-7225-03	31133	Screw-Up Adapter 1-3/8"-6 Height 3-1/2" 4B31133, 4B100066
BH-7090-25		Screw-Up Adapter 1-3/8"-6 Height 4"
BH-7090-26		Screw-Up Adapter 1-3/8"-6 Height 5"
BH-7090-27		Screw-Up Adapter 1-3/8"-6 Height 6"
BH-7090-28		Screw-Up Adapter 1-3/8"-6 Height 7"
BH-7225-04	10062 / 200083	Screw-Up Adapter 1-3/8"-6 Height 8"
BH-7090-30		Screw-Up Adapter 1-3/8"-6 Height 9"
BH-7090-31		Screw-Up Adapter 1-3/8"-6 Height 10"



Height Extensions and Adapters By Size

Please always confirm dimensions before ordering. Height Extensions and Adapters come in many different styles and dimensions. SVI is well-known as the adapter expert, specializing in top quality standard and custom adapters. SVI is your answer.

Slip-On Style—Opening Dimensions: 6-1/2" x 1-5/16"

These Slip-On Adapters Fit Over SUR6 Style Spin-Up Adapters with BH-7150-02 (Ref A94208) Round Rubber Pad

For Some Models:
ALM

**BH-7150-02 (Ref A94208)
Rubber Lift Pad (1)
Sold Individually**

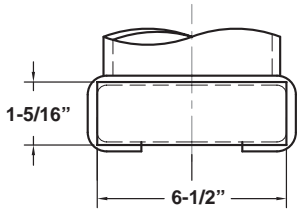

Fits Over **SUR6** ▶
With BH-7150-02

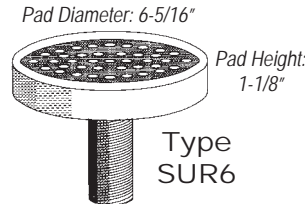

Type
SUR6

Available in Different Threads.
See Next Page.



6-5/16" OD
Bottom Dimensions: 5-7/8" ID with Lip

Adapter Base Inside Dimensions
Shape may vary depending on height extension.

Fixed Slip-On Height Extension with Round Pad
Fits over BH-7150-02 Round Pad
Features Replaceable Rubber Pad BH-7150-02

- BH-7150-22 • 3" Adapter
- BH-7150-23 • 4" Adapter
- BH-7150-24 • 5" Adapter
- BH-7150-03 • 6" Adapter**
- BH-7150-25 • 7" Adapter
- BH-7150-26 • 8" Adapter
- BH-7150-04 • 9" Adapter**
- BH-7150-27 • 10" Adapter

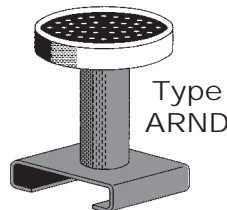

Type
ARND

Opening Dimensions:
6-1/2" x 1-5/16"

BH-7150-28
4"–6" Adjustable Height
Extension with Round Pad

Type
AARND

Opening
Dimensions:
6-1/2" x 1-5/16"

Replacement Pad—See BH-7150-02

BH-7150-29
6"–9-1/2" Adjustable Height
Extension with Round Pad

Type
AARND

Opening
Dimensions:
6-1/2" x 1-5/16"

Replacement Pad—See BH-7150-02

Fixed Slip-On Height Extension with Rectangle Pad
Fits over BH-7150-02 Round Pad
Features Replaceable Rubber Pad BH-7205

- BH-7150-42 • 3" Adapter
- BH-7150-43 • 4" Adapter**
- BH-7150-44 • 5" Adapter
- BH-7150-45 • 6" Adapter**
- BH-7150-46 • 7" Adapter
- BH-7150-47 • 8" Adapter
- BH-7150-48 • 9" Adapter
- BH-7150-49 • 10" Adapter**
- BH-7150-50 • 11" Adapter
- BH-7150-51 • 12" Adapter

Type
HDR

Opening Dimensions:
6-1/2" x 1-5/16"

Replacement Pad—See BH-7205

**Adjustable Height Extension
with Rectangle Pad**
BH-7150-54 4"–6" Adj.
BH-7150-55 6"–9-1/2" Adj.

Type
AHDR

Opening
Dimensions:
6-1/2" x 1-5/16"

Replacement Pad—See BH-7205

Fixed Slip-On Height Extension with Octagon Pad
Fits over BH-7150-02 Round Pad
Features Replaceable Rubber Pad BH-7225-01

- BH-7150-34 • 3" Adapter
- BH-7150-35 • 4" Adapter**
- BH-7150-36 • 5" Adapter
- BH-7150-01 • 6" Adapter**
- BH-7150-37 • 7" Adapter
- BH-7150-39 • 8" Adapter
- BH-7150-40 • 9" Adapter
- BH-7150-41 • 10" Adapter**

Type
LDH

Opening Dimensions:
6-1/2" x 1-5/16"

Replacement Pad—See BH-7225-01

**Adjustable Height Extension
with Octagon Pad**
BH-7150-52 4"–6" Adj.
BH-7150-53 6"–9-1/2" Adj.

Type
ALDH

Opening
Dimensions:
6-1/2" x 1-5/16"

Replacement Pad—See BH-7225-01

**Slip-On Height Extension
(No Pad) LDM Style**

- BH-7150-31 3" Extension
- BH-7150-32 6" Extension
- BH-7150-33 9" Extension

Type
LDM

Flat 3-11/16" 5"

Opening
Dimensions:
6-1/2" x 1-5/16"



Height Extensions and Adapters By Size

Please always confirm dimensions before ordering. Height Extensions and Adapters come in many different styles and dimensions. SVI is well-known as the adapter expert, specializing in top quality standard and custom adapters. SVI is your answer.

For Slip-On Style—Opening Dimensions: 6-1/2" x 1-5/16"

For Some Models:
ALM

<p>Height Extension for Close to Frame Obstructions BH-7150-72 3" Adapter BH-7150-73 6" Adapter BH-7150-74 9" Adapter</p> <p>Type HDRNRW</p> <p><i>Fits over Spin-Up with Round Pad</i></p> <p>Opening Dimensions: 6-1/2" x 1-5/16"</p> <p>Replacement Pad: BH-9900-10A</p>	<p>Adjustable Height Extension for Close to Frame Obstructions BH-7150-75 4" to 6" BH-7150-76 6" to 9"</p> <p>Type AHDRNRW</p> <p><i>Fits over Spin-Up with Round Pad</i></p> <p>Opening Dimensions: 6-1/2" x 1-5/16"</p> <p>Replacement Pad: BH-9900-10A</p>
---	--

FITS OVER • 6-5/16" OD X 1-1/8" TALL ROUND RUBBER PAD

SUR6 • Screw Up Adapter with Round Pad • Features Replaceable Rubber Pad BH-7150-02 (Ref A94208)

Made to fit any lift using either 1-1/4"-7, 1-3/8"-6, or 1-1/2"-6 threads. Identify thread size from the lift you are working on, determine length and select the part number for the item(s) you would like us to ship.



1-1/4"-7 Threads

SVI Part #	Thread Size	Height
BH-7090-40	1-1/4"-7	4"
BH-7090-41	1-1/4"-7	5"
BH-7090-42	1-1/4"-7	6"
BH-7090-43	1-1/4"-7	7"
BH-7090-44	1-1/4"-7	8"

1-3/8"-6 Threads

SVI Part #	Thread Size	Height
BH-7090-45	1-3/8"-6	4"
BH-7090-46	1-3/8"-6	5"
BH-7090-47	1-3/8"-6	6"
BH-7090-48	1-3/8"-6	7"
BH-7090-49	1-3/8"-6	8"
BH-7090-50	1-3/8"-6	9"
BH-7090-51	1-3/8"-6	10"

1-1/2"-6 Threads

SVI Part #	Thread Size	Height
BH-7090-56	1-1/2"-6	3"
BH-7090-57	1-1/2"-6	5"
BH-7090-58	1-1/2"-6	8"



ADJUSTABLE
TURF
 AND UTILITY
TRAYS
 FOR 2-POST LIFTS
 SYMMETRIC / ASYMMETRIC

ADJUSTABLE WIDTH
SYMMETRIC **AWS**

ADJUSTABLE WIDTH
ASYMMETRIC **AWA**

UNIVERSAL STYLE
 TURF TRAYS FOR
 2-POST LIFTS

2800 LB CAPACITY
 (1400 LB / TRAY)

It couldn't be any easier—
 very few, if any measurements
 are needed when ordering
 AWA or AWS TURF TRAYS from SVI!



SVI International, Inc.
 155 Harvestore Drive • DeKalb, IL 60115
 800-321-8173 • 815-748-0200
 E-Mail: parts@sviintl.com
www.sviinternational.com

**TERMS AND CONDITIONS OF THE
SALES ORDER
FOR SVI INTERNATIONAL, INC.**

1. **GENERAL.** The terms and conditions of sales order outlined herein shall apply to the sale by SVI INTERNATIONAL, INC. (hereinafter referred to as "Company") of the items described on the facing page (hereinafter referred to as "Merchandise") to Purchaser.
2. **DELIVERY.** Delivery shall be deemed to be complete when the Merchandise has been shipped F.O.B. Company's plants in DeKalb, Illinois, and Montclair, California; ("Company's plants"). Shipments are subject to delays from causes or contingencies beyond the reasonable control of the Company. When otherwise not specified, shipments will be made in standard containers via carrier which, in the judgment of the Company, will result in the most practical method. Title and right of possession will pass to the Purchaser upon receipt by the carrier at the shipping point. If a customer of the Company should specify a specific carrier's method of shipment (i.e., UPS Next Day Air) and that carrier does not perform to the customer's expectations, freight credit to a customer's account will not be issued unless the Company can first obtain a credit.
3. **RISK OF LOSS.** Identification of the Merchandise under Uniform Commercial Code (hereinafter referred to as "UCC") Section 2-501 shall take place at the moment of shipment F.O.B. Company's plants. Risk of loss shall pass to the Purchaser when the Merchandise is shipped from the Company's plants.
4. **TITLE.** Title to the merchandise shall transfer to the Purchaser when the Merchandise is shipped from the Company's plants.
5. **WARRANTIES.** The Company guarantees its products to be free from defects in workmanship and raw materials for a period of one year from date of purchase. THIS WARRANTY IS EXPRESSLY IN LIEU OF ANY AND ALL WARRANTIES EXPRESS OR IMPLIED. COMPANY DOES NOT WARRANT THE MERCHANDISE IS MERCHANTABILITY OR FIT FOR ANY PARTICULAR PURPOSE. Company's liability for breach of the terms of this Agreement, including any warranty, is limited to either refund of the invoice price of the Merchandise or at Company's option, replacement of the Merchandise free of charge, including transportation charges but not including the cost of labor. Purchaser has not relied on any statement or upon the conduct of Company with respect to the prospective use of the merchandise. Company shall not be liable for, and Purchaser waives any and all claims for any loss or damage, directly or indirectly, arising from the use of the Merchandise and for punitive, incidental or consequential damages, including, but not limited to, damages to property, for loss of use, loss of time, loss of profit or loss of income. The Company does not authorize the sale of our products under any other warranty, expressed or implied. **Please note:** Electrical components and cylinder or shaft seals are not covered under warranty.
6. **SETOFF.** All claims for money due or to become due from the Company shall be subject to deduction by the Company for any setoff or counterclaim arising out of this or any other claims of the Company or its affiliated companies, whether such setoff or counterclaim arose before or after any assignment by Purchaser.
7. **INDEMNIFICATION.** Purchaser agrees to indemnify the Company and hold it harmless from and against all claims, liability, loss, damage, or expense, including reasonable counsel fees, arising from or by reason of any modifications or alterations made by Purchaser. If a customer of the Company modifies or alters any part, in any manner whatsoever, or uses any part in departure from recommended performance specifications, said customer agrees to indemnify and hold the Company harmless from and against all liability and expenses based on damage to property or injury to or death of any person arising out of or attributable to such modified or altered part. Further, the Company will not accept any such modified or altered part for credit to a customer's account.
8. **FREIGHT POLICY.** Freight charges are prepaid and added to invoice or collect FOB shipping point. Note: All customers are responsible for all carrier shipping costs, fees, surcharges, etc. including order refusal and return fees.
9. **RETURN POLICY.** To return a part for credit or inspection, Purchaser must first contact our Main Office in Illinois, to obtain a Return Merchandise Form. Once Purchaser has obtained this form, the parts can be returned freight prepaid only. The Return form must be included with the shipment. Parts returned to the Company without the approved form will be returned freight collect to the shipper or refused. Returns must be initiated within 30 days of the invoice date. The Return Forms are valid for 30 days, from the date of issue. All Returns are subject to restocking charges. Return parts brought into our remote warehouses, will not be accepted by our personnel, without a Return Merchandise Form from the Main Office. Parts which have been used in any way or manner, including any installation or incorporation into a lift, hoist, or other equipment, shall NOT be eligible for return whether or not a Return form has been assigned. **Please note: Electrical parts or components are not returnable for credit.** This includes all switches, pushbuttons, relays, electric motors, capacitors, fuses, solenoids, power units with wiring issues or any other electrical items. Custom, built to order, special order, and non-stocked genuine parts are non-returnable.
10. **RESTOCK CHARGE.** Returns are subject to a restocking charge. Refusals are subject to the same restocking charge plus the cost of outbound and return freight charges and/or fees incurred by the Company due to shipment refusal.
11. **PRICES AND PAYMENTS.** All prices are subject to change without notice. All prices are F.O.B. shipping point. The Company standard terms are net 30 days, C.O.D. company check, C.O.D. cash, VISA, MasterCard, Discover or American Express. However, if in the judgment of the Company, the financial condition of the Purchaser at any time does not justify shipment according to standard terms of payment, the Company may require full or partial payment in advance.
12. **INTERPRETATION.** This sales order is intended by the parties as a complete and exclusive statement of the terms of their agreement. It supersedes all prior agreements, written or oral. No course of prior dealings between the parties and no usage of the trade shall be relevant to supplement or explain any terms used in this sales order. Acceptance or acquiescence in a course of performance rendered under this purchase order shall not be relevant to determine the meaning of this sales order even though the accepting or acquiescing party has knowledge of the nature of the performance and opportunity for objection. Whenever a term defined by the UCC is used in this sales order the definition contained in the UCC shall control.
13. **MODIFICATION.** This sales order can be modified or rescinded only by a writing signed by both parties.
14. **WAIVER.** No claim or right arising out of a breach of this sales order can be discharged in whole or in part by a waiver or renunciation of the claim or right unless such waiver or renunciation is supported by consideration and is in writing signed by the aggrieved party.
15. **ASSIGNMENT.** No right or interest in this sales order shall be assigned by either party without the written consent of the other and no delegation of any obligation owed, or of the performance of any obligation by either the Company or Purchaser shall be made without the written consent of the other party. Any attempted assignment or delegation not made in conformity with this paragraph shall be wholly void and totally ineffective for all purposes.
16. **TIME TO PERFORM AND BRING ACTION.** Time is of the essence of this sales order. Any action for breach of this sales order shall be commenced within two (2) years after the cause of action has accrued. Any party who loses any litigation shall reimburse the other party for costs including reasonable attorney's fees. The exclusive jurisdiction for any legal action shall be the Circuit Court of DeKalb County, Illinois.
17. **APPLICABLE LAW.** This sales order shall be governed by the UCC of Illinois as effective and in force on the date of this sales order.



SVI IS YOUR ANSWER!



DIRECTFIT™

Insist on SVI Direct Fit™
brand Products!



- Air System and Compressor Parts
- Auto Lift Parts for Any Brand
- Auto Lift Cables and Chain
- Auto Lift Power Units and Parts
- Auto Lift Sheaves / Pulleys and Chain Rollers
- Brake Lathe Repair Parts for All Makes
- Exhaust System Products
- Fluid Delivery Repair Parts
- Hose Reels and Hose Stops
- In-Ground Auto Lifts
- Lubrication Equipment Repair Parts
- Petroleum / Service Station Pump and Tank Products
- Repair Parts for Gasboy Consumer Series
- SESM Lifts for ATV/UTV, Golf Cart and More!
- Tire Changer Repair Parts
- Turf Attachments for 2-Post Lifts
- Vehicle Lifting Systems
- Wheel Balancer Accessories

SVI International, Inc.

155 Harvestore Drive • DeKalb, IL 60115

800-321-8173 • 815-748-0200

Fax: 800-899-1784 • 815-748-0210

Entire contents copyright © 2024, SVI International, Inc.

Information and Catalogs Online:
www.sviinternational.com