

SESM

SMALL EQUIPMENT
SHOP MAINTENANCE

Lifts

Platform / Frame,
Undercarriage, or Axle
Engaging Lift Structures



AFFORDABLE • EASY INSTALLATION • NO PIPING • 360° ROTATION

SESM LIFTS ARE PERFECT FOR:

- ATVs / UTVs
- Golf Carts
- Landscape Equipment
- Lawn Mowers
- Motorcycles
- Personal Watercraft
- Small Engine Shops
- Snowmobiles
- And More!



Various Lift Configurations Available

Choose Platform, Frame or Undercarriage-Engaging Lifting Structures

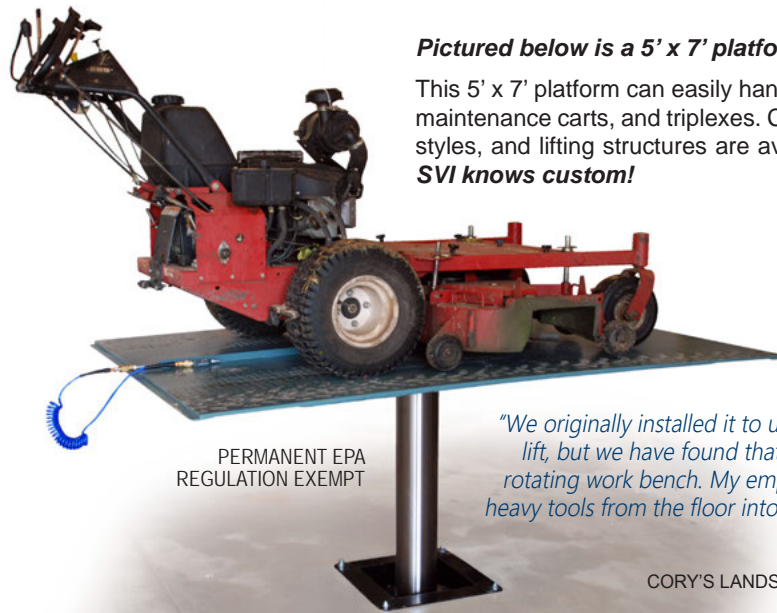

Pictured below is a 5' x 7' platform.

This 5' x 7' platform can easily handle zero turn mowers, maintenance carts, and triplexes. Custom platform sizes, styles, and lifting structures are available upon request. **SVI knows custom!**

PERMANENT EPA
REGULATION EXEMPT

"We originally installed it to use as just an equipment lift, but we have found that it also works great as a rotating work bench. My employees also use it to lift heavy tools from the floor into the back of our trucks."

~ Cory Siegner

CORY'S LANDSCAPING & LAWN SERVICE
SHANNON, ILLINOIS

SVI International, LLC is a leading supplier of high capacity, low pressure single acting cylinders for the automotive lift industry. Effectively a combination of Globe Lift and the former Gilbarco lift division, SVI has an extensive engineering data bank that extends back to 1928. This broad knowledge base and an ever present can-do attitude has driven SVI into many markets as a mainstay supplier of products to increase shop and in-the-field productivity.

SESM lifts from SVI are a perfect solution for those engaged in the sale, service and use of smaller equipment associated with the outdoor power and turf equipment industries. Our style of lifts can be found in golf carts dealerships, landscape equipment maintenance shops, ATV dealers, motorcycle shops and just about anywhere else someone wants to make their job more productive and easier to accomplish.

SVI is a family-owned business that also operates two subsidiary businesses—MLM Lifts and Mfg. (a specialty fabrication shop and hydraulic cylinder company) and Valley Precision Solutions (a customer-specific hydraulic seal company). Great pride is taken in the job we do, as SVI is an America-First enterprise. We support American jobs, American craftsmanship, American engineering and all the American companies we can proudly call our customers. Please put an SESM lift to work for you in your shop today. Become a fan of SVI and add to our growing list of wonderful testimonials from satisfied customers. You will not be disappointed.

SVI International, LLC

155 HARVESTORE DRIVE • DEKALB, IL

800-321-8173

815-748-0200

www.sviinternational.com

*outperform competitors and your expectations.
own the coolest piece of equipment in your shop.*

EQUIPMENT DEALER SHOWROOM
VERSIONS ALSO AVAILABLE!
Proudly Display Your Best Equipment
on a Brilliant Chrome-Plated Lift Platform.
Request a Showroom Version today!

SESM LIFT IDEAL USES:

- Clutch Changes
- Engine Service
- Blade Sharpening
- Wheel Removal
- Cutting Deck Removal
- Equipment Cleaning
- General Maintenance
- Pickup Truck Loading and Unloading
- Oil Changes
- Brake Work
- Fuel System Service
- Belt Replacement
- Showroom Display

Showroom
Versions

benefits *Install Anywhere*

Showroom lifts are ideal for two significant reasons.

Every dealer providing top quality equipment can use a showroom lift to help increase sales of mowers, golf carts, ATVs, or any other equipment, and at the same time demonstrate platform lifts to clients that are conscientious about improving their own productivity.

FIRST—A platform style showroom lift will bring your best equipment up to an easier height for customer viewing. No one is bending over to look at controls or other features. For example, putting an awesome zero-turn mower up on a platform will allow your sales personnel to easily point to and discuss the mower's features and benefits making the selection process easier and more enjoyable for your customers. Plus, it spins around a full 360° to keep your customer in place while you are discussing all the important reasons they should own the equipment you represent. Put the equipment up at everyone's height, put an end to all the bending over and increase your sales.

SECOND—Proudly displaying your flagship equipment on a platform lift will lead to the next sale. As an SVI dealer, every large customer you deal with will recognize the benefit of improved shop productivity that an SESM lift delivers. There are just so many shop uses and once your customers start installing lifts in their shops they won't know how they ever got along without one. Testimonials and words of praise will soon become common occurrences in your showroom. You'll soon hear your customers say, "The SVI lift you sold me was the best investment I could've ever made for my shop. Thanks for suggesting it!"

- Work at your height, not the floor height
- Helps recruit and retain the best shop technicians
- Operates off shop-air compressor / Self-contained unit, no under floor piping, no external air/oil tank
- Capacities from 1,000 lbs. to 25,000+ lbs. For larger capacities, ask about our LESMs.
- Various Stroke Lengths and Cylinder Sizes
- Compatible with all Hydraulic Fluids including coast Guard and US Forestry Service Approved Environmentally Safe Fluids
- Design that lasts more than a lifetime
- Easy-to-service, only 1 moving part!
- Greatly improves shop productivity
- Ideal for rental properties—this lift is easily removed for relocation. Simply unbolt from the floor and remove. Add some backfill to existing hole and patch the concrete like it was never there. Reinstall lift in your new location.
- Must-have for busy shops
- 360° rotation keeps you between the work and the workbench
- No obstruction when lowered—park right over it.
- Safer than a scissor lift—SESM lifts have fewer pinch points and is less of a trip hazard with the lowered height far less than a collapsed scissor lift or a lowered 2-post lift. Fewer moving parts on the SESM lifts also results in less maintenance than a scissor lift or a 2-post lift.
- Superior operation and safety compared to imported above-ground lifts
- Get the real deal for All-American shops — Welded together by Americans for Americans!
- The best purchase a shop owner/operator can make!

ALSO AVAILABLE:

LESM Lifts

LARGE EQUIPMENT SHOP MAINTENANCE

Larger Versions Available for Large Tractors,
Ag Equipment, Skid Steers and More!
Capacities Possible to over 100,000 lbs.



www.sviinternational.com

~ DOES NOT REQUIRE ELECTRICITY OR HYDRAULIC PUMP ~



Fiberglass Encapsulated Casing Protects From Corrosion (Standard)

HOW THE LIFT WORKS

This semi-hydraulic air/oil lift may be the easiest lift to operate in the world. Simply connect a flexible shop air line to the supplied valve control line and depress the valve introducing air to raise the lift. Once raised to the desired height, release the valve, disconnect your air line and the valve control line if you wish. The lift will stay up in place. When it is time to lower the lift, reconnect the valve control line (if you removed it), and depress the valve. The air will slowly discharge through the valve and the lift will return back to the floor. Or, release the valve at any point during descent and the lift will promptly stop going down for your next work level. **It's that easy!**

Valve Control Line (Standard)

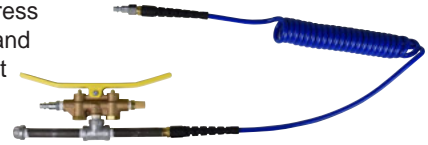

options

- TDC chrome-plated plungers — *Make it last forever!*
- Various style of wheel chocks made of steel and rubber
- Rubber Stack Pads (1-1/2" or 3" Tall)
- Safety Leg / Non-Rotator
- Safety Leg / Rotator to allow full 360° rotation of the platform

FRAME, UNDERCARRIAGE, OR AXLE ENGAGING SUPERSTRUCTURES

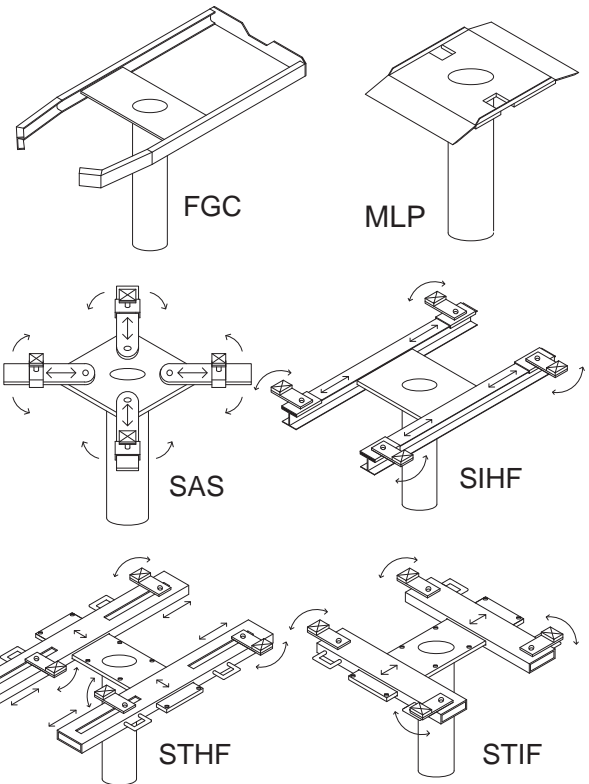

TDC Chrome-Plated Plungers



Rubber Stack Pads for Wheel Service Applications

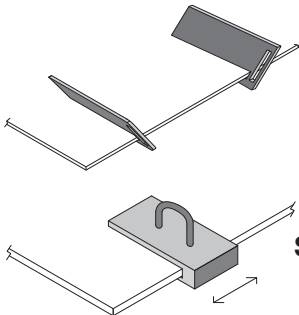

Wheel Chocks in Various Styles

Sliding Hold Down Anchor Point



Safety Leg Non-Rotator

EASY INSTALLATION OF SESM LIFTS — Installs in 3 Hours or Less!!



Simply saw through concrete.



Auger hole for cylinder.



Place cylinder in hole.

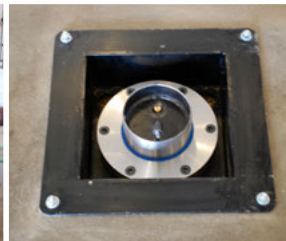

Drill holes, anchor down, and add fluid.



Install Lifting Structure and take full advantage of your cool time-saving tool.



A Family-Owned Enterprise

SVI International, LLC
800-321-8173 • 815-748-0200

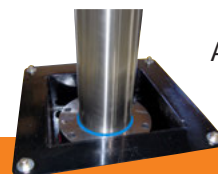

All SVI Lifts are Made in DeKalb, Illinois USA

HOW TO ORDER

Please refer to the charts below for example models. For Example: SESM-6536-6084-D-SR is a platform lift with a 6-1/2" Plunger with a 36" Stroke and a 5'x7' Rectangular Diamond-Plate Platform and a Safety Leg Rotator

SQUARE OR RECTANGULAR PLATFORMS



Plunger Diameter	
50	= 5"
65	= 6-1/2"
85	= 8-1/2"
10	= 10-5/8"
12	= 12-5/8"

Platform Width		
30"	54"	84"
36"	60"	90"
42"	66"	96"
48"	72"	102"

Platform Style	
D	= Diamond Plate
F	= Flat Plate

SESM-6536-6084-D-SR

Stroke Length	
30"	54"
36"	60"
42"	66"
48"	72"

Platform Length		
30"	54"	84"
36"	60"	90"
42"	66"	96"
48"	72"	102"

Safety Leg	
NS	= No Safety Leg
SR	= Safety Leg Rotator
SN	= Safety Leg Non-Rotator

ROUND PLATFORMS



Plunger Diameter	
50	= 5"
65	= 6-1/2"
85	= 8-1/2"
10	= 10-5/8"
12	= 12-5/8"

Platform Style	
D	= Diamond Plate
F	= Flat Plate

SESM-6536-R84-D-SR

Stroke Length	
30"	54"
36"	60"
42"	66"
48"	72"

Platform Diameter (R for Round)	
R30"	R48"
R36"	R54"
R42"	R60"

Safety Leg	
NS	= No Safety Leg
SR	= Safety Leg Rotator
SN	= Safety Leg Non-Rotator

FRAME, UNDERCARRIAGE, OR AXLE ENGAGING SUPERSTRUCTURES

Plunger Diameter	
50	= 5"
65	= 6-1/2"
85	= 8-1/2"
10	= 10-5/8"
12	= 12-5/8"

Platform Style	
D	= Diamond Plate
F	= Flat Plate

Safety Leg	
NS	= No Safety Leg
SR	= Safety Leg Rotator
SN	= Safety Leg Non-Rotator

SESM-6536-____-D-SR

GROSS LIFT CAPACITY IN LBS.

CYL. SIZE @ 100psi	125psi	165psi
5"	1500	1900
6.5"	2600	3300
8.5"	4500	5600
10.625"	7000	8800
12.625"	10,000	12,500
		16,500

Note: Actual lifting capacity will vary based on platform or lifting superstructure designed load capacity, its weight, and load distribution.

Stroke Length	
30"	54"
36"	60"
42"	66"
48"	72"

Superstructure Style	
FGC	= Fixed Golf Cart Lift Structure
MLP	= Motorcycle Lift Platform
SAS	= Swing Arm Sliding Adapters
SIHF	= Sliding Adapter "I" Beam "H" Frame
STHF	= Sliding Tube Swivel Adapter "H" Frame
STIF	= Sliding Tube Swivel Adapter "I" Frame

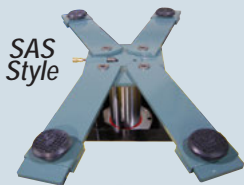

Various Lifting Platforms and Superstructures Available!

Lift ATVs / UTVs, Golf Carts, Motorcycles, Mowers, and much more!

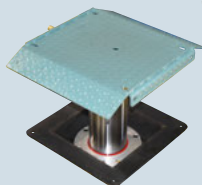

ML Series for Motorcycles



STHF Style

SVI knows custom.

This is just a small sampling of various sizes and options we offer. If you don't see the dimensions or specifications you're looking for, no problem! Let us know and we'll work with you to make the lift to meet your needs!



SVI International, LLC

800-321-8173 • 815-748-0200

www.sviinternational.com