

Automotive Lift

R E P A I R P A R T S



SVI International, Inc.
(800) 321-8173 • fax: (800) 899-1784
155 Harvestore Drive • DeKalb, IL 60115
www.sviinternational.com

BALTIMORE • CHICAGO • LOS ANGELES

Repair Parts for: **ALM**

Repair Parts for:

ALM

LRC7150

Height Extensions and Rubber Pads

SVI Part #	Ext. Style	Ext. Height	Opening Width	Opening Height	Features Rubber Pad
BH-7150-43	HDR	4"	6-9/16"	1-5/16"	BH-7205
BH-7150-45	HDR	6"	6-9/16"	1-5/16"	BH-7205
BH-7150-49	HDR	10"	6-9/16"	1-5/16"	BH-7205
BH-7150-35	LDH	4"	6-1/2"	1-5/16"	BH-7225-01
BH-7150-01	LDH	6"	6-1/2"	1-5/16"	BH-7225-01
BH-7150-41	LDH	10"	6-1/2"	1-5/16"	BH-7225-01
BH-7150-52	ALDH	4-6"	6-1/2"	1-5/16"	BH-7225-01
BH-7150-53	ALDH	6-9.5"	6-1/2"	1-5/16"	BH-7225-01
BH-7150-54	AHDR	4-6"	6-1/2"	1-5/16"	BH-7205
BH-7150-55	AHDR	6-9.5"	6-1/2"	1-5/16"	BH-7205
BH-7150-75	AHDRNRW	4-6"	6-9/16"	1-5/16"	BH-7205
BH-7150-76	AHDRNRW	6-9"	6-9/16"	1-5/16"	BH-7205
BH-7150-03	ARND	6"	6-9/16"	1-5/16"	BH-7150-02
BH-7150-04	ARND	9"	6-9/16"	1-5/16"	BH-7150-02
BH-7150-28	AARND	4-6"	6-9/16"	1-5/16"	BH-7150-02
BH-7150-29	AARND	6-9.5"	6-9/16"	1-5/16"	BH-7150-02

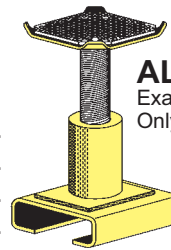

ALDH
Example Only

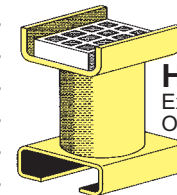
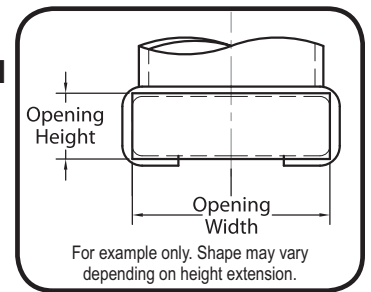

HDR
Example Only

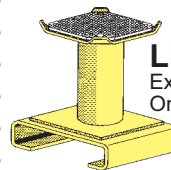

LDH
Example Only



BH-7150-02



BH-7225-01

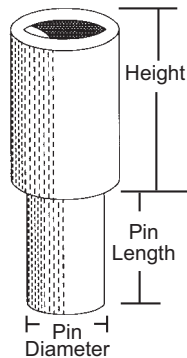

Nesting Style

SVI Part #	Height	Pin Length	Pin Diameter
BH-7533-98S	2-1/2"	1-1/2"	1-1/2"
BH-7101-02	2-5/8"	2"	1-1/2"
BH-7090-14	3"	2"	1-1/2"
BH-7101-04	3-1/2"	2"	1-1/2"
BH-7533-96	4"	1-1/2"	1-1/2"
BH-7090-15	4"	2"	1-1/2"
BH-7101-03	5"	2"	1-1/2"
BH-7090-16	6"	2"	1-1/2"
BH-7090-17	7"	2"	1-1/2"
BH-7533-97	8"	3-1/8"	1-1/2"

For Nesting Style, please verify pin diameter used on the lift before ordering.

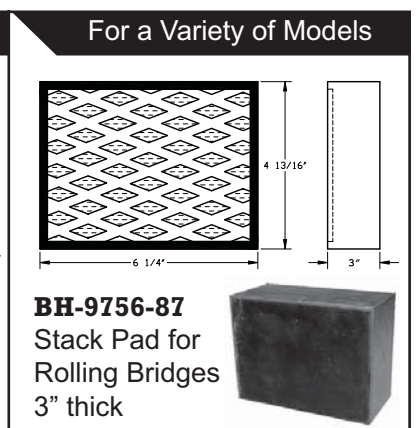
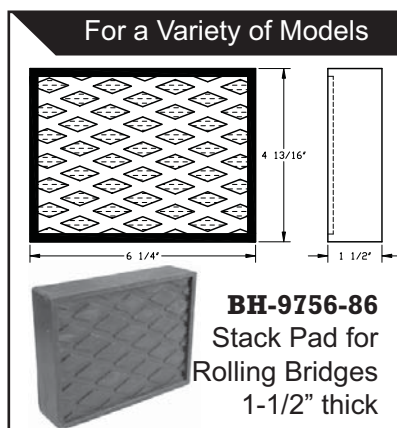
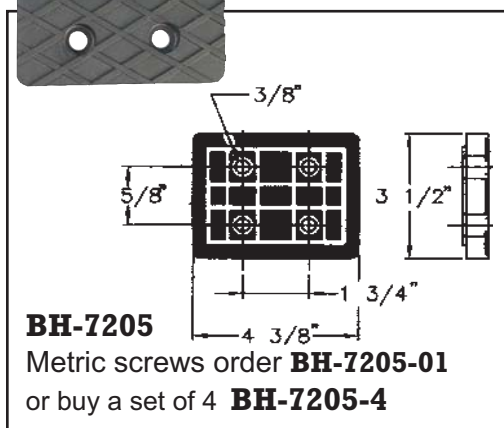

We have many nesting style extensions to fit your lift!

All names, numbers, symbols and descriptions are used for reference purposes only. It is not implied that any part listed is the product of these manufacturers; however, some parts may be the actual product of these manufacturers.

**TERMS AND CONDITIONS OF THE
SALES ORDER
FOR SVI INTERNATIONAL, INC.**

1. **GENERAL.** The terms and conditions of sales order outlined herein shall apply to the sale by SVI INTERNATIONAL, INC. (hereinafter referred to as "Company") of the items described on the facing page (hereinafter referred to as "Merchandise") to Purchaser.
2. **DELIVERY.** Delivery shall be deemed to be complete when the Merchandise has been shipped F.O.B. Company's plants in DeKalb, Illinois, Duarte, California; and Baltimore, Maryland ("Company's plants"). Shipments are subject to delays from causes or contingencies beyond the reasonable control of the Company. When otherwise not specified, shipments will be made in standard containers via carrier which, in the judgment of the Company, will result in the most practical method. Title and right of possession will pass to the Purchaser upon receipt by the carrier at the shipping point. If a customer of the Company should specify a specific carrier's method of shipment (i.e. UPS Next Day Air) and that carrier does not perform to the customer's expectations, freight credit to a customer's account will not be issued unless the Company can first obtain a credit.
3. **RISK OF LOSS.** Identification of the Merchandise under Uniform Commercial Code (hereinafter referred to as "UCC") Section 2-501 shall take place at the moment of shipment F.O.B. Company's plants. Risk of loss shall pass to the Purchaser when the Merchandise is shipped from the Company's plants.
4. **TITLE.** Title to the merchandise shall transfer to the Purchaser when the Merchandise is shipped from the Company's plants.
5. **WARRANTIES.** The Company guarantees its products to be free from defects in workmanship and raw materials for a period of one year from date of purchase. THIS WARRANTY IS EXPRESSLY IN LIEU OF ANY AND ALL WARRANTIES EXPRESS OR IMPLIED. COMPANY DOES NOT WARRANT THE MERCHANDISE IS MERCHANTABLE OR FIT FOR ANY PARTICULAR PURPOSE. Company's liability for breach of the terms of this Agreement, including any warranty, is limited to either refund of the invoice price of the Merchandise or at Company's option, replacement of the Merchandise free of charge, including transportation charges but not including the cost of labor. Purchaser has not relied on any statement or upon the conduct of Company with respect to the prospective use of the merchandise. Company shall not be liable for and Purchaser waives any and all claims for any loss or damage, directly or indirectly, arising from the use of the Merchandise and for punitive, incidental or consequential damages, including, but not limited to, damages to property, for loss of use, loss of time, loss of profit or loss of income. The Company does not authorize the sale of our products under any other warranty, expressed or implied.
6. **SETOFF.** All claims for money due or to become due from the Company shall be subject to deduction by the Company for any setoff or counterclaim arising out of this or any other claims of the Company or its affiliated companies, whether such setoff or counterclaim arose before or after any assignment by Purchaser.
7. **INDEMNIFICATION.** Purchaser agrees to indemnify the Company and hold it harmless from and against all claims, liability, loss, damage or expense, including reasonable counsel fees, arising from or by reason of any modifications or alterations made by Purchaser. If a customer of the Company modifies or alters any part, in any manner whatsoever, or uses any part in departure from recommended performance specifications, said customer agrees to indemnify and hold the Company harmless from and against all liability and expenses based on damage to property or injury to or death of any person arising out of or attributable to such modified or altered part. Further, the Company will not accept any such modified or altered part for credit to a customer's account.
8. **FREIGHT POLICY.** Freight charges on individual orders less than \$3,000 in net value are prepaid and added to invoice or collect F.O.B. shipping point. Freight charges (standard ground service and continental US only) on individual orders more than \$3,000 net value are paid by the Company F.O.B. shipping point. Note: customers with C.O.D. terms are responsible for all carrier C.O.D. fees regardless of order net value.
9. **RETURN POLICY.** To return parts for credit or inspection Purchaser must first contact the Company to obtain a Return Goods Authorization number (RGA#). Once Purchaser has obtained an RGA# the parts can be returned freight prepaid only. The RGA# must be on the outside of the container in a highly visible location. All parts must be returned freight prepaid and the shipment must include a letter of explanation giving the specific reason for return including details as to the conditions under which the part or parts operated. Note: parts returned without an RGA#, freight collect or without written explanation may be refused. Parts which have been used in any way or manner, including any installation or incorporation into a lift or hoist, shall NOT be eligible for return whether or not an RGA has been assigned.
10. **RESTOCK CHARGE.** Returns are subject to up to twenty-five (25%) restocking charge. Refusals are subject to the same restocking charge plus the cost of outbound and return freight charges and/or fees incurred by the Company due to shipment refusal.
11. **PRICES AND PAYMENTS.** All prices are subject to change without notice. All prices are F.O.B. shipping point. The Company standard terms are net 30 days, C.O.D. company check, C.O.D. cash, VISA, MasterCard, Discover or American Express. However, if in the judgment of the Company, the financial condition of the Purchaser at any time does not justify shipment according to standard terms of payment, the Company may require full or partial payment in advance.
12. **INTERPRETATION.** This sales order is intended by the parties as a complete and exclusive statement of the terms of their agreement. It supersedes all prior agreements, written or oral. No course of prior dealings between the parties and no usage of the trade shall be relevant to supplement or explain any terms used in this sales order. Acceptance or acquiescence in a course of performance rendered under this purchase order shall not be relevant to determine the meaning of this sales order even though the accepting or acquiescing party has knowledge of the nature of the performance and opportunity for objection. Whenever a term defined by the UCC is used in this sales order the definition contained in the UCC shall control.
13. **MODIFICATION.** This sales order can be modified or rescinded only by a writing signed by both parties.
14. **WAIVER.** No claim or right arising out of a breach of this sales order can be discharged in whole or in part by a waiver or renunciation of the claim or right unless such waiver or renunciation is supported by consideration and is in writing signed by the aggrieved party.
15. **ASSIGNMENT.** No right or interest in this sales order shall be assigned by either party without the written consent of the other and no delegation of any obligation owed, or of the performance of any obligation by either the Company or Purchaser shall be made without the written consent of the other party. Any attempted assignment or delegation not made in conformity with this paragraph shall be wholly void and totally ineffective for all purposes.
16. **TIME TO PERFORM AND BRING ACTION.** Time is of the essence of this sales order. Any action for breach of this sales order shall be commenced within two (2) years after the cause of action has accrued. Any party who loses any litigation shall reimburse the other party for costs including reasonable attorneys fees. The exclusive jurisdiction for any legal action shall be the Circuit Court of DeKalb County, Illinois.
17. **APPLICABLE LAW.** This sales order shall be governed by the UCC of Illinois as effective and in force on the date of this sales order.

Offering the Best in Automotive Lift Repair Parts and More!

Auto Lift Cables • Auto Lift Parts • Brake Lathe Repair Parts

Compressed Air Repair Parts • Exhaust System Products • Fluid Delivery Repair Parts

Lubrication Equipment Repair Parts • Repair Parts for Gasboy Consumer Series

Service Station Pump and Tank Products • SVI Misc Auto Lift Products and Catalogs

Tire Changer Repair Parts • Vehicle Lifting Systems • Wheel Balancer Accessories

Serving the Industry Since 1977 • Same-Day Shipping



SVI International, Inc.

(800) 321-8173 • fax: (800) 899-1784

155 Harvestore Drive • DeKalb, IL 60115

www.sviinternational.com

BALTIMORE • CHICAGO • LOS ANGELES

While the utmost care has been used in compiling this reference material, we assume no responsibility for errors. Specifications are subject to change without notice. This edition supersedes all previous editions or issues. SVI reference material is subject to change without notice. All rights reserved.