

### For your alignment customers, 10-5/8" replacement single post cylinder kits now available

After fielding many requests from distributors, SVI has expanded its replacement lift cylinder line

Many of you do work for Firestone and Goodyear tire centers. These lift users have some pretty expensive alignment equipment sitting on old single post lifts. When alignment rack lifting units need to be replaced, SVI can help.

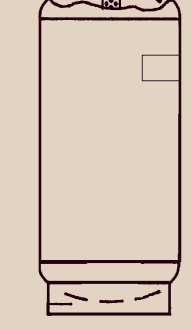

Two different units are now available and can be built to accept most alignment equipment designed for use on single post lifts. Both units are 60" rise, full hydraulic and fiberglass coated. One is designed for above ground tank installations and the other for in-ground tank installations.

Each order is custom-made with respect to the safety leg guide tube placement and bolt pattern required for the particular alignment rack. This information will need to be supplied by the lift professional prior to production. Typical lead times will range from 2-3 weeks in the beginning and should improve in time.

Each kit comes complete with the cylinder assembly, tank and valves. Contact Joel Schneider to discuss your requirements.

### 12-5/8" custom cylinder assemblies, a job well done!

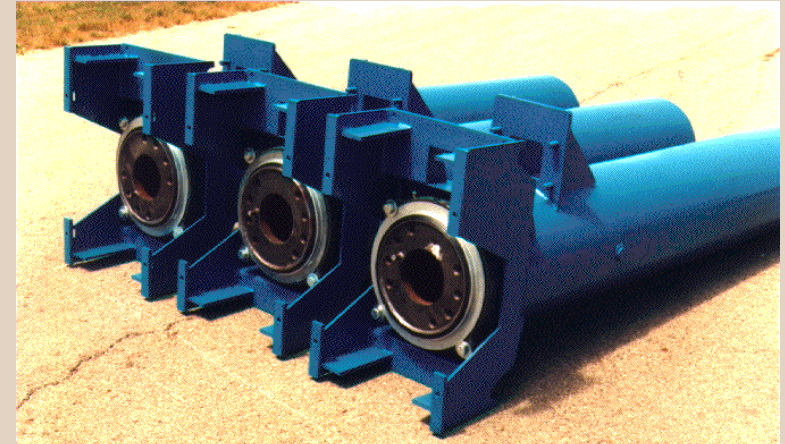

This past July we completed the second phase of a big job for a major transit authority. They were having trouble with the axle mounting steel structure distorting and welds breaking at the top of the casing. A sample cylinder assembly was furnished to SVI and we designed a new heavier duty cylinder assembly for them to try.

The bottom line: they liked the new stronger design so much they decided to replace all four 12-5/8" front recessed moveable assemblies. **SVI is your answer!**

# SVI SUPPORTS DISTRIBUTORS



SVI supplies its product line only to Lift Repair Professionals and **DOES NOT** sell to lift owners, end-users of lift repair products.

Unfortunately, there are other companies in this Industry that sell directly to lift owners, cutting out the Distributor. SVI believes this undermines Distributors, the back bone of our industry.

**This is wrong!**  
**For Distributor Support - SVI is your Answer!**



**SVI International, Inc.**  
**LIFT REPAIR PARTS**

**ATLANTA - BALTIMORE - CHICAGO - LOS ANGELES**

Main Office: 800 Hicks Drive • Elburn, Illinois 60119 • 800-321-8173 • Fax 800-899-1784



# The Twin Post

Update for the S V I Line of Automotive Service Equipment Repair Parts - August 1999



## 10<sup>th</sup> anniversary issue

### A brief look back

In December 1990 we moved into our current facility in Elburn, Illinois, just west of Chicago. The original building provided 8,200 square feet of warehouse space and 1,800 in office space.



Main office and warehouse facility

It was not long before we were cramped for space and started adding to the building. In mid 1994 we added 6,000 square feet to the warehouse and another 1,800 to the office. Just recently a 2,000 square foot mezzanine was added to the warehouse. We also expanded the offices to provide more space for your favorite SVI Sales Representatives.

### This issue:

Past highlights of *The Twin Post*

10 years ago and today

Looking ahead

Relief Valve: best of the past, maybe

Tenure worth noting

One source pricing

Equalizers and other parts for Joyce lifts

New handle kit

Special seals for **Weaver** lifts

Single post jack units

Powder coating

3 year power unit warranty

Custom cylinder assemblies

Cables and sheaves

In July 1991, to better serve our west coast customers, we opened a warehouse facility in Baldwin Park, California just east of Los Angeles.



Duarte, California facility

Just two years later we moved to our current location in Duarte, California. This move provided us with more space and easier freeway access for customers in the Los Angeles area.



Front door of Atlanta, Georgia facility

August 1, 1995 meant only one thing to SVI distributors in the Southeast; faster delivery times and lower freight costs. The Atlanta, Georgia warehouse location was our third and believe it or not was set up and running in only one week.



Linthicum Heights, Maryland facility

## svi "Direct Fit" brand products



Address Service Requested

SVI International, Inc.  
P.O. Box 70  
Elburn, IL 60119

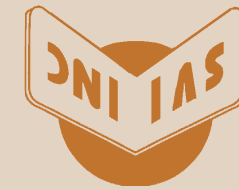

BULK RATE  
US Postage  
PAID  
Permit No. 134  
Carol Stream, IL

### Tenure worth noting

These people have been working hard for you everyday for at least **four years or better.**

- Valerie Lincoln Since 1980
- Nancy Rohrer Since 1980
- Doug Climenhaga Since 1984
- Darryl Duey Since 1990
- Nancy Umstead Since 1991
- Brad Snow Since 1991
- Debbie Banks Since 1992
- Pam Jahns Since 1993
- Sandy Hahn Since 1993
- Bill Wilkie Since 1993
- Joel Schneider Since 1994
- Steve Johnson Since 1994
- Esteban Arellano Since 1994
- Sal Sanchez Since 1994
- Drew Simpson Since 1995
- Warren Fincham Since 1995

## The first issue

### The Twin Post some past highlights

**Winter 1989 issue:** the addition of lift tanks was announced.

**Summer 1990 issue:** Leaksealer seal kits for Weaver lifts new to product line.

**Fall 1990 issue:** packing followers for Weaver lifts featured as front page news.

**Spring 1991 issue:** detailed the addition of ratchet parts for heavy duty Weaver fore and aft lifts.

**Summer 1991 issue:** you saw SVI break the surface by adding replacement power units and cables for above ground lifts.

**Spring 1992 issue:** covered the growing availability of repair parts for Rotary lifts.

**Summer 1992 issue:** carried news that SVI has repair parts for all Fenner Stone power units.

**Winter 1992/93 issue:** we said, put the steel back into the lifts by supplying steel sheaves for Rotary lifts instead of nylon.

**Fall 1993 issue:** helped distributors cope by covering O.S.H.A., E.P.A. and A.N.S.I. requirements as they apply or do not apply to the lift industry.

**January 1994 issue:** covered locking equalizer assemblies for Globe lifts.

**January 1995 issue:** you saw the addition of arm restraints for Benwil lifts.

**October 1996 issue:** we said, surface mount lift parts - call for everything except the concrete.

**October 1997 issue:** announced that with our four "Ready Ship" warehouses 85% of the distributors received two day or better standard UPS ground delivery.



In June of 1989 we were planning a newsletter. The only problem, we didn't have a name.

The objective was to inform distributors that we added side by side lift repair parts to our product line.

Since these lifts are often referred to as twin posts, Doug Climenhaga suggested we call the newsletter simply - The Twin Post. The rest was history.

The first issue debuted in August 1989 and since then we have published over 65 newsletters aptly named *The Twin Post*.

### New seal kit now available for heavy duty Weaver lifts

For many years SVI has been supplying a special seal kit for Weaver lifts.

This special kit was requested by a transit authority maintenance supervisor to meet a high pressure need. There must be other transit authorities out there that can also benefit from this kit. To increase your options, this kit is now available to all SVI distributors.

The **BH-1776-HD** is ideal for all 10-5/8" fore and aft lifts operating in pressure ranges between 250 and 350 PSI. They are less pliable and may be slightly more difficult to install but will handle the higher pressure ranges with great ease. Try one today!

### One source pricing

We will meet most any competitive price or advertised special. This means you can make one phone call to handle all your lift repair needs.

Call SVI to stretch your purchasing dollars, optimize your profits and receive the quality you expect.

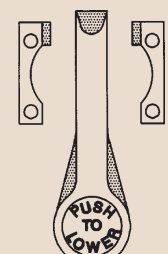

### Handle kit available for J.S. Barnes power units

Simplify your ordering when repairing bent handle brackets on Barnes power units. SVI supplies one simple kit which includes the handle, both brackets and the roll pin.

**BH-7009-15K** handle kits are in stock and priced to allow for a complete repair.

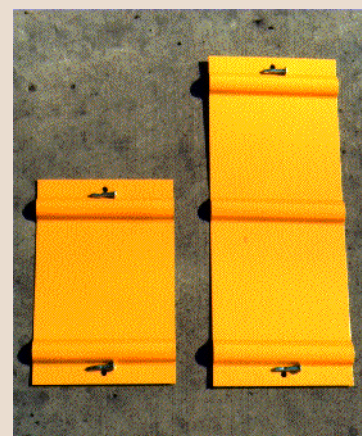

### Powder coating

SVI has begun powder coating some high wear parts to extend the finish life.

The steel wheel spotting dishes pictured left are an example of some parts we are now powder coating. We also powder coat the floor valve handles used on Weaver fore and aft lifts and certain sleeve and adapter assemblies.

Powder coating is rather unique process that provides for additional quality. First the parts go through two wash cycles to remove grease and oil. Next, they are phosphatized to prevent rust, then dried. Once dry, the parts are electrostatically sprayed with powder that is to become the actual color of the part. The final step is the baking. The parts are baked in a gas fired, infrared oven at 500° F. The parts then cool and are shipped to you or placed in our stock ready to meet your requirements.

### The Relief Valve - revisited

This humor was featured in past newsletters. It is the best from the past, maybe. See what you think.

What do you call the day after two days of continuous rain? MONDAY.

A road map will tell us everything we need to know except how to fold it up again.

The human brain starts working the moment you are born and never stops until you stand up to speak in public.

Sign in store: Helen Waite is the credit manager. If you want credit please go to Helen Waite.

One day a ham sandwich walked into a bar and asked for a drink. The bartender replied, "sorry, we do not serve food here."

Our football team was tough. After they sacked the quarterback they went after his whole family.

### Looking ahead

SVI strives continually for quality improvement. We are strongly considering or in the process of implementing the following:

**ISO9002** quality management system

**Website** with parts breakdowns and on-line ordering

**Internet e-mail** will allow us to efficiently communicate with customers and suppliers alike



### An assortment of cables and sheaves

SVI carries over 450 different cable assemblies for surface mount lifts. Customs can also be quickly produced to your specifications. Contact us today.

### All Joyce lifts can be repaired

SVI carries a complete line of repair parts for most all Joyce lifts. Call us when repairing single posts, side by sides or fore and afts. We have the parts to help your customers out.

In fact, four years ago we supplied a distributor with all the parts to rehab all the heavy duty lifts in Dayton, Ohio at the Miami Valley RTA facility. This job included replacement plungers, seals and safety parts.

When working on any Joyce lift - *SVI is your answer.*

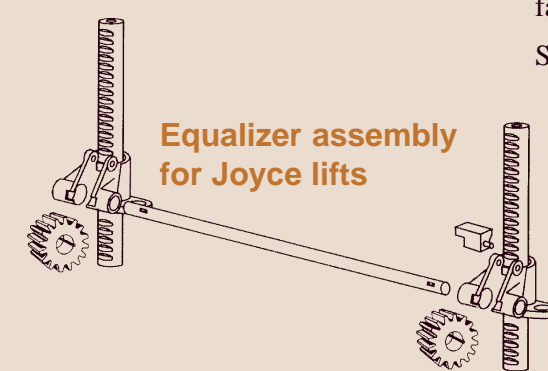

Equalizer assembly for Joyce lifts

### Rack bar guide tube insert for Weaver lifts

Avoid excavating! Replacement guide tube sleeves for Weaver side by side in-ground lifts are now a stock item. They are intended for use on Weaver lift models **EC-881** and **EC-885** using square (1-7/8" x 1-7/8") rack bars only.

Installation is easy. Simply clean out existing guide tube and insert the new sleeve. Each guide tube sleeve 3-1/8" x 80" long.

Ask for **BH-9612-SLV** to solve corroded rack bar guide tube problems for your customers.

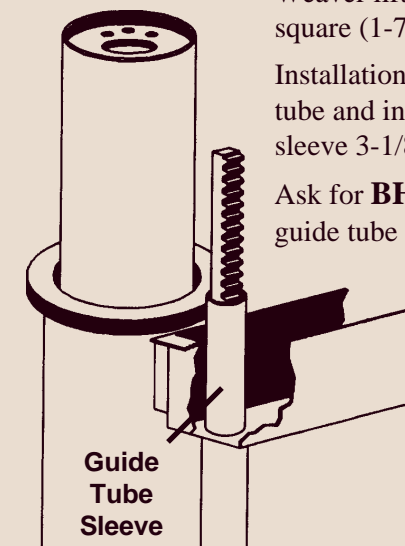

Guide Tube Sleeve

If you are going to excavate to correct a guide tube problem, fiberglass coated replacement guide tubes are available. Order **BH-9612-15FG** or consult with your favorite SVI Sales Representative.

### Auto lift power units, more options with SVI

Increase your warranty with new SPX power unit. All other new power units come with a standard one years parts only warranty. The SPX unit provides you with a full three years of replacement parts coverage.

The manufacturer says this unit is fully field proven and that it rivals anything else on the market today. They feature reliable, American made electric motors unlike some others producing power units for the lift industry. The reservoir provides for a full 3 gallons of usable capacity. All other specifications are equal to or greater than that of standard units currently on the market.

To increase your warranty option consult your favorite SVI sales representative.

SVI Part Number **BH-7008-10**



### SVI 10 years ago and today

**10 years ago:** we had one warehouse.

**Today:** there are actually five warehouses to serve you, two in Elburn.

**10 years ago:** there were only six of us.

**Today:** there are twenty eight of us working everyday to meet your needs.

**10 years ago:** we had no voice mail or automated phone system.

**Today:** we still have no voice mail or automated phone system, you get a person when you call SVI.

**10 years ago:** there were about 350 products available in our line.

**Today:** you have over 8,000 repair parts available as an SVI distributor.

**10 years ago:** we did not supply replacement lift cylinder assemblies and kits.

**Today:** heavy duty lift replacement cylinder assemblies and kits are a speciality.